

Artificial Neural Networks Applied to Stochastic Monte Carlo as a
Way to Approximate Modified Heat Equations, and Their
Associated Parameters.

Shakil Rafi

February 16, 2024

Contents

I	On Convergence of Brownian Motion Monte Carlo	4
1	Introduction.	5
1.1	Motivation	5
1.2	Notation, Definitions & Basic notions.	7
1.2.1	Norms and Inner Products	7
1.2.2	Probability Space and Brownian Motion	8
1.2.3	Lipschitz and Related Notions	10
1.2.4	Kolmogorov Equations	12
1.2.5	Linear Algebra Notation and Definitions	13
1.2.6	O -type Notation and Function Growth	15
1.2.7	The Concatenation of Vectors & Functions	17
2	Brownian Motion Monte Carlo	20
2.1	Brownian Motion Preliminaries	20
2.2	Monte Carlo Approximations	26
2.3	Bounds and Convergence	28
3	That u is a Viscosity Solution	36
3.1	Some Preliminaries	36
3.2	Viscosity Solutions	40
3.3	Solutions, Characterization, and Computational Bounds to the Kolmogorov Backward Equations	59

4	Brownian motion Monte Carlo of the non-linear case	65
II	A Structural Description of Artificial Neural Networks	67
5	Introduction and Basic Notions About Neural Networks	68
5.1	The Basic Definition of ANNs and instantiations of ANNs	68
5.2	Compositions of ANNs	71
5.2.1	Composition	72
5.3	Stacking of ANNs of Equal Depth	77
5.4	Stacking of ANNs of Unequal Depth	82
5.5	Affine Linear Transformations as ANNs and Their Properties.	83
5.6	Sums of ANNs of Same End-widths	86
5.6.1	Neural Network Sum Properties	88
5.6.2	Sum of ANNs of Unequal Depth But Same End-widths	94
5.7	Linear Combinations of ANNs and Their Properties	95
5.8	Neural Network Diagrams	106
6	ANN Product Approximations	108
6.1	Approximation for Products of Two Real Numbers	108
6.1.1	The squares of real numbers in $[0, 1]$	109
6.1.2	The Sqr network	117
6.1.3	The Prd network	122
6.2	Higher Approximations	127
6.2.1	The Tun Neural Networks and Their Properties	128
6.2.2	The Pwr Neural Networks and Their Properties	133
6.2.3	$\text{Pnm}_{n,C}^{q,\varepsilon}$ and Neural Network Polynomials.	143
6.2.4	$\text{Xpn}_n^{q,\varepsilon}$, $\text{Csn}_n^{q,\varepsilon}$, $\text{Sne}_n^{q,\varepsilon}$, and Neural Network Approximations of e^x , $\cos(x)$, and $\sin(x)$	147
7	A modified Multi-Level Picard and Associated Neural Network	156

8	ANN first approximations	159
8.1	ANN Representations for One-Dimensional Identity and some associated properties .	159
8.2	Trp^h , $\text{Etr}^{n,h}$ and Neural Network Approximations For the Trapezoidal Rule.	168
8.3	Linear Interpolation for Multi-Dimensional Functions	169
8.3.1	The Nrm_1^d Networks	169
8.3.2	The Mxm^d Neural Networks	171
8.3.3	The MC Neural Network and Approximations via Maximum Convolutions .	176
8.3.4	Lipschitz Function Approximations	181
8.3.5	Explicit ANN Approximations	183
III	A deep-learning solution for u and Brownian motions	185
9	ANN representations of Brownian Motion Monte Carlo	186
9.1	The $\text{E}_n^{N,h,q,\varepsilon}$ Neural Network	189
9.2	The $\text{UE}_{n,\mathbb{G}_d}^{N,h,q,\varepsilon}$ Neural Network	194
9.3	The $\text{UEX}_{n,\mathbb{G}_d,\omega_i}^{N,h,q,\varepsilon}$ network	198
9.4	The UES network	203
10	Conclusions and Further Research	211
10.1	Further operations and further kinds of neural networks	211
10.1.1	Mergers and Dropout	211
10.2	Code Listings	217

Part I

On Convergence of Brownian Motion

Monte Carlo

Chapter 1

Introduction.

1.1 Motivation

Artificial neural networks represent a sea change in computing. They have successfully been used in a wide range of applications, from protein-folding in [Tsaban et al. \(2022\)](#), knot theory in [Davies et al. \(2021\)](#), and extracting data from gravitational waves in [Zhao et al. \(2023\)](#).

As neural networks become more ubiquitous, we see that the number of parameters required to train them increases, which poses two problems: accessibility on low-power devices and the amount of energy needed to train these models, see for instance [Wu et al. \(2022\)](#) and [Strubell et al. \(2019\)](#). Parameter estimates become increasingly crucial in an increasingly climate-challenged world. That we know strict and precise upper bounds on parameter estimates tells us when training becomes wasteful, in some sense, and when, perhaps, different approaches may be needed.

Our goal in this dissertation is threefold:

- (i) Firstly, we will take something called Multi-Level Picard first introduced in [E et al. \(2019\)](#) and [E et al. \(2021\)](#), and in particular, the version of Multi-Level Picard that appears in [Hutzenthaler et al. \(2021\)](#). We show that dropping the drift term and substantially simplifying the process still results in convergence of the method and polynomial bounds for the number of computations required and rather nice properties for the approximations, such as integrability and measurability.

- (ii) We will then go on to realize that the solution to a modified version of the heat equation has a solution represented as a stochastic differential equation by Feynman-Kac and further that a version of this can be realized by the modified multi-level Picard technique mentioned in Item (i), with certain simplifying assumptions since we dropped the drift term. A substantial amount of this is inspired by [Beck et al. \(2021c\)](#) and much earlier work in [Karatzas and Shreve \(1991\)](#) and [Da Prato and Zabczyk \(2002\)](#).
- (iii) By far, the most significant part of this dissertation is dedicated to expanding and building upon a framework of neural networks as appears in [Grohs et al. \(2023\)](#). We modify this definition highly and introduce several new neural network architectures to this framework (Tay, Pwr, Trp, Tun, Etr, among others) and show, for all these neural networks, that the parameter count grows only polynomially as the accuracy of our model increases, thus beating the curse of dimensionality. This finally paves the way for giving neural network approximations to the techniques realized in Item (ii). We show that it is not too wasteful (defined on the polynomiality of parameter counts) to use neural networks to approximate MLP to approximate a stochastic differential equation equivalent to certain parabolic PDEs as Feynman-Kac necessitates.

We end this dissertation by proposing two avenues of further research: analytical and algebraic. This framework of understanding neural networks as ordered tuples of ordered pairs may be extended to give neural network approximation of classical PDE approximation techniques such as Runge-Kutta, Adams-Moulton, and Bashforth. We also propose three conjectures about neural networks, as defined in [Grohs et al. \(2023\)](#). They form a bimodule, and that realization is a functor.

This dissertation is broken down into three parts. At the end of each part, we will encounter tent-pole theorems, which will eventually lead to the final neural network approximation outcome. These tentpole theorems are [Theorem 2.3.4](#), [Theorem 3.3.1](#), and [Theorem](#). Finally, the culmination of these three theorems is [Theorem](#), the end product of the dissertation.

1.2 Notation, Definitions & Basic notions.

We introduce here basic notations that we will be using throughout this dissertation. Large parts are taken from standard literature inspired by *Matrix Computations* by Golub and Van Loan (2013), and *Probability: Theory & Examples* by Rick Durrett (2019).

1.2.1 Norms and Inner Products

Definition 1.2.1 (Euclidean Norm). Let $\|\cdot\|_E : \mathbb{R}^d \rightarrow [0, \infty)$ denote the Euclidean norm defined for every $d \in \mathbb{N}_0$ and for all $x = \{x_1, x_2, \dots, x_d\} \in \mathbb{R}^d$ as:

$$\|x\|_E = \left(\sum_{i=1}^d x_i^2 \right)^{\frac{1}{2}} \quad (1.2.1)$$

For the particular case that $d = 1$ and where it is clear from context, we will denote $\|\cdot\|_E$ as $|\cdot|$.

Definition 1.2.2 (Max Norm). Let $\|\cdot\|_\infty : \mathbb{R}^d \rightarrow [0, \infty)$ denote the max norm defined for every $d \in \mathbb{N}_0$ and for all $x = \{x_1, x_2, \dots, x_d\} \in \mathbb{R}^d$ as:

$$\|x\|_\infty = \max_{i \in \{1, 2, \dots, d\}} \{|x_i|\} \quad (1.2.2)$$

We will denote the max norm $\|\cdot\|_{\max} : \mathbb{R}^{m \times n} \rightarrow [0, \infty)$ defined for every $m, n \in \mathbb{N}$ and for all $A \in \mathbb{R}^{m \times n}$ as:

$$\|A\|_{\max} := \max_{\substack{i \in \{1, 2, \dots, m\} \\ j \in \{1, 2, \dots, n\}}} |[A]_{i,j}| \quad (1.2.3)$$

Definition 1.2.3 (Frobenius Norm). Let $\|\cdot\|_F : \mathbb{R}^{m \times n} \rightarrow [0, \infty)$ denote the Frobenius norm defined for every $m, n \in \mathbb{N}$ and for all $A \in \mathbb{R}^{m \times n}$ as:

$$\|A\|_F = \left(\sum_{i=1}^m \sum_{j=1}^n [A]_{i,j}^2 \right)^{\frac{1}{2}} \quad (1.2.4)$$

Definition 1.2.4 (Euclidean Inner Product). Let $\langle \cdot, \cdot \rangle : \mathbb{R}^d \times \mathbb{R}^d \rightarrow \mathbb{R}$ denote the Euclidean inner product defined for every $d \in \mathbb{N}$, for all $\mathbb{R}^d \ni x = \{x_1, x_2, \dots, x_d\}$, and for all $\mathbb{R}^d \ni y = \{y_1, y_2, \dots, y_d\}$

as:

$$\langle x, y \rangle = \sum_{i=1}^d (x_i y_i) \quad (1.2.5)$$

1.2.2 Probability Space and Brownian Motion

Definition 1.2.5 (Probability Space). *A probability space is a triple $(\Omega, \mathcal{F}, \mathbb{P})$ where:*

- (i) Ω is a set of outcomes called the **sample space**.
- (ii) \mathcal{F} is a set of events called the **event space**, where each event is a set of outcomes from the sample space. More specifically, it is a σ -algebra on the set Ω .
- (iii) A measurable function $\mathbb{P} : \mathcal{F} \rightarrow [0, 1]$ assigning each event in the **event space** a probability between 0 and 1. More specifically, \mathbb{P} is a measure on Ω with the caveat that the measure of the entire space is 1, i.e., $\mathbb{P}(\Omega) = 1$.

Definition 1.2.6 (Random Variable). *Let $(\Omega, \mathcal{F}, \mathbb{P})$ be a probability space, and let $d \in \mathbb{N}_0$. For some $d \in \mathbb{N}_0$ a random variable is a measurable function $\mathcal{X} : \Omega \rightarrow \mathbb{R}^d$.*

Definition 1.2.7 (Expectation). *Given a probability space $(\Omega, \mathcal{F}, \mathbb{P})$, the expected value of a random variable X , denoted $\mathbb{E}[X]$ is the Lebesgue integral given by:*

$$\mathbb{E}[X] = \int_{\Omega} X d\mathbb{P} \quad (1.2.6)$$

Definition 1.2.8 (Stochastic Process). *A stochastic process is a family of random variables over a fixed probability space $(\Omega, \mathcal{F}, \mathbb{R})$, indexed over a set, usually $[0, T]$ for $T \in (0, \infty)$.*

Definition 1.2.9 (Stochastic Basis). *A stochastic basis is a tuple $(\Omega, \mathcal{F}, \mathbb{P}, \mathbb{F})$ where:*

- (i) $(\Omega, \mathcal{F}, \mathbb{P})$ is a probability space equipped with a filtration \mathbb{F} where,
- (ii) $\mathbb{F} = (\mathcal{F}_i)_{i \in I}$, is a collection of non-decreasing sets under inclusion where for every $i \in I$, I being equipped in total order, it is the case that \mathcal{F}_i is a sub σ -algebra of \mathcal{F} .

Definition 1.2.10 (Brownian Motion Over a Stochastic Basis). *Given a stochastic basis $(\Omega, \mathcal{F}, \mathbb{P}, \mathbb{F})$ a standard $(\mathbb{F}_t)_{t \in [0, T]}$ -Brownian motion \mathcal{W}_t is a mapping $\mathcal{W}_t : [0, T] \times \Omega \rightarrow \mathbb{R}^d$ satisfying:*

- (i) \mathcal{W}_t is \mathcal{F}_t measurable for all $t \in [0, \infty)$
- (ii) $\mathcal{W}_0 = 0$ with \mathbb{P} -a.s.
- (iii) $\mathcal{W}_t - \mathcal{W}_s \sim \text{Norm}(0, t - s)$ when $s \in (0, t)$.
- (iv) $\mathcal{W}_t - \mathcal{W}_s$ is independent of \mathcal{W}_s whenever $s < t$.
- (v) The paths that \mathcal{W}_t take are \mathbb{P} -a.s. continuous.

Definition 1.2.11 ($(\mathbb{F}_t)_{t \in [0, T]}$ -adapted Stochastic Process). Let $T \in (0, \infty)$. Let $(\Omega, \mathcal{F}, \mathbb{P}, \mathbb{F})$ be a filtered probability space with the filtration indexed over $[0, T]$. Let (S, Σ) be a measurable space. Let $\mathcal{X} : [0, T] \times \Omega \rightarrow S$ be a stochastic process. We say that \mathcal{X} is an $(\mathbb{F}_t)_{t \in [0, T]}$ -adapted stochastic process if it is the case that $\mathcal{X}_t : \Omega \rightarrow S$ is (\mathcal{F}_t, Σ) measurable for each $t \in [0, T]$.

Definition 1.2.12 ($(\mathbb{F}_t)_{t \in [0, T]}$ -adapted stopping time). Let $T \in (0, \infty)$, $\tau \in [0, T]$. Assume a filtered probability space $(\Omega, \mathcal{F}, \mathbb{P}, \mathbb{F})$. It is then the case that $\tau \in \mathbb{R}$ is a stopping time if the stochastic process $\mathcal{X} = (\mathcal{X}_t)_{t \in [0, T]}$ define as:

$$\mathcal{X}_t := \begin{cases} 1 & : t < \tau \\ 0 & : t \geq \tau \end{cases} \quad (1.2.7)$$

is adapted to the filtration $\mathbb{F} := (\mathcal{F}_i)_{i \in [0, T]}$

Definition 1.2.13 (Strong Solution of Stochastic Differential Equation). Let $d, m \in \mathbb{N}$. Let $\mu : \mathbb{R}^d \rightarrow \mathbb{R}^d$, $\sigma : \mathbb{R}^d \rightarrow \mathbb{R}^{d \times m}$ be Borel-measurable. Let $(\Omega, \mathcal{F}, \mathbb{P}, (\mathbb{F}_t)_{t \in [0, T]})$ be a stochastic basis, and let $\mathcal{W} : [0, T] \times \Omega \rightarrow \mathbb{R}^d$ be a standard $(\mathbb{F}_t)_{t \in [0, T]}$ -Brownian motion. For all $t \in [0, T]$, $x \in \mathbb{R}^d$, let $\mathcal{X}^{t, x} = (\mathcal{X}_s^{t, x})_{s \in [t, T]} \times \Omega \rightarrow \mathbb{R}^d$ be an $(\mathbb{F}_s)_{s \in [t, T]}$ -adapted stochastic process with continuous sample paths satisfying that for all $t \in [0, T]$ we have \mathbb{P} -a.s. that:

$$\mathcal{X}^{t, x} = \mathcal{X}_0 + \int_0^t \mu(r, \mathcal{X}_r^{t, x}) dr + \int_0^t \sigma(r, \mathcal{X}_r^{t, x}) d\mathcal{W}_r \quad (1.2.8)$$

A strong solution to the stochastic differential equation (1.2.8) on probability space $(\Omega, \mathcal{F}, \mathbb{P}, (\mathbb{F}_t)_{t \in [0, T]})$,

w.r.t Brownian motion \mathcal{W} , w.r.t to initial condition $\mathcal{X}_0 = 0$ is a stochastic process $(\mathcal{X}_t)_{t \in [0, \infty)}$ satisfying that:

(i) \mathcal{X}_t is adapted to the filtration $(\mathbb{F}_t)_{t \in [0, T]}$.

(ii) $\mathbb{P}(\mathcal{X}_0 = 0) = 1$.

(iii) for all $t \in [0, T]$ it is the case that $\mathbb{P}\left(\int_0^t \|\mu(r, \mathcal{X}_r^{t,x})\|_E + \|\sigma(r, \mathcal{X}_r^{t,x})\|_F d\mathcal{W}_r < \infty\right) = 1$

(iv) it holds with \mathbb{P} -a.s. that \mathcal{X} satisfies the equation:

$$\mathcal{X}^{t,x} = \mathcal{X}_0 + \int_0^t \mu(r, \mathcal{X}_r^{t,x}) dr + \int_0^t \sigma(r, \mathcal{X}_r^{t,x}) d\mathcal{W}_r \quad (1.2.9)$$

Definition 1.2.14 (Strong Uniqueness Property for Solutions to Stochastic Differential Equations). *Let it be the case that whenever we have two strong solutions \mathcal{X} and $\tilde{\mathcal{X}}$, w.r.t. process \mathcal{W} and initial condition $\mathcal{X}_0 = 0$, as defined in Definition 1.2.13, it is also the case that $\mathbb{P}(\mathcal{X}_t = \tilde{\mathcal{X}}_t) = 1$ for all $t \in [0, T]$. We then say that the pair (μ, σ) exhibits a strong uniqueness property.*

1.2.3 Lipschitz and Related Notions

Definition 1.2.15 (Globally Lipschitz Function). *Let $d \in \mathbb{N}_0$. For every $d \in \mathbb{N}_0$, we say a function $f : \mathbb{R}^d \rightarrow \mathbb{R}^d$ is (globally) Lipschitz if there exists an $L \in (0, \infty)$ such that for all $x, y \in \mathbb{R}^d$ it is the case that :*

$$\|f(x) - f(y)\|_E \leq L \cdot \|x - y\|_E \quad (1.2.10)$$

The set of globally Lipschitz functions over set X will be denoted $\text{Lip}_G(X)$

Corollary 1.2.15.1. *Let $d \in \mathbb{N}_0$. For every $d \in \mathbb{N}_0$, a continuous function $f \in C(\mathbb{R}^d, \mathbb{R}^d)$ over a compact set $\mathcal{K} \subsetneq \mathbb{R}^d$ is Lipschitz over that set.*

Proof. By Heine-Cantor, f is uniformly continuous over set \mathcal{K} . Fix an arbitrary ϵ and let δ be from the definition of uniform continuity. By compactness we have a finite cover of \mathcal{K} by balls of radius

δ , centered around $x_i \in \mathcal{K}$:

$$\mathcal{K} \subseteq \bigcup_{i=1}^N B_\delta(x_i) \quad (1.2.11)$$

Note that within a given ball, no point x_j is such that $|x_i - x_j| > \delta$. Thus, by uniform continuity, we have the following:

$$|f(x_i) - f(x_j)| < \epsilon \quad \forall i, j \in \{1, 2, \dots, N\} \quad (1.2.12)$$

and thus let \mathfrak{L} be defined as:

$$\mathfrak{L} = \max_{\substack{i, j \in \{1, 2, \dots, N\} \\ i \neq j}} \left| \frac{f(x_i) - f(x_j)}{x_i - x_j} \right| \quad (1.2.13)$$

\mathfrak{L} satisfies the Lipschitz property. To see this, let x_1, x_2 be two arbitrary points within \mathcal{K} . Let $B_\delta(x_i)$ and $B_\delta(x_j)$ be two points such that $x_1 \in B_\delta(x_i)$ and $x_2 \in B_\delta(x_j)$. The triangle inequality then yields that:

$$\begin{aligned} |f(x_1) - f(x_2)| &\leq |f(x_1) - f(x_i)| + |f(x_i) - f(x_j)| + |f(x_j) - f(x_2)| \\ &\leq |f(x_i) - f(x_j)| + 2\epsilon \\ &\leq \mathfrak{L} \cdot |x_i - x_j| + 2\epsilon \\ &\leq \mathfrak{L} \cdot |x_1 - x_2| + 2\epsilon \end{aligned}$$

for all $\epsilon \in (0, \infty)$. □

Definition 1.2.16 (Locally Lipschitz Function). *Let $d \in \mathbb{N}_0$. For every $d \in \mathbb{N}_0$ a function $f : \mathbb{R}^d \rightarrow \mathbb{R}^d$ is locally Lipschitz if for all $x_0 \in \mathbb{R}^d$ there exists a compact set $\mathcal{K} \subseteq \text{Domain}(f)$ containing x_0 , and a constant $L \in (0, \infty)$ for that compact set such that*

$$\sup_{\substack{x, y \in \mathcal{K} \\ x \neq y}} \left\| \frac{f(x) - f(y)}{x - y} \right\|_E \leq L \quad (1.2.14)$$

The set of locally Lipschitz functions over set X will be denoted $\text{Lip}_L(X)$.

Corollary 1.2.16.1. *A function $f : \mathbb{R}^d \rightarrow \mathbb{R}^d$ that is globally Lipschitz is also locally Lipschitz. More concisely $\text{Lip}_G(X) \subsetneq \text{Lip}_L(X)$.*

Proof. Assume not, that is to say, there exists a point $x \in \text{Domain}(f)$, a compact set $\mathcal{K} \subseteq \text{Domain}(f)$, and points $x_1, x_2 \in \mathcal{K}$ such that:

$$\frac{|f(x_1) - f(x_2)|}{|x_1 - x_2|} \geq \mathfrak{L} \quad (1.2.15)$$

This directly contradicts Definition 1.2.15. □

1.2.4 Kolmogorov Equations

Definition 1.2.17 (Kolmogorov Equation). *We take our definition from (Da Prato and Zabczyk, 2002, (7.0.1)) with, $u \curvearrowright u$, $G \curvearrowright \sigma$, $F \curvearrowright \mu$, and $\varphi \curvearrowright g$, and for our purposes we set $A : \mathbb{R}^d \rightarrow 0$. Given a separable Hilbert space H (in our case \mathbb{R}^d), and letting $\mu : [0, T] \times \mathbb{R}^d \rightarrow \mathbb{R}^d$, $\sigma : [0, T] \times \mathbb{R}^d \rightarrow \mathbb{R}^{d \times m}$, and $g : \mathbb{R}^d \rightarrow \mathbb{R}$ be at least Lipschitz, a Kolmogorov Equation is an equation of the form:*

$$\begin{cases} \left(\frac{\partial}{\partial t} u \right) (t, x) = \frac{1}{2} \text{Trace} (\sigma (t, x) [\sigma (t, x)]^* (\text{Hess}_x u) (t, x)) + \langle \mu (t, x), (\nabla_x u) (t, x) \rangle \\ u(0, x) = g(x) \end{cases} \quad (1.2.16)$$

Definition 1.2.18 (Strict Solution to Kolmogorov Equation). *Let $d \in \mathbb{N}_0$. For every $d \in \mathbb{N}_0$ a function $u : [0, T] \times \mathbb{R}^d \rightarrow \mathbb{R}$ is a strict solution to (1.2.16) if and only if:*

(i) $u \in C^{1,1}([0, T] \times \mathbb{R}^d)$ and $u(0, \cdot) = g$

(ii) $u(t, \cdot) \in UC^{1,2}([0, T] \times \mathbb{R}^d, \mathbb{R})$

(iii) For all $x \in \text{Domain}(A)$, $u(\cdot, x)$ is continuously differentiable on $[0, \infty)$ and satisfies (1.2.16).

Definition 1.2.19 (Generalized Solution to Kolmogorov Equation). *A generalized solution to (1.2.16) is defined as:*

$$u(t, x) = \mathbb{E} [g(\mathcal{X}^{t,x})] \quad (1.2.17)$$

Where the stochastic process $\mathcal{X}^{t,x}$ is the solution to the stochastic differential equation, for $x \in \mathbb{R}^d$,

$t \in [0, T]$:

$$\mathcal{X}^{t,x} = \int_0^t \mu(\mathcal{X}_r^{t,x}) dr + \int_0^t \sigma(\mathcal{X}_r^{t,x}) dW_r \quad (1.2.18)$$

Definition 1.2.20 (Laplace Operator w.r.t. x). *Let $d \in \mathbb{N}_0$, and $f \in C^2(\mathbb{R}^d, \mathbb{R})$. For every $d \in \mathbb{N}_0$, the Laplace operator $\nabla_x^2 : C^2(\mathbb{R}^d, \mathbb{R}) \rightarrow \mathbb{R}$ is defined as:*

$$\Delta_x f = \nabla_x^2 f := \nabla \cdot \nabla f = \sum_{i=1}^d \frac{\partial^2 f}{\partial x_i^2} \quad (1.2.19)$$

1.2.5 Linear Algebra Notation and Definitions

Definition 1.2.21 (Identity, Zero Matrix, and the 1-matrix). *Let $d \in \mathbb{N}$. We will define the identity matrix for every $d \in \mathbb{N}$ as the matrix $\mathbb{I}_d \in \mathbb{R}^{d \times d}$ given by:*

$$\mathbb{I}_d = [\mathbb{I}_d]_{i,j} = \begin{cases} 1 & i = j \\ 0 & \text{else} \end{cases} \quad (1.2.20)$$

Note that $\mathbb{I}_1 = 1$.

Let $m, n, i, j \in \mathbb{N}$. For every $m, n \in \mathbb{N}$, $i \in \{1, 2, \dots, m\}$, and $j \in \{1, 2, \dots, n\}$ we define the zero matrix $\mathbb{0}_{m,n} \in \mathbb{R}^{m \times n}$ as:

$$\mathbb{0}_{m,n} = [\mathbb{0}_{m,n}]_{i,j} = 0 \quad (1.2.21)$$

Where we only have a column of zeros, it is convenient to denote $\mathbb{0}_d$ where d is the height of the column.

Let $m, n, i, j \in \mathbb{N}$. For every $m, n \in \mathbb{N}$, $i \in \{1, 2, \dots, m\}$, and $j \in \{1, 2, \dots, n\}$ we define matrix of ones $\mathbb{e}_{m,n} \in \mathbb{R}^{m \times n}$ as:

$$\mathbb{e}_{m,n} = [\mathbb{e}]_{i,j} = 1 \quad (1.2.22)$$

Where we only have a column of ones, it is convenient to denote \mathbb{e}_d where d is the height of the column.

Definition 1.2.22 (Single-entry matrix). Let $m, n, k, l \in \mathbb{N}$ and let $c \in \mathbb{R}$. For $k \in \mathbb{N} \cap [1, m]$ and $l \in \mathbb{N} \cap [1, n]$, we will denote by $\mathbb{k}_{k,l,c}^{m,n} \in \mathbb{R}^{m \times n}$ as the matrix defined by:

$$\mathbb{k}_{k,l,c}^{m,n} = \left[\mathbb{k}_{k,l}^{m,n} \right]_{i,j} = \begin{cases} c & : k = i \wedge l = j \\ 0 & : \text{else} \end{cases} \quad (1.2.23)$$

Definition 1.2.23 (Complex conjugate and transpose). Let $m, n, i, j \in \mathbb{N}$, and $A \in \mathbb{C}^{m \times n}$. For every $m, n \in \mathbb{N}$, $i \in \{1, 2, \dots, m\}$ and $j \in \{1, 2, \dots, n\}$, we denote by $A^* \in \mathbb{C}^{n \times m}$ the matrix:

$$A^* := [A^*]_{i,j} = \overline{[A]_{j,i}} \quad (1.2.24)$$

Where it is clear that we are dealing with real matrices, i.e., $A \in \mathbb{R}^{m \times n}$, we will denote this as A^\top .

Definition 1.2.24 (Column and Row Notation). Let $m, n, i, j \in \mathbb{N}$ and let $A \in \mathbb{R}^{m \times n}$. For every $m, n \in \mathbb{N}$ and $i \in \{1, 2, \dots, m\}$ we denote i -th row as:

$$[A]_{i,*} = \left[a_{i,1} \quad a_{i,2} \quad \cdots \quad a_{i,n} \right] \quad (1.2.25)$$

Similarly for every $m, n \in \mathbb{N}$ and $j \in \{1, 2, \dots, n\}$, we done the j -th row as:

$$[A]_{*,j} = \begin{bmatrix} a_{1,j} \\ a_{2,j} \\ \vdots \\ a_{m,j} \end{bmatrix} \quad (1.2.26)$$

Definition 1.2.25 (Component-wise notation). Let $m, n, i, j \in \mathbb{N}$, and let $A \in \mathbb{R}^{m \times n}$. Let $f : \mathbb{R} \rightarrow \mathbb{R}$. For all $m, n \in \mathbb{N}$, $i \in \{1, 2, \dots, m\}$, and $j \in \{1, 2, \dots, n\}$ we will define $f \left([A]_{*,*} \right) \in \mathbb{R}^{m \times n}$ as:

$$f \left([A]_{*,*} \right) := \left[f \left([A]_{i,j} \right) \right]_{i,j} \quad (1.2.27)$$

Thus under this notation the component-wise square of A is $\left([A]_{*,*} \right)^2$, the component-wise sin is $\sin \left([A]_{*,*} \right)$ and the Hadamard product of $A, B \in \mathbb{R}^{m \times n}$ then becomes $A \odot B = [A]_{*,*} \times [B]_{*,*}$.

Remark 1.2.26. Where we are dealing with a row vector $x \in \mathbb{R}^{d \times 1}$ and it is evident from the context we may choose to write $f([x]_*)$.

Definition 1.2.27 (The Diagonalization Operator). Let $m_1, m_2, n_1, n_2 \in \mathbb{N}$. Given $A \in \mathbb{R}^{m_1 \times n_1}$ and $B \in \mathbb{R}^{m_2 \times n_2}$, we will denote by $\text{diag}(A, B)$ the matrix:

$$\text{diag}(A, B) = \begin{bmatrix} A & \mathbb{0}_{m_1, n_2} \\ \mathbb{0}_{m_2, n_1} & B \end{bmatrix} \quad (1.2.28)$$

Remark 1.2.28. $\text{diag}(A_1, A_2, \dots, A_n)$ is defined analogously for a finite set of matrices A_1, A_2, \dots, A_n .

Definition 1.2.29 (Number of rows and columns notation). Let $m, n \in \mathbb{N}$. Let $A \in \mathbb{R}^{m \times n}$. Let $\text{rows} : \mathbb{R}^{m \times n} \rightarrow \mathbb{N}$ and $\text{columns} : \mathbb{R}^{m \times n} \rightarrow \mathbb{N}$, be the functions respectively $\text{rows}(A) = m$ and $\text{columns}(A) = n$.

1.2.6 O-type Notation and Function Growth

Definition 1.2.30 (O-type notation). Let $g \in C(\mathbb{R}, \mathbb{R})$. We say that $f \in C(\mathbb{R}, \mathbb{R})$ is in $O(g(x))$, denoted $f \in O(g(x))$, if there exists $c \in (0, \infty)$ and $x_0 \in (0, \infty)$ such that for all $x \in [x_0, \infty)$ it is the case that:

$$0 \leq f(x) \leq c \cdot g(x) \quad (1.2.29)$$

We say that $f \in \Omega(g(x))$ if there exists $c \in (0, \infty)$ and $x_0 \in (0, \infty)$ such that for all $x \in [x_0, \infty)$ it is the case that:

$$0 \leq cg(x) \leq f(x) \quad (1.2.30)$$

We say that $f \in \Theta(g(x))$ if there exists $c_1, c_2, x_0 \in (0, \infty)$ such that for all $x \in [x_0, \infty)$ it is the case that:

$$0 \leq c_1g(x) \leq f \leq c_2g(x) \quad (1.2.31)$$

Corollary 1.2.30.1 (Bounded functions and O-type notation). Let $f(x) \in C(\mathbb{R}, \mathbb{R})$, then:

(i) if f is bounded above for all $x \in \mathbb{R}$, it is in $O(1)$ for some constant $c \in \mathbb{R}$.

(ii) if f is bounded below for all $x \in \mathbb{R}$, it is in $\Omega(1)$ for some constant $c \in \mathbb{R}$.

(iii) if f is bounded above and below for all $x \in \mathbb{R}$, it is in $\Theta(1)$ for some constant $c \in \mathbb{R}$.

Proof. Assume $f \in C(\mathbb{R}, \mathbb{R})$, then:

(i) Assume for all $x \in \mathbb{R}$ it is the case that $f(x) \leq M$ for some $M \in \mathbb{R}$, then there exists an $x_0 \in (0, \infty)$ such that for all $x \in (x_0, \infty)$ it is also the case that $0 \leq f(x) \leq M$, whence $f(x) \in O(1)$.

(ii) Assume for all $x \in \mathbb{R}$ it is the case that $f(x) \geq M$ for some $M \in \mathbb{R}$, then there exists an $x_0 \in (0, \infty)$ such that for all $x \in [x_0, \infty)$ it is also the case that $f(x) \geq M \geq 0$, whence $f(x) \in \Omega(1)$.

(iii) This is a consequence of items (i) and (ii).

□

Corollary 1.2.30.2. Let $n \in \mathbb{N}_0$. For some $n \in \mathbb{N}_0$, let $f \in O(x^n)$. It is then also the case that $f \in O(x^{n+1})$.

Proof. Let $f \in O(x^n)$. Then there exists $c_0, x_0 \in (0, \infty)$, such that for all $x \in [x_0, \infty)$ it is the case that:

$$f(x) \leq c_0 \cdot x^n \tag{1.2.32}$$

Note however that for all $n \in \mathbb{N}_0$, there also exists $c_1, x_1 \in (0, \infty)$ such that for all $x \in (x_1, \infty)$ it is the case that:

$$x^n \leq c_1 \cdot x^{n+1} \tag{1.2.33}$$

Thus taken together this implies that for all $x \in (\max\{x_0, x_1\}, \infty)$ it is the case that:

$$f(x) \leq c_0 \cdot x^n \leq c_0 \cdot c_1 \cdot x^{n+1} \tag{1.2.34}$$

□

Definition 1.2.31 (The floor and ceiling functions). We denote by $\lfloor \cdot \rfloor : \mathbb{R} \rightarrow \mathbb{Z}$ and $\lceil \cdot \rceil : \mathbb{R} \rightarrow \mathbb{Z}$ the functions satisfying for all $x \in \mathbb{R}$ that $\lfloor x \rfloor = \max(\mathbb{Z} \cap (-\infty, x])$ and $\lceil x \rceil = \min(\mathbb{Z} \cap (-\infty, x])$.

1.2.7 The Concatenation of Vectors & Functions

Definition 1.2.32 (Vertical Vector Concatenation). Let $m, n \in \mathbb{N}$. Let $x = [x_1 \ x_2 \ \dots \ x_m]^\top \in \mathbb{R}^m$ and $y = [y_1, y_2, \dots, y_n]^\top \in \mathbb{R}^n$. For every $m, n \in \mathbb{N}$, we will denote by $x \frown y \in \mathbb{R}^m \times \mathbb{R}^n$ the vector given as:

$$\begin{bmatrix} x_1 \\ x_2 \\ \vdots \\ x_m \\ y_1 \\ y_2 \\ \vdots \\ y_n \end{bmatrix} \tag{1.2.35}$$

Remark 1.2.33. We will stipulate that when concatenating vectors as $x_1 \frown x_2$, x_1 is on top, and x_2 is at the bottom.

Corollary 1.2.33.1. Let $m_1, m_2, n_1, n_2 \in \mathbb{N}$ and let $x \in \mathbb{R}^{m_1}$, $y \in \mathbb{R}^{n_1}$, $\mathfrak{x} \in \mathbb{R}^{m_2}$, and $\mathfrak{y} \in \mathbb{R}^{n_2}$. It is then the case that $[x \frown \mathfrak{x}] + [y \frown \mathfrak{y}] = [x + y] \frown [\mathfrak{x} + \mathfrak{y}]$.

Proof. This follows straightforwardly from the fact that:

$$\begin{aligned}
 [x \frown \mathfrak{x}] + [y + \mathfrak{y}] &= \begin{bmatrix} x_1 \\ x_2 \\ \vdots \\ x_{m_1} \\ \mathfrak{x}_1 \\ \mathfrak{x}_2 \\ \vdots \\ \mathfrak{x}_{m_2} \end{bmatrix} + \begin{bmatrix} y_1 \\ y_2 \\ \vdots \\ y_{n_1} \\ \mathfrak{y}_1 \\ \mathfrak{y}_2 \\ \vdots \\ \mathfrak{y}_{n_2} \end{bmatrix} = \begin{bmatrix} x_1 + y_1 \\ x_2 + y_2 \\ \vdots \\ x_{m_1+n_1+1} \\ \mathfrak{x}_1 + \mathfrak{y}_1 \\ \mathfrak{x}_2 + \mathfrak{y}_2 \\ \vdots \\ \mathfrak{x}_{m_2} + \mathfrak{y}_{n_2} \end{bmatrix} = [x + y] \frown [\mathfrak{x} + \mathfrak{y}] \quad (1.2.36)
 \end{aligned}$$

□

Definition 1.2.34 (Function Concatenation). *Let $m_1, n_1, m_2, n_2 \in \mathbb{N}$. Let $f : \mathbb{R}^{m_1} \rightarrow \mathbb{R}^{n_1}$ and $g : \mathbb{R}^{m_2} \rightarrow \mathbb{R}^{n_2}$. We will denote by $f \frown g : \mathbb{R}^{m_1} \times \mathbb{R}^{m_2} \rightarrow \mathbb{R}^{n_1} \times \mathbb{R}^{n_2}$ as the function given for all $x = \{x_1, x_2, \dots, x_{m_1}\} \in \mathbb{R}^{m_1}$, $\bar{x} \in \{\bar{x}_1, \bar{x}_2, \dots, \bar{x}_{m_2}\} \in \mathbb{R}^{m_2}$, and $x \frown \bar{x} = \{x_1, x_2, \dots, x_{m_1}, \bar{x}_1, \bar{x}_2, \dots, \bar{x}_{m_2}\} \in \mathbb{R}^{m_1} \times \mathbb{R}^{m_2}$ by:*

$$\begin{aligned}
 \begin{bmatrix} x_1 \\ x_2 \\ \vdots \\ x_{m_1} \\ \bar{x}_1 \\ \bar{x}_2 \\ \vdots \\ \bar{x}_{m_2} \end{bmatrix} &\longrightarrow \begin{bmatrix} f(x) \\ g(\bar{x}) \end{bmatrix} \quad (1.2.37)
 \end{aligned}$$

Corollary 1.2.34.1. *Let $m, n \in \mathbb{N}$. Let $x_1 \in \mathbb{R}^m, x_2 \in \mathbb{R}^n$, and $f \in C(\mathbb{R}, \mathbb{R})$. It is then the case that $f(x_1 \frown x_2) = f(x_1) \frown f(x_2)$.*

Proof. This follows straightforwardly from the definition of function concatenation. □

Lemma 1.2.35. *Let $m_1, m_2, n_1, n_2 \in \mathbb{N}$. Let $f \in C(\mathbb{R}^{m_1}, \mathbb{R}^{n_1})$ and $g \in C(\mathbb{R}^{m_2}, \mathbb{R}^{n_2})$. It is then also the case that $f \frown g \in C(\mathbb{R}^{m_1} \times \mathbb{R}^{n_1}, \mathbb{R}^{m_2} \times \mathbb{R}^{n_2})$.*

Proof. Let $\mathbb{R}^{m_2} \times \mathbb{R}^{n_2}$ be equipped with the usual product topology, i.e., the topology generated by all products $X \times Y$ of open subsets $X \in \mathbb{R}^{m_2}$ and $Y \in \mathbb{R}^{n_2}$. In such a case let $V \subsetneq \mathbb{R}^{m_2} \times \mathbb{R}^{n_2}$ be an open subset. Then let it be that V_f and V_g are the canonical projections to the first and second factors respectively. Since projection under the usual topology is continuous, it is the case that $V_f \subsetneq \mathbb{R}^{m_2}$ and $V_g \subsetneq \mathbb{R}^{n_2}$ are open sets, respectively. As such it is then also the case that $f^{-1}(V_f) \subsetneq \mathbb{R}^{m_1}$ and $g^{-1}(V_g) \subsetneq \mathbb{R}^{n_1}$ are open sets as well by continuity of f and g . Thus, their product is open as well, proving the lemma. □

Chapter 2

Brownian Motion Monte Carlo

2.1 Brownian Motion Preliminaries

We will present here some standard invariants of Brownian motions. The proofs are standard and can be found in for instance [Durrett \(2019\)](#) and [Karatzas and Shreve \(1991\)](#).

Lemma 2.1.1 (Markov property of Brownian motions). *Let $T \in \mathbb{R}$, $t \in [0, T]$, and $d \in \mathbb{N}$. Let $(\Omega, \mathcal{F}, \mathbb{P})$ be a probability space. Let $\mathcal{W}_t : [0, T] \times \Omega \rightarrow \mathbb{R}^d$ be a standard Brownian motion. Fix $s \in [0, \infty)$. Let $\mathfrak{W}_t = \mathcal{W}_{s+t} - \mathcal{W}_s$. Then $\mathfrak{W} = \{\mathfrak{W}_t : t \in [0, \infty)\}$ is also a standard Brownian motion independent of \mathcal{W} .*

Proof. We check against the Brownian motion axioms. First note that $\mathfrak{W}_0 = \mathcal{W}_{s+0} - \mathcal{W}_s = 0$ with \mathbb{P} -a.s.

Note that $t \mapsto \mathcal{W}_{s+t} - \mathcal{W}_s$ is \mathbb{P} -a.s. continuous as it is the difference of two functions that are also \mathbb{P} -a.s. continuous.

Note next that for $h \in (0, \infty)$ it is the case that:

$$\begin{aligned} \mathbb{E}[\mathfrak{W}_{t+h} - \mathfrak{W}_t] &= \mathbb{E}[\mathcal{W}_{s+t+h} - \mathcal{W}_{s+h} - \mathcal{W}_{s+t} + \mathcal{W}_s] \\ &= \mathbb{E}[\mathcal{W}_{s+t+h} - \mathcal{W}_{s+t}] - \mathbb{E}[\mathcal{W}_{s+h} - \mathcal{W}_s] \\ &= 0 - 0 = 0 \end{aligned} \tag{2.1.1}$$

We note finally that:

$$\begin{aligned}
\text{Var} [\mathfrak{W}_{t+h} - \mathfrak{W}_t] &= \text{Var} [\mathcal{W}_{s+t+h} - \mathcal{W}_s - \mathcal{W}_{s+t} + \mathcal{W}_s] \\
&= \text{Var} [\mathcal{W}_{s+t+h} - \mathcal{W}_{s+t}] - \text{Var} [\mathcal{W}_s - \mathcal{W}_s] + \text{Cov} (\mathcal{W}_{s+t+h} - \mathcal{W}_{s+t}, \mathcal{W}_{s+h} - \mathcal{W}_s) \\
&= h - 0 = h
\end{aligned}$$

Finally note that two stochastic processes \mathcal{W} , \mathcal{X} are independent whenever given a set of sample points $t_1, t_2, \dots, t_n \in [0, T]$ it is the case that the vectors $[\mathcal{W}_{t_1}, \mathcal{W}_{t_2}, \dots, \mathcal{W}_{t_n}]^\top$ and $[\mathcal{X}_{t_1}, \mathcal{X}_{t_2}, \dots, \mathcal{X}_{t_n}]^\top$ are independent vectors.

That being the case note that the independent increments property of Brownian motions yields that, $\mathcal{W}_{s+t_1} - \mathcal{W}_s, \mathcal{W}_{s+t_2} - \mathcal{W}_s, \dots, \mathcal{W}_{s+t_n} - \mathcal{W}_s$ is independent of $\mathcal{W}_{t_1}, \mathcal{W}_{t_2}, \dots, \mathcal{W}_{t_n}$, i.e. \mathfrak{W} and \mathcal{W} are independent. \square

Lemma 2.1.2 (Independence of Brownian Motion). *Let $T \in (0, \infty)$. Let $(\Omega, \mathcal{F}, \mathbb{P})$ be a probability space. Let $\mathcal{X}, \mathcal{Y} : [0, T] \times \Omega \rightarrow \mathbb{R}^d$ be standard Brownian motions. It is then the case that they are independent of each other.*

Proof. We say that two Brownian motions are independent of each other if given a sampling vector of times (t_1, t_2, \dots, t_n) , the vectors $(\mathcal{X}_{t_1}, \mathcal{X}_{t_2}, \dots, \mathcal{X}_{t_n})$ and $(\mathcal{Y}_{t_1}, \mathcal{Y}_{t_2}, \dots, \mathcal{Y}_{t_n})$ are independent. As such let $n \in \mathbb{N}$ and let (t_1, t_2, \dots, t_n) be a vector of times with samples as given above. Consider now a new Brownian motion $\mathcal{X} - \mathcal{Y}$, wherein our samples are now $(\mathcal{X}_{t_1} - \mathcal{Y}_{t_1}, \mathcal{X}_{t_2} - \mathcal{Y}_{t_2}, \dots, \mathcal{X}_{t_n} - \mathcal{Y}_{t_n})$. By the independence property of Brownian motions, these increments must be independent of each other. Whence it is the case that the vectors $(\mathcal{X}_{t_1}, \mathcal{X}_{t_2}, \dots, \mathcal{X}_{t_n})$ and $(\mathcal{Y}_{t_1}, \mathcal{Y}_{t_2}, \dots, \mathcal{Y}_{t_n})$ are independent. \square

Lemma 2.1.3 (Scaling Invariance). *Let $T \in \mathbb{R}$, $t \in [0, T]$, and $d \in \mathbb{N}$. Let $(\Omega, \mathcal{F}, \mathbb{P})$ be a probability space. Let $\mathcal{W}_t : [0, T] \times \Omega \rightarrow \mathbb{R}^d$ be a standard Brownian motion. Let $a \in \mathbb{R} \setminus \{0\}$. It is then the case that $\mathcal{X}_t := \frac{1}{a} \mathcal{W}_{a^2 t}$ is also a standard Brownian motion.*

Proof. We check against the Brownian motion axioms. Note for instance that the function $t \mapsto \mathcal{X}_t$ is a product of a constant with a function that is \mathbb{P} -a.s. continuous yielding a function that is also \mathbb{P} -a.s. continuous.

Note also for instance that $\mathcal{X}_0 = \frac{1}{a} \cdot \mathcal{W}_{a^2,0} = 0$ with \mathbb{P} -a.s.

Note that for all $h \in (0, \infty)$, and $t \in [0, T]$ it is the case that:

$$\begin{aligned} \mathbb{E}[\mathcal{X}_{t+h} - \mathcal{X}_t] &= \mathbb{E}\left[\frac{1}{a}\mathcal{W}_{a^2.(t+h)} - \frac{1}{a}\mathcal{W}_{a^2.t}\right] \\ &= \frac{1}{a}\mathbb{E}[\mathcal{W}_{a^2.(t+h)} - \mathcal{W}_{a^2.t}] \\ &= 0 \end{aligned}$$

Note that for all $h \in (0, \infty)$, and $t \in [0, T]$ it is the case that:

$$\begin{aligned} \text{Var}[\mathcal{X}_{t+h} - \mathcal{X}_t] &= \text{Var}\left[\frac{1}{a}\mathcal{W}_{a^2.(t+h)} - \frac{1}{a}\mathcal{W}_{a^2.t}\right] \\ &= \frac{1}{a^2}\text{Var}[\mathcal{W}_{a^2.(t+h)} - \mathcal{W}_{a^2.t}] \\ &= \frac{1}{a^2} \cancel{a^2} (t+h-t) \\ &= h \end{aligned} \tag{2.1.2}$$

Finally note that for $t \in [0, T]$ and $s \in [0, t)$ it is the case that $\mathcal{W}_{a^2.t} - \mathcal{W}_{a^2.s}$ is independent of $\mathcal{W}_{a^2.s}$. Whence it is also the case that $\mathcal{X}_t - \mathcal{X}_s$ is independent of \mathcal{X}_s . \square

Lemma 2.1.4 (Summation of Brownian Motions). *Let $T \in \mathbb{R}$, $t \in [0, T]$ and $d \in \mathbb{N}$. Let $(\Omega, \mathcal{F}, \mathbb{P})$ be a probability space. Let $\mathcal{W}_t, \mathcal{X}_t : [0, T] \times \Omega \rightarrow \mathbb{R}^d$ be a standard independent Brownian motions. It is then the case that the process \mathcal{Y}_t defined as $\mathcal{Y}_t = \frac{1}{\sqrt{2}}(\mathcal{W}_t + \mathcal{X}_t)$ is also a standard Brownian motion.*

Proof. Note that $t \mapsto \frac{1}{\sqrt{2}}(\mathcal{W}_t + \mathcal{X}_t)$ is \mathbb{P} -a.s. continuous as it is the linear combination of two functions that are also \mathbb{R} -a.s. continuous.

Note also that $\mathcal{Y}_0 = \frac{1}{\sqrt{2}}(\mathcal{W}_0 + \mathcal{X}_0) = 0 + 0 = 0$ with \mathbb{P} -a.s.

Note that for all $h \in (0, \infty)$ and $t \in [t, T]$ it is the case that:

$$\begin{aligned} \mathbb{E} \left[\frac{1}{\sqrt{2}} (\mathcal{Y}_{t+h} - \mathcal{Y}_t) \right] &= \mathbb{E} \left[\frac{1}{\sqrt{2}} (\mathcal{W}_{t+h} + \mathcal{X}_{t+h} - \mathcal{W}_t - \mathcal{X}_t) \right] \\ &= \frac{1}{\sqrt{2}} \mathbb{E} [\mathcal{W}_{t+h} - \mathcal{W}_t] + \frac{1}{\sqrt{2}} \mathbb{E} [\mathcal{X}_{t+h} - \mathcal{X}_t] \\ &= 0 \end{aligned}$$

Note that for all $h \in (0, \infty)$, and $t \in [0, T]$ it is the case that:

$$\begin{aligned} \text{Var} \left[\frac{1}{\sqrt{2}} (\mathcal{Y}_{t+h} - \mathcal{Y}_t) \right] &= \text{Var} \left[\frac{1}{\sqrt{2}} (\mathcal{W}_{t+h} + \mathcal{X}_{t+h} - \mathcal{W}_t - \mathcal{X}_t) \right] \\ &= \text{Var} \left[\frac{1}{\sqrt{2}} (\mathcal{W}_{t+h} - \mathcal{W}_t) + \frac{1}{\sqrt{2}} (\mathcal{X}_{t+h} - \mathcal{X}_t) \right] \\ &= \frac{1}{2} \text{Var} [\mathcal{W}_{t+h} - \mathcal{W}_t] + \frac{1}{2} \text{Var} [\mathcal{X}_{t+h} - \mathcal{X}_t] + \underline{\text{Cov}(\mathcal{W}, \mathcal{X})} \\ &= h \end{aligned}$$

□

Definition 2.1.5 (Of \mathfrak{k}). *Let $p \in [2, \infty)$. We denote by $\mathfrak{k}_p \in \mathbb{R}$ the real number given by $\mathfrak{k} := \inf\{c \in \mathbb{R}\}$ where it holds that for every probability space $(\Omega, \mathcal{F}, \mathbb{P})$ and every random variable $\mathcal{X} : \Omega \rightarrow \mathbb{R}$ with $\mathbb{E}[|\mathcal{X}|] < \infty$ that $(\mathbb{E}[|\mathcal{X} - \mathbb{E}[\mathcal{X}]|^p])^{\frac{1}{p}} \leq c (\mathbb{E}[|\mathcal{X}|^p])^{\frac{1}{p}}$.*

Definition 2.1.6 (Primary Setting). *Let $d, m \in \mathbb{N}$, $T, \mathfrak{L}, p \in [0, \infty)$, $\mathfrak{p} \in [2, \infty)$ $\mathfrak{m} = \mathfrak{k}_p \sqrt{\mathfrak{p} - 1}$, $\Theta = \mathbb{Z}$, $g \in C(\mathbb{R}^d, \mathbb{R})$, assume for all $t \in [0, T]$, $x \in \mathbb{R}^d$ that:*

$$\max\{|g(x)|\} \leq \mathfrak{L} (1 + \|x\|_E^p) \tag{2.1.3}$$

and let $(\Omega, \mathcal{F}, \mathbb{P})$ be a probability space. Let $\mathcal{W}^\theta : [0, T] \times \Omega \rightarrow \mathbb{R}^d$, $\theta \in \Theta$ be independent standard Brownian motions, let $u \in C([0, T] \times \mathbb{R}^d, \mathbb{R})$ satisfy for all $t \in [0, T]$, $x \in \mathbb{R}^d$, that $\mathbb{E}[|g(x + \mathcal{W}_{T-t}^0)|] < \infty$ and:

$$u(t, x) = \mathbb{E} [g(x + \mathcal{W}_{T-t}^0)] \tag{2.1.4}$$

and let $U^\theta : [0, T] \times \mathbb{R}^d \times \Omega \rightarrow \mathbb{R}$, $\theta \in \Theta$ satisfy, $\theta \in \Theta$, $t \in [0, T]$, $x \in \mathbb{R}^d$, that:

$$U_m^\theta(t, x) = \frac{1}{m} \left[\sum_{k=1}^m g \left(x + \mathcal{W}_{T-t}^{(\theta, 0, -k)} \right) \right] \quad (2.1.5)$$

Lemma 2.1.7. *Assume Setting 2.1.6 then:*

- (i) it holds for all $n \in \mathbb{N}_0$, $\theta \in \Theta$ that $U^\theta : [0, T] \times \mathbb{R}^d \times \Omega \rightarrow \mathbb{R}$ is a continuous random field.
- (ii) it holds that for all $\theta \in \Theta$ that $\sigma(U^\theta) \subseteq \sigma\left(\left(\mathcal{W}^{(\theta, \nu)}\right)_{\nu \in \Theta}\right)$.
- (iii) it holds that $(U^\theta)_{\theta \in \Theta}, (\mathcal{W}^\theta)_{\theta \in \Theta}$, are independent.
- (iv) it holds for all $n, m \in \mathbb{N}$, $i, k, i, \mathfrak{k} \in \mathbb{Z}$, with $(i, k) \neq (i, \mathfrak{k})$ that $(U^{(\theta, i, k)})_{\theta \in \Theta}$ and $(U^{(\theta, i, \mathfrak{k})})_{\theta \in \Theta}$ are independent and,
- (v) it holds that $(U^\theta)_{\theta \in \Theta}$ are identically distributed random variables.

Proof. For (i) Consider that $\mathcal{W}_{T-t}^{(\theta, 0, -k)}$ are continuous random fields and that $g \in C(\mathbb{R}^d, \mathbb{R})$, we have that $U^\theta(t, x)$ is the composition of continuous functions with $m > 0$ by hypothesis, ensuring no singularities. Thus $U^\theta : [0, T] \times \mathbb{R}^d \times \Omega \rightarrow \mathbb{R}$.

For (ii) observe that for all $\theta \in \Theta$ it holds that \mathcal{W}^θ is $\mathcal{B}([0, T] \otimes \sigma(W^\theta)) / \mathcal{B}(\mathbb{R}^d)$ -measurable, this, and induction on prove item (ii).

Moreover observe that item (ii) and the fact that for all $\theta \in \Theta$ it holds that $(\mathcal{W}_{\vartheta \in \Theta}^{(\theta, \vartheta)})$, \mathcal{W}^θ are independently establish item (iii).

Furthermore, note that (ii) and the fact that for all $i, k, i, \mathfrak{k} \in \mathbb{Z}$, $\theta \in \Theta$, with $(i, k) \neq (i, \mathfrak{k})$ it holds that $(\mathcal{W}^{(\theta, i, k, \vartheta)})_{\vartheta \in \Theta}$ and $(\mathcal{W}^{(\theta, i, \mathfrak{k}, \vartheta)})_{\vartheta \in \Theta}$ are independent establish item (iv).

Huttenhaler ([Huttenhaler et al., 2020a](#), Corollary 2.5) establish item (v). This completes the proof of Lemma 1.1. \square

Lemma 2.1.8. *Assume Setting 2.1.6. Then it holds for $\theta \in \Theta$, $s \in [0, T]$, $t \in [s, T]$, $x \in \mathbb{R}^d$ that:*

$$\mathbb{E} \left[\left| U^\theta \left(t, x + \mathcal{W}_{t-s}^\theta \right) \right| \right] + \mathbb{E} \left[\left| g \left(x + \mathcal{W}_{t-s}^\theta \right) \right| \right] + \int_s^T \mathbb{E} \left[\left| U^\theta \left(r, x + \mathcal{W}_{r-s}^\theta \right) \right| \right] dr < \infty \quad (2.1.6)$$

Proof. Note that (2.1.3), the fact that for all $r, a, b \in [0, \infty)$ it holds that $(a+b)^r \leq 2^{\max\{r-1, 0\}}(a^r + b^r)$, and the fact that for all $\theta \in \Theta$ it holds that $\mathbb{E}[\|\mathcal{W}_T^\theta\|] < \infty$, assure that for all $s \in [0, T]$, $t \in [s, T]$, $\theta \in \Theta$ it holds that:

$$\begin{aligned} \mathbb{E} \left[\left| g(x + \mathcal{W}_{t-s}^\theta) \right| \right] &\leq \mathbb{E} \left[\mathfrak{L} \left(1 + \|x + \mathcal{W}_{t-s}^\theta\|_E^p \right) \right] \\ &\leq \mathfrak{L} \left[1 + 2^{\max\{p-1, 0\}} \left(\|x\|_E^p + \mathbb{E} \left[\|\mathcal{W}_T^\theta\|_E^p \right] \right) \right] < \infty \end{aligned} \quad (2.1.7)$$

We next claim that for all $s \in [0, T]$, $t \in [s, T]$, $\theta \in \Theta$ it holds that:

$$\mathbb{E} \left[\left| U^\theta \left(t, x + \mathcal{W}_{t-s}^\theta \right) \right| \right] + \int_s^T \mathbb{E} \left[\left| U^\theta \left(r, x + \mathcal{W}_{r-s}^\theta \right) \right| \right] dr < \infty \quad (2.1.8)$$

To prove this claim observe the triangle inequality and (2.1.5), demonstrate that for all $s \in [0, T]$, $t \in [s, T]$, $\theta \in \Theta$, it holds that:

$$\mathbb{E} \left[\left| U^\theta \left(t, x + \mathcal{W}_{t-s}^\theta \right) \right| \right] \leq \frac{1}{m} \left[\sum_{i=1}^m \mathbb{E} \left[\left| g \left(x + \mathcal{W}_{t-s}^\theta + \mathcal{W}_{T-t}^{(\theta, 0, -i)} \right) \right| \right] \right] \quad (2.1.9)$$

Now observe that (2.1.7) and the fact that $(W^\theta)_{\theta \in \Theta}$ are independent imply that for all $s \in [0, T]$, $t \in [s, T]$, $\theta \in \Theta$, $i \in \mathbb{Z}$ it holds that:

$$\mathbb{E} \left[\left| g \left(x + \mathcal{W}_{t-s}^\theta + \mathcal{W}_{T-t}^{(\theta, 0, i)} \right) \right| \right] = \mathbb{E} \left[\left| g \left(x + \mathcal{W}_{(t-s)+(T-t)}^\theta \right) \right| \right] = \mathbb{E} \left[\left| g \left(x + \mathcal{W}_{T-s}^\theta \right) \right| \right] < \infty \quad (2.1.10)$$

Combining (2.1.9) and (2.1.10) demonstrate that for all $s \in [0, T]$, $t \in [s, T]$, $\theta \in \Theta$ it holds that:

$$\mathbb{E} \left[\left| U^\theta(t, x + \mathcal{W}_{t-s}^\theta) \right| \right] < \infty \quad (2.1.11)$$

Finally observe that for all $s \in [0, T]$ $\theta \in \Theta$ it holds that:

$$\int_s^T \mathbb{E} \left[\left| U^\theta \left(r, x + \mathcal{W}_{r-s}^\theta \right) \right| \right] \leq (T-s) \sup_{r \in [s, T]} \mathbb{E} \left[\left| U^\theta \left(r, x + \mathcal{W}_{r-s}^\theta \right) \right| \right] < \infty \quad (2.1.12)$$

Combining (??), (2.1.11), and (2.1.12) completes the proof of Lemma 2.1.8.

□

Corollary 2.1.8.1. *Assume Setting 2.1.6, then we have:*

(i) *it holds that $t \in [0, T], x \in \mathbb{R}^d$ that:*

$$\mathbb{E} [|U^0(t, x)|] + \mathbb{E} \left[\left| g \left(x + \mathcal{W}_{T-t}^{(0,0,-1)} \right) \right| \right] < \infty \quad (2.1.13)$$

(ii) *it holds that $t \in [0, T], x \in \mathbb{R}^d$ that:*

$$\mathbb{E} [U^0(t, x)] = \mathbb{E} \left[g \left(x + \mathcal{W}_{T-t}^{(0,0,-1)} \right) \right] \quad (2.1.14)$$

Proof. (i) is a restatement of Lemma 2.1.8 in that for all $t \in [0, T]$:

$$\begin{aligned} & \mathbb{E} [|U^0(t, x)|] + \mathbb{E} \left[\left| g \left(x + \mathcal{W}_{T-t}^{(0,0,-1)} \right) \right| \right] \\ & < \mathbb{E} \left[\left| U^\theta \left(t, x + \mathcal{W}_{t-s}^\theta \right) \right| \right] + \mathbb{E} \left[\left| g \left(x + \mathcal{W}_{t-s}^\theta \right) \right| \right] + \int_s^T \mathbb{E} \left[\left| U^\theta \left(r, x + \mathcal{W}_{r-s}^\theta \right) \right| \right] dr \\ & < \infty \end{aligned} \quad (2.1.15)$$

Furthermore (ii) is a restatement of (4.0.7) with $\theta = 0$, $m = 1$, and $k = 1$. This completes the proof of Corollary 2.1.8.1. \square

2.2 Monte Carlo Approximations

Lemma 2.2.1. *Let $p \in (2, \infty), n \in \mathbb{N}$, let $(\Omega, \mathcal{F}, \mathbb{P})$, be a probability space and let $\mathcal{X}_i : \Omega \rightarrow \mathbb{R}$, $i \in \{1, 2, \dots, n\}$ be i.i.d. random variables with $\mathbb{E}[|\mathcal{X}_1|] < \infty$. Then it holds that:*

$$\left(\mathbb{E} \left[\left| \mathbb{E}[\mathcal{X}_1] - \frac{1}{n} \left(\sum_{i=1}^n \mathcal{X}_i \right) \right|^p \right] \right)^{\frac{1}{p}} \leq \left[\frac{p-1}{n} \right]^{\frac{1}{2}} (\mathbb{E} [|\mathcal{X}_1 - \mathbb{E}[\mathcal{X}_1]|^p])^{\frac{1}{p}} \quad (2.2.1)$$

Proof. The hypothesis that for all $i \in \{1, 2, \dots, n\}$ it holds that $\mathcal{X}_i : \Omega \rightarrow \mathbb{R}$ are i.i.d. random variables ensures that:

$$\mathbb{E} \left[\left| \mathbb{E}[\mathcal{X}_1] - \frac{1}{n} \left(\sum_{i=1}^n \mathcal{X}_i \right) \right|^p \right] = \mathbb{E} \left[\left| \frac{1}{n} \left(\sum_{i=1}^n (\mathbb{E}[\mathcal{X}_1] - \mathcal{X}_i) \right) \right|^p \right] = \frac{1}{n^p} \mathbb{E} \left[\left| \sum_{i=1}^n (\mathbb{E}[\mathcal{X}_1] - \mathcal{X}_i) \right|^p \right] \quad (2.2.2)$$

This combined with the fact that for all $i \in \{1, 2, \dots, n\}$ it is the case that $\mathcal{X}_i : \Omega \rightarrow \mathbb{R}$ are i.i.d. random variables and e.g. (Rio, 2009, Theorem 2.1) (with $p \curvearrowright p$, $(S_i)_{i \in \{0, 1, \dots, n\}} \curvearrowright (\sum_{k=1}^i (\mathbb{E}[X_k] - X_k))$, $(X_i)_{i \in \{1, 2, \dots, n\}} \curvearrowright (\mathbb{E}[X_i] - X_i)_{i \in \{1, 2, \dots, n\}}$ in the notation of (Rio, 2009, Theorem 2.1) ensures that:

$$\begin{aligned} \left(\mathbb{E} \left[\left| \mathbb{E}[\mathcal{X}_1] - \frac{1}{n} \left(\sum_{i=1}^n \mathcal{X}_i \right) \right|^p \right] \right)^{\frac{2}{p}} &= \frac{1}{n^2} \left(\mathbb{E} \left[\left| \sum_{i=1}^n (\mathbb{E}[\mathcal{X}_i] - \mathcal{X}_i) \right|^p \right] \right)^{\frac{2}{p}} \\ &\leq \frac{p-1}{n^2} \left[\sum_{i=1}^n (\mathbb{E} [|\mathbb{E}[\mathcal{X}_i] - \mathcal{X}_i|^p])^{\frac{2}{p}} \right] \\ &= \frac{p-1}{n^2} \left[n (\mathbb{E} [|\mathbb{E}[\mathcal{X}_1] - \mathcal{X}_1|^p])^{\frac{2}{p}} \right] \tag{2.2.3} \\ &= \frac{p-1}{n} (\mathbb{E} [|\mathbb{E}[\mathcal{X}_1] - \mathcal{X}_1|^p])^{\frac{2}{p}} \tag{2.2.4} \end{aligned}$$

This completes the proof of the lemma. \square

Corollary 2.2.1.1. *Let $p \in [2, \infty)$, $n \in \mathbb{N}$, let $(\Omega, \mathcal{F}, \mathbb{P})$ be a probability space, and let $\mathcal{X}_i : \Omega \rightarrow \mathbb{R}$, $i \in \{1, 2, \dots, n\}$ be i.i.d random variables with $\mathbb{E}[|\mathcal{X}_1|] < \infty$. Then it holds that:*

$$\left(\mathbb{E} \left[\left| \mathbb{E}[\mathcal{X}_1] - \frac{1}{n} \left(\sum_{i=1}^n \mathcal{X}_i \right) \right|^p \right] \right)^{\frac{1}{p}} \leq \left[\frac{p-1}{n} \right]^{\frac{1}{2}} (\mathbb{E} [|\mathcal{X}_1 - \mathbb{E}[\mathcal{X}_1]|^p])^{\frac{1}{p}} \tag{2.2.5}$$

Proof. Observe that e.g. (Grohs et al., 2018, Lemma 2.3) and Lemma 2.3.1 establish (2.2.5). \square

Corollary 2.2.1.2. *Let $p \in [2, \infty)$, $n \in \mathbb{N}$, let $(\Omega, \mathcal{F}, \mathbb{P})$, be a probability space, and let $\mathcal{X}_i : \Omega \rightarrow \mathbb{R}$, $i \in \{1, 2, \dots, n\}$, be i.i.d. random variables with $\mathbb{E}[|\mathcal{X}_1|] < \infty$, then:*

$$\left(\mathbb{E} \left[\left| \mathbb{E}[\mathcal{X}_1] - \frac{1}{n} \left(\sum_{i=1}^n \mathcal{X}_i \right) \right|^p \right] \right)^{\frac{1}{p}} \leq \frac{\mathfrak{t}_p \sqrt{p-1}}{n^{\frac{1}{2}}} (\mathbb{E} [|\mathcal{X}_1|^p])^{\frac{1}{p}} \tag{2.2.6}$$

Proof. This a direct consequence of Definition 2.1.5 and Corollary 2.2.1.1. \square

2.3 Bounds and Covnvergence

Lemma 2.3.1. *Assume Setting 4.0.1. Then it holds for all $t \in [0, T]$, $x \in \mathbb{R}^d$*

$$\begin{aligned} & \left(\mathbb{E} \left[\left| U^0(t, x + \mathcal{W}_t^0) - \mathbb{E} [U^0(t, x + \mathcal{W}_t^0)] \right|^{\mathfrak{p}} \right] \right)^{\frac{1}{\mathfrak{p}}} \\ & \leq \frac{\mathfrak{m}}{m^{\frac{1}{2}}} \left[\left(\mathbb{E} \left[|g(x + \mathcal{W}_T^0)|^{\mathfrak{p}} \right] \right)^{\frac{1}{\mathfrak{p}}} \right] \end{aligned} \quad (2.3.1)$$

Proof. For notational simplicity, let $G_k : [0, T] \times \mathbb{R}^d \times \Omega \rightarrow \mathbb{R}$, $k \in \mathbb{Z}$, satisfy for all $k \in \mathbb{Z}$, $t \in [0, T]$, $x \in \mathbb{R}^d$ that:

$$G_k(t, x) = g \left(x + \mathcal{W}_{T-t}^{(0,0,-k)} \right) \quad (2.3.2)$$

Observe that the hypothesis that $(\mathcal{W}^\theta)_{\theta \in \Theta}$ are independent Brownian motions and the hypothesis that $g \in C(\mathbb{R}^d, \mathbb{R})$ assure that for all $t \in [0, T]$, $x \in \mathbb{R}^d$ it holds that $(G_k(t, x))_{k \in \mathbb{Z}}$ are i.i.d. random variables. This and Corollary 2.2.1.2 (applied for every $t \in [0, T]$, $x \in \mathbb{R}^d$ with $p \curvearrowright \mathfrak{p}$, $n \curvearrowright m$, $(X_k)_{k \in \{1, 2, \dots, m\}} \curvearrowright (G_k(t, x))_{k \in \{1, 2, \dots, m\}}$), with the notation of Corollary 2.2.1.2 ensure that for all $t \in [0, T]$, $x \in \mathbb{R}^d$, it holds that:

$$\left(\mathbb{E} \left[\left| \frac{1}{m} \left[\sum_{k=1}^m G_k(t, x) \right] - \mathbb{E} [G_1(t, x)] \right|^{\mathfrak{p}} \right] \right)^{\frac{1}{\mathfrak{p}}} \leq \frac{\mathfrak{m}}{m^{\frac{1}{2}}} \left(\mathbb{E} [|G_1(t, x)|^{\mathfrak{p}}] \right)^{\frac{1}{\mathfrak{p}}} \quad (2.3.3)$$

Combining this, with (1.16), (1.17), and item (ii) of Corollary 2.1.8.1 yields that:

$$\begin{aligned} & \left(\mathbb{E} \left[\left| U^0(t, x) - \mathbb{E} [U^0(t, x)] \right|^{\mathfrak{p}} \right] \right)^{\frac{1}{\mathfrak{p}}} \\ & = \left(\mathbb{E} \left[\left| \frac{1}{m} \left[\sum_{k=1}^m G_k(t, x) \right] - \mathbb{E} [G_1(t, x)] \right|^{\mathfrak{p}} \right] \right)^{\frac{1}{\mathfrak{p}}} \end{aligned} \quad (2.3.4)$$

$$\leq \frac{\mathfrak{m}}{m^{\frac{1}{2}}} \left(\mathbb{E} [|G_1(t, x)|^{\mathfrak{p}}] \right)^{\frac{1}{\mathfrak{p}}} \quad (2.3.5)$$

$$= \frac{\mathfrak{m}}{m^{\frac{1}{2}}} \left[\left(\mathbb{E} \left[|g(x + \mathcal{W}_{T-t}^1)|^{\mathfrak{p}} \right] \right)^{\frac{1}{\mathfrak{p}}} \right] \quad (2.3.6)$$

This and the fact that \mathcal{W}^0 has independent increments ensure that for all $n \in \mathbb{Z}$, $t \in [0, T]$, $x \in \mathbb{R}^d$ it

holds that:

$$\left(\mathbb{E} \left[\left| U^0(t, x + \mathcal{W}_t^0) - \mathbb{E} [U^0(t, x + \mathcal{W}_t^0)] \right|^p \right] \right)^{\frac{1}{p}} \leq \frac{\mathbf{m}}{m^{\frac{1}{2}}} \left[\left(\mathbb{E} \left[|g(x + \mathcal{W}_T^0)|^p \right] \right)^{\frac{1}{p}} \right] \quad (2.3.7)$$

This completes the proof of Lemma 2.3.1. \square

Lemma 2.3.2. *Assume Setting 2.1.6. Then it holds for all, $t \in [0, T]$, $x \in \mathbb{R}^d$ that:*

$$\left(\mathbb{E} \left[\left| U^0(t, x + \mathcal{W}_t^0) - u(t, x + \mathcal{W}_t^0) \right|^p \right] \right)^{\frac{1}{p}} \leq \left(\frac{\mathbf{m}}{m^{\frac{1}{2}}} \right) \left(\mathbb{E} \left[|g(x + \mathcal{W}_T^0)|^p \right] \right)^{\frac{1}{p}} \quad (2.3.8)$$

Proof. Observe that from Corollary 2.1.8.1 item (ii) we have:

$$\mathbb{E} [U^0(t, x)] = \mathbb{E} \left[g \left(x + \mathcal{W}_{T-t}^{(0,0,-1)} \right) \right] \quad (2.3.9)$$

This and (4.0.6) ensure that:

$$\begin{aligned} u(t, x) - \mathbb{E} [U^0(t, x)] &= 0 \\ \mathbb{E} [U^0(t, x)] - u(t, x) &= 0 \end{aligned} \quad (2.3.10)$$

This, and the fact that \mathcal{W}^0 has independent increments, assure that for all, $t \in [0, T]$, $x \in \mathbb{R}^d$, it holds that:

$$\left(\mathbb{E} \left[\left| \mathbb{E} [U^0(t, x + \mathcal{W}_t^0)] - u(t, x + \mathcal{W}_t^0) \right|^p \right] \right)^{\frac{1}{p}} = 0 \leq \left(\mathbb{E} \left[|u(t, x + \mathcal{W}_t^0)|^p \right] \right)^{\frac{1}{p}} \quad (2.3.11)$$

This along with (4.0.6) ensure that:

$$\left(\mathbb{E} \left[\left| \mathbb{E} [U^0(t, x + \mathcal{W}_t^0)] - u(t, x + \mathcal{W}_t^0) \right|^p \right] \right)^{\frac{1}{p}} = 0 \leq \left(\mathbb{E} \left[|g(x + \mathcal{W}_T^0)|^p \right] \right)^{\frac{1}{p}} \quad (2.3.12)$$

Notice that the triangle inequality gives us:

$$\begin{aligned} \left(\mathbb{E} \left[|U^0(t, x + \mathcal{W}_t^0) - u(t, x + \mathcal{W}_t^0)|^p \right] \right)^{\frac{1}{p}} &\leq \left(\mathbb{E} \left[|U^0(t, x + \mathcal{W}_t^0) - \mathbb{E} [U^0(t, x + \mathcal{W}_t^0)]|^p \right] \right)^{\frac{1}{p}} \\ &\quad + \left(\mathbb{E} \left[|\mathbb{E} [U^0(t, x + \mathcal{W}_t^0)] - u(t, x + \mathcal{W}_t^0)|^p \right] \right)^{\frac{1}{p}} \end{aligned} \quad (2.3.13)$$

This, combined with (1.26), (1.21), the independence of Brownian motions, gives us:

$$\begin{aligned} \left(\mathbb{E} \left[|U^0(t, x + \mathcal{W}_t^0) - u(t, x + \mathcal{W}_t^0)|^p \right] \right)^{\frac{1}{p}} &\leq \left(\frac{\mathbf{m}}{m^{\frac{1}{2}}} \right) \left(\mathbb{E} \left[|g(x + \mathcal{W}_T^0)|^p \right] \right)^{\frac{1}{p}} \\ &= \left(\frac{\mathbf{m}}{m^{\frac{1}{2}}} \right) \left(\mathbb{E} \left[|g(x + \mathcal{W}_T^0)|^p \right] \right)^{\frac{1}{p}} \end{aligned} \quad (2.3.14)$$

This completes the proof of Lemma 2.3.2. \square

Lemma 2.3.3. *Assume Setting 2.1.6. Then it holds for all $t \in [0, T]$, $x \in \mathbb{R}^d$ that:*

$$\left(\mathbb{E} \left[|U^0(t, x + \mathcal{W}_t^0) - u(t, x + \mathcal{W}_t^0)|^p \right] \right)^{\frac{1}{p}} \leq \mathfrak{L} \left(\frac{\mathbf{m}}{m^{\frac{1}{2}}} \right) \left(\sup_{s \in [0, T]} \mathbb{E} \left[(1 + \|x + \mathcal{W}_s^0\|_E^p)^p \right] \right)^{\frac{1}{p}} \quad (2.3.15)$$

Proof. Observe that Lemma 2.3.2 ensures that:

$$\left(\mathbb{E} \left[|U^0(t, x + \mathcal{W}_t^0) - u(t, x + \mathcal{W}_t^0)|^p \right] \right)^{\frac{1}{p}} \leq \left(\frac{\mathbf{m}}{m^{\frac{1}{2}}} \right) \left(\mathbb{E} \left[|g(x + \mathcal{W}_T^0)|^p \right] \right)^{\frac{1}{p}} \quad (2.3.16)$$

Observe next that (4.0.6) ensures that:

$$\left(\frac{\mathbf{m}}{m^{\frac{1}{2}}} \right) \left(\mathbb{E} \left[|g(x + \mathcal{W}_T^0)|^p \right] \right)^{\frac{1}{p}} \leq \mathfrak{L} \left(\frac{\mathbf{m}}{m^{\frac{1}{2}}} \right) \left(\mathbb{E} \left[(1 + \|x + \mathcal{W}_T^0\|_E^p)^p \right] \right)^{\frac{1}{p}} \quad (2.3.17)$$

Which in turn yields that:

$$\mathfrak{L} \left(\frac{\mathbf{m}}{m^{\frac{1}{2}}} \right) \left(\mathbb{E} \left[(1 + \|x + \mathcal{W}_T^0\|_E^p)^p \right] \right)^{\frac{1}{p}} \leq \mathfrak{L} \left(\frac{\mathbf{m}}{m^{\frac{1}{2}}} \right) \left(\sup_{s \in [0, T]} \mathbb{E} \left[(1 + \|x + \mathcal{W}_s^0\|_E^p)^p \right] \right)^{\frac{1}{p}} \quad (2.3.18)$$

Combining 2.3.16, 2.3.17, and 2.3.18 yields that:

$$\begin{aligned} \left(\mathbb{E} \left[|U^0(t, x + \mathcal{W}_t^0) - u(t, x + \mathcal{W}_t^0)|^p \right] \right)^{\frac{1}{p}} &\leq \left(\frac{\mathbf{m}}{m^{\frac{1}{2}}} \right) \left(\mathbb{E} \left[|g(x + \mathcal{W}_T^0)|^p \right] \right)^{\frac{1}{p}} \\ &\leq \mathfrak{L} \left(\frac{\mathbf{m}}{m^{\frac{1}{2}}} \right) \left(\sup_{s \in [0, T]} \mathbb{E} \left[(1 + \|x + \mathcal{W}_s^0\|_E^p)^p \right] \right)^{\frac{1}{p}} \end{aligned} \quad (2.3.19)$$

This completes the proof of Lemma 2.3.3. \square

Corollary 2.3.3.1. *Assume Setting 2.1.6. Then it holds for all $t \in [0, T]$, $x \in \mathbb{R}^d$ that:*

$$\left(\mathbb{E} \left[|U^0(t, x) - u(t, x)|^p \right] \right)^{\frac{1}{p}} \leq \mathfrak{L} \left(\frac{\mathbf{m}}{m^{\frac{1}{2}}} \right) \left(\sup_{s \in [0, T]} \mathbb{E} \left[(1 + \|x + \mathcal{W}_s^0\|_E^p)^p \right] \right)^{\frac{1}{p}} \quad (2.3.20)$$

Proof. Observe that for all $t \in [0, T - \mathfrak{t}]$ and $\mathfrak{t} \in [0, T]$, and the fact that W^0 has independent increments it is the case that:

$$u(t + \mathfrak{t}, x) = \mathbb{E} \left[g \left(x + \mathcal{W}_{T-(t+\mathfrak{t})}^0 \right) \right] = \mathbb{E} \left[g \left(x + \mathcal{W}_{(T-\mathfrak{t})-t}^0 \right) \right] \quad (2.3.21)$$

It is also the case that:

$$U^\theta(t + \mathfrak{t}, x) = \frac{1}{m} \left[\sum_{k=1}^m g \left(x + \mathcal{W}_{T-(t+\mathfrak{t})}^{(\theta, 0, -k)} \right) \right] = \frac{1}{m} \left[\sum_{k=1}^m g \left(x + \mathcal{W}_{(T-\mathfrak{t})-t}^{(\theta, 0, -k)} \right) \right]$$

Then, applying Lemma 2.3.3, applied for all $\mathfrak{t} \in [0, T]$, with $\mathfrak{L} \curvearrowright \mathfrak{L}$, $p \curvearrowright p$, $\mathfrak{p} \curvearrowright \mathfrak{p}$, $T \curvearrowright (T - \mathfrak{t})$ is such that for all $\mathfrak{t} \in [0, T]$, $t \in [0, T - \mathfrak{t}]$, $x \in \mathbb{R}^d$ we have:

$$\begin{aligned} &\left(\mathbb{E} \left[|U^0(t + \mathfrak{t}, x + \mathcal{W}_t^0) - u(t + \mathfrak{t}, x + \mathcal{W}_t^0)|^p \right] \right)^{\frac{1}{p}} \\ &\leq \mathfrak{L} \left(\frac{\mathbf{m}}{m^{\frac{1}{2}}} \right) \left(\sup_{s \in [0, T-\mathfrak{t}]} \mathbb{E} \left[(1 + \|x + \mathcal{W}_s^0\|_E^p)^p \right] \right)^{\frac{1}{p}} \\ &\leq \mathfrak{L} \left(\frac{\mathbf{m}}{m^{\frac{1}{2}}} \right) \left(\sup_{s \in [0, T]} \mathbb{E} \left[(1 + \|x + \mathcal{W}_s^0\|_E^p)^p \right] \right)^{\frac{1}{p}} \end{aligned} \quad (2.3.22)$$

Thus we get for all $t \in [0, T]$, $x \in \mathbb{R}^d$, $n \in \mathbb{N}$:

$$\begin{aligned} \left(\mathbb{E} \left[\left| U^0(t, x) - u(t, x) \right|^p \right] \right)^{\frac{1}{p}} &= \left(\mathbb{E} \left[\left| U^0(t, x + \mathcal{W}_0^0) - u(t, x + \mathcal{W}_0^0) \right|^p \right] \right)^{\frac{1}{p}} \\ &\leq \mathfrak{L} \left(\frac{\mathfrak{m}}{m^{\frac{1}{2}}} \right) \left(\sup_{s \in [0, T]} \mathbb{E} \left[\left(1 + \|x + \mathcal{W}_s^0\|_E^p \right)^p \right] \right)^{\frac{1}{p}} \end{aligned} \quad (2.3.23)$$

This completes the proof of Corollary 2.3.3.1. \square

Theorem 2.3.4. *Let $T, L, p, q, \mathfrak{d} \in [0, \infty)$, $m \in \mathbb{N}$, $\Theta = \bigcup_{n \in \mathbb{N}} \mathbb{Z}^n$, let $g_d \in C(\mathbb{R}^d, \mathbb{R})$, and assume that $d \in \mathbb{N}$, $t \in [0, T]$, $x = (x_1, x_2, \dots, x_d) \in \mathbb{R}^d$, $v, w \in \mathbb{R}$ and that $\max\{|g_d(x)|\} \leq Ld^p (1 + \sum_{k=1}^d |x_k|)$, let $(\Omega, \mathcal{F}, \mathbb{P})$ be a probability space, let $\mathcal{W}^{d, \theta} : [0, T] \times \Omega \rightarrow \mathbb{R}^d$, $d \in \mathbb{N}$, $\theta \in \Theta$, be independent standard Brownian motions, assume for every $d \in \mathbb{N}$ that $(\mathcal{W}^{d, \theta})_{\theta \in \Theta}$ are independent, let $u_d \in C([0, T] \times \mathbb{R}^d, \mathbb{R})$, $d \in \mathbb{N}$, satisfy for all $d \in \mathbb{N}$, $t \in [0, T]$, $x \in \mathbb{R}^d$ that $\mathbb{E} \left[g_x \left(x + \mathcal{W}_{T-t}^{d, 0} \right) \right] < \infty$ and:*

$$u_d(t, x) = \mathbb{E} \left[g_d \left(x + \mathcal{W}_{T-t}^{d, 0} \right) \right] \quad (2.3.24)$$

Let $U_m^{d, \theta} : [0, T] \times \mathbb{R}^d \times \Omega \rightarrow \mathbb{R}$, $d \in \mathbb{N}$, $m \in \mathbb{Z}$, $\theta \in \Theta$, satisfy for all, $d \in \mathbb{N}$, $m \in \mathbb{Z}$, $\theta \in \Theta$, $t \in [0, T]$, $x \in \mathbb{R}^d$ that:

$$U_m^{d, \theta}(t, x) = \frac{1}{m} \left[\sum_{k=1}^m g_d \left(x + \mathcal{W}_{T-t}^{d, (\theta, 0, -k)} \right) \right] \quad (2.3.25)$$

and for every $d, n, m \in \mathbb{N}$ let $\mathfrak{C}_{d, n, m} \in \mathbb{Z}$ be the number of function evaluations of $u_d(0, \cdot)$ and the number of realizations of scalar random variables which are used to compute one realization of $U_m^{d, 0}(T, 0) : \Omega \rightarrow \mathbb{R}$.

There then exists $c \in \mathbb{R}$, and $\mathfrak{N} : \mathbb{N} \times (0, 1] \rightarrow \mathbb{N}$ such that for all $d \in \mathbb{N}$, $\varepsilon \in (0, 1]$ it holds that:

$$\sup_{t \in [0, T]} \sup_{x \in [-L, L]^d} \left(\mathbb{E} \left[\left| u_d(t, x) - U_{\mathfrak{N}(d, \varepsilon)}^{d, 0} \right|^p \right] \right)^{\frac{1}{p}} \leq \varepsilon \quad (2.3.26)$$

and:

$$\mathfrak{C}_{d, \mathfrak{N}(d, \varepsilon), \mathfrak{N}(d, \varepsilon)} \leq cd^c \varepsilon^{-(2+\delta)} \quad (2.3.27)$$

Proof. Throughout the proof let $\mathfrak{m}_p = \sqrt{p-1}$, $p \in [2, \infty)$, let $\mathbb{F}_t^d \subseteq \mathcal{F}$, $d \in \mathbb{N}$, $t \in [0, T]$ satisfy for all $d \in \mathbb{N}$, $t \in [0, T]$ that:

$$\mathbb{F}_t^d = \begin{cases} \bigcap_{s \in [t, T]} \sigma \left(\sigma \left(W_r^{d,0} : r \in [0, s] \right) \cup \{A \in \mathcal{F} : \mathbb{P}(A) = 0\} \right) & : t < T \\ \sigma \left(\sigma \left(W_s^{d,0} : s \in [0, T] \right) \cup \{A \in \mathcal{F} : \mathbb{P}(A) = 0\} \right) & : t = T \end{cases} \quad (2.3.28)$$

Observe that (2.3.28) guarantees that $\mathbb{F}_t^d \subseteq \mathcal{F}$, $d \in \mathbb{N}$, $t \in [0, T]$ satisfies that:

(I) it holds for all $d \in \mathbb{N}$ that $\{A \in \mathcal{F} : \mathbb{P}(A) = 0\} \subseteq \mathbb{F}_0^d$

(II) it holds for all $d \in \mathbb{N}$, $t \in [0, T]$, that $\mathbb{F}_t^d = \bigcap_{s \in (t, T]} \mathbb{F}_s^d$.

Combining item (I), item (II), (2.3.28) and (Hutzenthaler et al., 2020b, Lemma 2.17) assures us that for all $d \in \mathbb{N}$ it holds that $W^{d,0} : [0, T] \times \Omega \rightarrow \mathbb{R}^d$ is a standard $(\Omega, \mathcal{F}, \mathbb{P}, (\mathbb{F}_t^d)_{t \in [0, T]})$ -Brownian motion. In addition (58) ensures that it is the case that for all $d \in \mathbb{N}$, $x \in \mathbb{R}^d$ it holds that $[0, T] \times \Omega \ni (t, \omega) \mapsto x + W_t^{d,0}(\omega) \in \mathbb{R}^d$ is an $(\mathbb{F}_t^d)_{t \in [0, T]} / \mathcal{B}(\mathbb{R}^d)$ -adapted stochastic process with continuous sample paths.

This and the fact that for all $d \in \mathbb{N}$, $t \in [0, T]$, $x \in \mathbb{R}^d$ it holds that $a_d(t, x) = 0$, and the fact that for all $d \in \mathbb{N}$, $t \in [0, T]$, $x, v \in \mathbb{R}^d$ it holds that $b_d(t, x)v = v$ yield that for all $d \in \mathbb{N}$, $x \in \mathbb{R}^d$ it holds that $[0, T] \times \Omega \ni (t, \omega) \mapsto x + W_t^{d,0}(\omega) \in \mathbb{R}^d$ satisfies for all $t \in [0, T]$ it holds \mathbb{P} -a.s. that:

$$x + W_t^{d,0} = x + \int_0^t 0 ds + \int_0^t dW_s^{d,0} = x + \int_0^t a_d(s, x + W_s^{d,0}) ds + \int_0^t b_d(s, x + W_s^{d,0}) dW_s^{d,0} \quad (2.3.29)$$

This and (Hutzenthaler et al., 2020b, Lemma 2.6) (applied for every $d \in \mathbb{N}$, $x \in \mathbb{R}^d$ with $d \curvearrowright d$, $m \curvearrowright d$, $T \curvearrowright T$, $C_1 \curvearrowright d$, $C_2 \curvearrowright 0$, $\mathbb{F} \curvearrowright \mathbb{F}^d$, $\xi \curvearrowright x$, $\mu \curvearrowright a_d$, $\sigma \curvearrowright b_d$, $W \curvearrowright W^{d,0}$, $X \curvearrowright ([0, T] \times \Omega \ni (t, \omega) \mapsto x + W_t^{d,0}(\omega) \in \mathbb{R}^d)$ in the notation of (Hutzenthaler et al., 2020b, Lemma 2.6) ensures that for all $r \in [0, \infty)$, $d \in \mathbb{N}$, $x \in \mathbb{R}^d$, $t \in [0, T]$ it holds that

$$\mathbb{E} \left[\left\| x + W_t^{d,0} \right\|^r \right] \leq \max\{T, 1\} \left(\left(1 + \|x\|^2\right)^{\frac{r}{2}} + (r+1)d^{\frac{r}{2}} \right) \exp \left(\frac{r(r+3)T}{2} \right) < \infty \quad (2.3.30)$$

This, the triangle inequality, and the fact that for all $v, w \in [0, \infty)$, $r \in (0, 1]$, it holds that

$(v + w)^r \leq v^r + w^r$ assure that for all $\mathbf{p} \in [2, \infty)$, $d \in \mathbb{N}$, $x \in \mathbb{R}^d$ it holds that:

$$\begin{aligned}
& \sup_{s \in [0, T]} \left(\mathbb{E} \left[\left(1 + \left\| x + W_s^{d,0} \right\|_E^q \right)^{\mathbf{p}} \right] \right)^{\frac{1}{\mathbf{p}}} \leq 1 + \sup_{s \in [0, T]} \left(\mathbb{E} \left[\left\| x + W_s^{d,0} \right\|_E^{q\mathbf{p}} \right] \right)^{\frac{1}{\mathbf{p}}} \\
& \leq 1 + \sup_{s \in [0, T]} \left(\max\{T, 1\} \left(\left(1 + \|x\|_E^2 \right)^{\frac{q\mathbf{p}}{2}} + (q\mathbf{p} + 1)d^{\frac{q\mathbf{p}}{2}} \right) \exp \left(\frac{q\mathbf{p}(q\mathbf{p} + 3)T}{2} \right) \right)^{\frac{1}{\mathbf{p}}} \\
& \leq 1 + \max\{T^{\frac{1}{\mathbf{p}}}, 1\} \left(\left(1 + \|x\|_E^2 \right)^{\frac{q\mathbf{p}}{2}} + (q\mathbf{p} + 1)d^{\frac{q\mathbf{p}}{2}} \right) \exp \left(\frac{q(q\mathbf{p} + 3)T}{2} \right) \\
& \leq 2 \left(\left(1 + \|x\|_E^2 \right)^{\frac{q\mathbf{p}}{2}} + (q\mathbf{p} + 1)d^{\frac{q\mathbf{p}}{2}} \right) \exp \left(\frac{q(q\mathbf{p} + 3)T}{2} + \frac{T}{\mathbf{p}} \right) \\
& \leq 2 \left(\left(1 + \|x\|_E^2 \right)^{\frac{q\mathbf{p}}{2}} + (q\mathbf{p} + 1)d^{\frac{q\mathbf{p}}{2}} \right) \exp \left(\frac{[q(q\mathbf{p} + 3) + 1]T}{2} \right) \tag{2.3.31}
\end{aligned}$$

Given that for all $d \in \mathbb{N}$, $x \in [-L, L]^d$ it holds that $\|x\|_E \leq Ld^{\frac{1}{2}}$, this demonstrates for all $\mathbf{p} \in [2, \infty)$, $d \in \mathbb{N}$, it holds that:

$$\begin{aligned}
& L \left(\frac{\mathbf{m}_{\mathbf{p}}}{m^{\frac{1}{2}}} \right) \left(\sup_{x \in [-L, L]^d} \sup_{s \in [0, T]} \left(\mathbb{E} \left[\left(1 + \left\| x + W_s^{d,0} \right\|_E^q \right)^{\mathbf{p}} \right] \right)^{\frac{1}{\mathbf{p}}} \right) \\
& \leq L \left(\frac{\mathbf{m}_{\mathbf{p}}}{m^{\frac{1}{2}}} \right) \left(\sup_{x \in [-L, L]^d} \left[\left(\left(1 + \|x\|_E^2 \right)^{\frac{q\mathbf{p}}{2}} + (q\mathbf{p} + 1)d^{\frac{q\mathbf{p}}{2}} \right) \exp \left(\frac{[q(q\mathbf{p} + 3) + 1]T}{2} \right) \right] \right) \\
& \leq L \left(\frac{\mathbf{m}_{\mathbf{p}}}{m^{\frac{1}{2}}} \right) \left((1 + L^2d)^{\frac{q\mathbf{p}}{2}} + (q\mathbf{p} + 1)d^{\frac{q\mathbf{p}}{2}} \right) \exp \left(\frac{[q(q\mathbf{p} + 3) + 1]T}{2} \right) \tag{2.3.32}
\end{aligned}$$

Combining this with Corollary 2.3.3.1 tells us that:

$$\begin{aligned}
& \left(\mathbb{E} \left[\left| u_d(t, x) - U_m^{d,0}(t, x) \right|^{\mathbf{p}} \right] \right)^{\frac{1}{\mathbf{p}}} \\
& \leq L \left(\frac{\mathbf{m}_{\mathbf{p}}}{m^{\frac{1}{2}}} \right) \left(\sup_{x \in [-L, L]^d} \sup_{s \in [0, T]} \left(\mathbb{E} \left[\left(1 + \left\| x + W_s^{d,0} \right\|_E^q \right)^{\mathbf{p}} \right] \right)^{\frac{1}{\mathbf{p}}} \right) \\
& \leq L \left(\frac{\mathbf{m}_{\mathbf{p}}}{m^{\frac{1}{2}}} \right) \left((1 + L^2d)^{\frac{q\mathbf{p}}{2}} + (q\mathbf{p} + 1)d^{\frac{q\mathbf{p}}{2}} \right) \exp \left(\frac{[q(q\mathbf{p} + 3) + 1]T}{2} \right) \tag{2.3.33}
\end{aligned}$$

This and the fact that for all $d \in \mathbb{N}$ and $\varepsilon \in (0, \infty)$ and the fact that $\mathbf{m}_{\mathbf{p}} \leq 2$, it holds that for fixed L, q, \mathbf{p}, d, T there exists an $\mathfrak{M}_{L, q, \mathbf{p}, d, T} \in \mathbb{R}$ such that $\mathfrak{N}_{d, \varepsilon} \geq \mathfrak{M}_{L, q, \mathbf{p}, d, T}$ forces:

$$L \left[\frac{\mathbf{m}_{\mathbf{p}}}{\mathfrak{N}_{d, \varepsilon}^{\frac{1}{2}}} \right] \left((1 + L^2d)^{\frac{q\mathbf{p}}{2}} + (q\mathbf{p} + 1)d^{\frac{q\mathbf{p}}{2}} \right) \exp \left(\frac{[q(q\mathbf{p} + 3) + 1]T}{2} \right) \leq \varepsilon \tag{2.3.34}$$

Thus (2.3.33) and (2.3.34) together proves (2.3.26).

Note that $\mathfrak{C}_{d, \mathfrak{N}_{d, \epsilon}, \mathfrak{N}_{d, \epsilon}}$ is the number of function evaluations of $u_d(0, \cdot)$ and the number of realizations of scalar random variables which are used to compute one realization of $U_{\mathfrak{N}_{d, \epsilon}}^{d, 0}(T, 0) : \Omega \rightarrow \mathbb{R}$. Let $\widetilde{\mathfrak{N}_{d, \epsilon}}$ be the value of $\mathfrak{N}_{d, \epsilon}$ that causes equality in (2.3.34). In such a situation the number of evaluations of $u_d(0, \cdot)$ do not exceed $\widetilde{\mathfrak{N}_{d, \epsilon}}$. Each evaluation of $u_d(0, \cdot)$ requires at most one realization of scalar random variables. Thus we do not exceed $2\widetilde{\mathfrak{N}_{d, \epsilon}}$. Thus note that:

$$\mathfrak{C}_{d, \mathfrak{N}_{d, \epsilon}, \mathfrak{N}_{d, \epsilon}} \leq 2 \left[L \mathfrak{m}_{\mathfrak{p}} \left((1 + L^2 d)^{\frac{q\mathfrak{p}}{2}} + (q\mathfrak{p} + 1) d^{\frac{q\mathfrak{p}}{2}} \right) \exp \left(\frac{[q(q\mathfrak{p} + 3) + 1] T}{2} \right) \right] \varepsilon^{-1} \quad (2.3.35)$$

Note that other than d and ε everything on the right-hand side is constant or fixed. Hence (2.3.35) can be rendered as:

$$\mathfrak{C}_{d, \mathfrak{N}_{d, \epsilon}, \mathfrak{N}_{d, \epsilon}} \leq c d^k \varepsilon^{-1} \quad (2.3.36)$$

Where both c and k are dependent on $L, \mathfrak{p}, \mathfrak{m}, L$ □

Chapter 3

That u is a Viscosity Solution

We can extend the work for the heat equation to generic parabolic partial differential equations. We do this by first introducing viscosity solutions to Kolmogorov PDEs as given in Crandall & Lions [Crandall et al. \(1992\)](#) and further extended, esp. in [Beck et al. \(2021a\)](#).

3.1 Some Preliminaries

We take work previously pioneered by [Itô \(1942a\)](#) and [Itô \(1942b\)](#), and then seek to re-apply concepts first applied in [Beck et al. \(2021a\)](#) and [Beck et al. \(2021b\)](#).

Lemma 3.1.1. *Let $d, m \in \mathbb{N}$, $T \in (0, \infty)$. Let $\mu \in C^{1,2}([0, T] \times \mathbb{R}^d, \mathbb{R}^d)$ and $\sigma \in C^{1,2}([0, T] \times \mathbb{R}^d, \mathbb{R}^{d \times m})$ satisfying that they have non-empty compact supports and let $\mathfrak{S} = \text{supp}(\mu) \cup \text{supp}(\sigma) \subseteq [0, T] \times \mathbb{R}^d$. Let $(\Omega, \mathcal{F}, \mathbb{P}, (\mathbb{F}_t)_{t \in [0, T]})$ be a filtered probability space satisfying usual conditions. Let $W : [0, T] \times \Omega \rightarrow \mathbb{R}^m$ be a standard $(\mathbb{F}_t)_{t \in [0, T]}$ -Brownian motion, and let $\mathcal{X} : [0, T] \times \Omega \rightarrow \mathbb{R}^d$ be an $(\mathbb{F}_t)_{t \in [0, T]}$ -adapted stochastic process with continuous sample paths satisfying for all $t \in [0, T]$ with \mathbb{P} -a.s. that:*

$$\mathcal{X}_t = \mathcal{X}_0 + \int_0^t \mu(s, \mathcal{X}_s) ds + \int_0^t \sigma(s, \mathcal{X}_s) dW_s \quad (3.1.1)$$

It then holds that:

$$(i) \quad [(\mathbb{P}(\mathcal{X}_0 \notin \mathfrak{S}) = 1) \implies (\mathbb{P}(\forall t \in [0, T] : \mathcal{X}_t = \mathcal{X}_0) = 1)]$$

$$(ii) \quad [(\mathbb{P}(\mathcal{X}_0 \in \mathfrak{S}) = 1) \implies (\mathbb{P}(\forall t \in [0, T] : \mathcal{X}_t \in \mathfrak{S}) = 1)]$$

Proof. Assume that $\mathbb{P}(\mathcal{X}_0 \notin \mathfrak{S}) = 1$, meaning that the particle almost surely starts outside \mathfrak{S} . It is then the case that $\mathbb{P}(\forall t \in [0, T] : \|\mu(t, \mathcal{X}_0)\|_E + \|\sigma(t, \mathcal{X}_0)\|_F = 0) = 1$ as the μ and σ are outside their supports, and we integrate over zero over time.

It is then the case that:

$$\mathcal{Y} := \left([0, T] \times \Omega \ni (t, \omega) \mapsto \mathcal{X}_0(\omega) \in \mathbb{R}^d \right) \quad (3.1.2)$$

is an $(\mathbb{F}_t)_{t \in [0, T]}$ adapted stochastic process with continuous sample paths satisfying that for all $t \in [0, T]$ with \mathbb{P} -almost surety that:

$$\begin{aligned} \mathcal{Y}_t &= \mathcal{X}_0 + \int_0^t 0 ds + \int_0^t 0 dW_s = \mathcal{X}_0 + \int_0^t \mu(s, \mathcal{X}_0) ds + \int_0^t \sigma(s, \mathcal{X}_0) dW_s \\ &= \mathcal{X}_0 + \int_0^t \mu(s, \mathcal{Y}_s) ds + \int_0^t \sigma(s, \mathcal{Y}_s) dW_s \end{aligned} \quad (3.1.3)$$

Note that since $\mu \in C^{1,2}([0, T] \times \mathbb{R}^d, \mathbb{R}^d)$ and $\sigma \in C^{1,2}([0, T] \times \mathbb{R}^d, \mathbb{R}^{d \times m})$, and since continuous functions are locally Lipschitz, and since this is especially true in the space variable for μ and σ , the fact that \mathfrak{S} is compact and continuous functions over compact sets are Lipschitz and bounded, and (Karatzas and Shreve, 1991, Theorem 5.2.5) allows us to conclude that strong uniqueness holds, that is to say:

$$\mathbb{P}(\forall t \in [0, T] : \mathcal{X}_t = \mathcal{X}_0) = \mathbb{P}(\forall t \in [0, T] : \mathcal{X}_t = \mathcal{Y}_t) = 1 \quad (3.1.4)$$

establishing the case (i).

Assume now that $\mathbb{P}(\mathcal{X}_0 \in \mathfrak{S}) = 1$ that is to say that the particle almost surely starts inside \mathfrak{S} . We define $\tau : \Omega \rightarrow [0, T]$ as $\tau = \inf\{t \in [0, T] : \mathcal{X}_t \notin \overline{\mathfrak{S}}\}$. τ is an $(\mathbb{F}_t)_{t \in [0, T]}$ -adapted stopping time. On top of τ we can define $\mathcal{Y} : [0, T] \times \Omega \rightarrow \mathbb{R}^d$, for all $t \in [0, T]$, $\omega \in \Omega$ as $\mathcal{Y}_t(\omega) = \mathcal{X}_{\min\{t, \tau\}}(\omega)$. \mathcal{Y} is thus an $(\mathbb{F}_t)_{t \in [0, T]}$ -adapted stochastic process with continuous sample paths. Note however that for $t > \tau$ it is the case $\|\mu(t, \mathcal{Y}_t) + \sigma(t, \mathcal{Y}_t)\|_E = 0$ as we are outside their supports. For $t < \tau$ it is

also the case that $\mathcal{Y}_t = \mathcal{X}_t$. This yields with \mathbb{P} -a.s. that:

$$\begin{aligned}
\mathcal{Y}_t = \mathcal{X}_{\min\{t,\tau\}} &= \mathcal{X}_0 + \int_0^{\min\{t,\tau\}} \mu(s, \mathcal{X}_s) ds + \int_0^{\min\{t,\tau\}} \sigma(s, \mathcal{X}_s) dW_s \\
&= \mathcal{X}_0 + \int_0^t \mathbb{1}_{\{0 < s \leq \tau\}} \mu(s, \mathcal{X}_s) ds + \int_0^t \mathbb{1}_{\{0 < s \leq \tau\}} \sigma(s, \mathcal{X}_s) dW_s \\
&= \mathcal{X}_0 + \int_0^t \mu(s, \mathcal{Y}_s) ds + \int_0^t \sigma(s, \mathcal{Y}_s) dW_s
\end{aligned} \tag{3.1.5}$$

Thus another application of (Karatzas and Shreve, 1991, Theorem 5.2.5) and the fact that within our compact support \mathfrak{S} , the continuous functions μ and σ are Lipschitz and hence locally Lipschitz, and also bounded gives us:

$$\mathbb{P}(\forall t \in [0, T] : \mathcal{X}_t = \mathcal{Y}_t) = 1 \tag{3.1.6}$$

Proving case (ii). □

Lemma 3.1.2. *Let $d, m \in \mathbb{N}$, $T \in (0, \infty)$. Let $g \in C^2(\mathbb{R}^d, \mathbb{R})$. Let $\mu \in C^{1,3}([0, T] \times \mathbb{R}^d, \mathbb{R}^d)$ and $\sigma \in C^{1,3}([0, T] \times \mathbb{R}^d, \mathbb{R}^{d \times m})$ have non-empty compact supports and let $\mathfrak{S} = \text{supp}(\mu) \cup \text{supp}(\sigma)$. Let $(\Omega, \mathcal{F}, \mathbb{P}, (\mathbb{F}_t)_{t \in [0, T]})$ be a stochastic basis and let $W : [0, T] \times \Omega \rightarrow \mathbb{R}^m$ be a standard $(\mathbb{F}_t)_{t \in [0, T]}$ -Brownian motion. For every $t \in [0, T]$, $x \in \mathbb{R}^d$, let $\mathcal{X}^{t,x} = (\mathcal{X}_s^{t,x})_{s \in [t, T]} : [t, T] \times \Omega \rightarrow \mathbb{R}^d$ be an $(\mathbb{F}_s)_{s \in [t, T]}$ -adapted stochastic process with continuous sample paths satisfying for all $s \in [t, T]$ with \mathbb{P} -almost surety that:*

$$\mathcal{X}_s^{t,x} = x + \int_t^s \mu(r, \mathcal{X}_r^{t,x}) dr + \int_t^s \sigma(r, \mathcal{X}_r^{t,x}) dW_r \tag{3.1.7}$$

also let $u : \mathbb{R}^d \rightarrow \mathbb{R}$ satisfy for all $t \in [0, T]$, $x \in \mathbb{R}^d$ that:

$$u(t, x) = \mathbb{E} \left[g(\mathcal{X}_T^{t,x}) \right] \tag{3.1.8}$$

then it is the case that we have:

(i) $u \in C^{1,2}([0, T] \times \mathbb{R}^d, \mathbb{R})$ and

(ii) for all $t \in [0, T]$, $x \in \mathbb{R}^d$ that $u(T, x) = g(x)$ and:

$$\left(\frac{\partial}{\partial t} u\right)(t, x) + \frac{1}{2} \text{Trace}(\sigma(t, x) [\sigma(t, x)]^* (\text{Hess}_x u)(t, x)) + \langle \mu(t, x), (\nabla_x u)(t, x) \rangle = 0 \quad (3.1.9)$$

Proof. We break the proof down into two cases, inside the support $\mathfrak{S} = \text{supp}(\mu) \cup \text{supp}(\sigma)$ and outside the support: $[0, T] \times (\mathbb{R}^d \setminus \mathfrak{S})$.

For the case inside \mathfrak{S} . Note that we may deduce from Item (i) of Lemma 3.1.1 that for all $t \in [0, T]$, $x \in \mathbb{R}^d \setminus \mathfrak{S}$ it is the case that $\mathbb{P}(\forall s \in [t, T] : \mathcal{X}_s^{t,x} = x) = 1$. Thus for all $t \in [0, T]$, $x \in \mathbb{R}^d \setminus \mathfrak{S}$ we have, deriving from (3.1.8):

$$u(t, x) = \mathbb{E} \left[g \left(\mathcal{X}_T^{t,x} \right) \right] = g(x) \quad (3.1.10)$$

Note that $g(x)$ only has a space parameter and so derivatives w.r.t. t is 0. Inheriting from the regularity properties of g and (3.1.10), we may assume for all $t \in [0, T]$, $x \in \mathbb{R}^d \setminus \mathfrak{S}$, that $u|_{[0, T] \times (\mathbb{R}^d \setminus \mathfrak{S})} \in C^{1,2}([0, T] \times (\mathbb{R}^d \setminus \mathfrak{S}))$. Note that the hypotheses that $\mu \in C^{1,3}([0, T] \times \mathbb{R}^d, \mathbb{R}^d)$ and $\sigma \in C^{1,3}([0, T] \times \mathbb{R}^d, \mathbb{R}^{d \times m})$ allow us to apply Theorem 7.4.3, Theorem 7.4.5 and Theorem 7.5.1 from [Da Prato and Zabczyk \(2002\)](#) for $t \in [0, T]$, $x \in \mathbb{R}^d \setminus \mathfrak{S}$, to give us:

(i) $u \in C^{1,2}([0, T] \times \mathbb{R}^d, \mathbb{R})$.

(ii)

$$\begin{aligned} 0 &= \left(\frac{\partial}{\partial t} u\right)(t, x) \\ &= \left(\frac{\partial}{\partial t} u\right)(t, x) + \frac{1}{2} \text{Trace}(\sigma(t, x) [\sigma(t, x)]^* (\text{Hess}_x u)(t, x)) + \langle \mu(t, x), (\nabla_x u)(t, x) \rangle \end{aligned} \quad (3.1.11)$$

Now consider the case within support \mathfrak{S} . Note that by hypothesis μ and σ must at least be locally Lipschitz. Thus ([Karatzas and Shreve, 1991](#), Theorem 5.2.5) allows us to conclude that within \mathfrak{S} the pair (μ, σ) for our stochastic process $\mathcal{X}_s^{t,x}$ defined in (3.1.7) must exhibit a strong uniqueness property.

Further note that Item (ii) from Lemma 3.1.1 tells us that:

$$\mathbb{P}(\forall t \in [0, T] : \mathcal{X}_s^{t,x} \in \mathfrak{S}) = 1. \quad (3.1.12)$$

Note that again the hypotheses that $\mu \in C^{1,3}([0, T] \times \mathbb{R}^d, \mathbb{R}^d)$ and $\sigma \in C^{1,3}([0, T] \times \mathbb{R}^d, \mathbb{R}^{d \times m})$, and $g \in C^2(\mathbb{R}^d)$ allow us to apply Theorem 7.4.3, Theorem 7.4.5 and Theorem 7.5.1 from [Da Prato and Zabczyk \(2002\)](#) for $t \in [0, T]$, $x \in \mathfrak{S}$, to give us:

(i) $u \in C^{1,2}([0, T] \times \mathbb{R}^d, \mathbb{R})$.

(ii)

$$\left(\frac{\partial}{\partial t} u \right) (t, x) + \frac{1}{2} \text{Trace} (\sigma(t, x) [\sigma(t, x)]^* (\text{Hess}_x u) (t, x)) + \langle \mu(t, x), (\nabla_x u) (t, x) \rangle = 0 \quad (3.1.13)$$

Note that (3.1.7) and (3.1.8) together prove that $u(T, x) = g(x)$. This completes the proof. \square

3.2 Viscosity Solutions

Definition 3.2.1 (Symmetric Matrices). *Let $d \in \mathbb{N}$. The set of symmetric matrices is denoted \mathbb{S}_d given by $\mathbb{S}_d = \{A \in \mathbb{S}_d : A^* = A\}$.*

Definition 3.2.2 (Upper semi-continuity). *A function $f : U \rightarrow \mathbb{R}$ is upper semi-continuous at x_0 if for every $\varepsilon > 0$, there exists $\delta > 0$ such that:*

$$f(x) < f(x_0) + \varepsilon \text{ for all } x \in B(x_0, \delta) \cap U \quad (3.2.1)$$

Definition 3.2.3 (Lower semi-continuity). *A function $f : U \rightarrow \mathbb{R}$ is lower semi-continuous at x_0 if for every $\varepsilon > 0$, there exists $\delta > 0$ such that:*

$$f(x) > f(x_0) - \varepsilon \text{ for all } x \in B(x_0, \delta) \cap U \quad (3.2.2)$$

Corollary 3.2.3.1. *Given two upper semi-continuous functions $f, g : \mathbb{R}^d \rightarrow \mathbb{R}$, their sum $(f + g) : \mathbb{R}^d \rightarrow \mathbb{R}$ is also upper semi-continuous.*

Proof. From definitions, at any given $x_0 \in \mathbb{R}^d$, for any $\varepsilon \in (0, \infty)$ there exist neighborhoods U and V around x_0 such that:

$$(\forall x \in U) (f(x) \leq f(x_0) + \varepsilon) \quad (3.2.3)$$

$$(\forall x \in V) (g(x) \leq g(x_0) + \varepsilon) \quad (3.2.4)$$

and hence:

$$(\forall x \in U \cap V) (f(x) + g(x) \leq f(x_0) + g(x_0) + 2\varepsilon) \quad (3.2.5)$$

□

Corollary 3.2.3.2. *Given an upper semi-continuous function $f : \mathbb{R}^d \rightarrow \mathbb{R}$, it is the case that $(-f) : \mathbb{R}^d \rightarrow \mathbb{R}$ is lower semi-continuous.*

Proof. Let $f : \mathbb{R}^d \rightarrow \mathbb{R}$ be upper semi-continuous. At any given $x_0 \in \mathbb{R}^d$, for any $\varepsilon \in (0, \infty)$ there exists a neighborhood U around x_0 such that:

$$(\forall x \in U) (f(x) \leq f(x_0) + \varepsilon) \quad (3.2.6)$$

This also means that:

$$(\forall x \in U) (-f(x) \geq -f(x_0) - \varepsilon) \quad (3.2.7)$$

This completes the proof. □

Definition 3.2.4 (Degenerate Elliptic Functions). *Let $d \in \mathbb{N}$, $T \in (0, \infty)$, let $\mathcal{O} \subseteq \mathbb{R}^d$ be a non-empty open set, and let $\langle \cdot, \cdot \rangle : \mathbb{R}^d \times \mathbb{R}^d \rightarrow \mathbb{R}$ be the standard Euclidean inner product on \mathbb{R}^d . G is degenerate elliptic on $(0, T) \times \mathcal{O} \times \mathbb{R} \times \mathbb{R}^d \times \mathbb{S}_d$ if and only if:*

(i) $G : (0, T) \times \mathcal{O} \times \mathbb{R} \times \mathbb{R}^d \times \mathbb{S}_d \rightarrow \mathbb{R}$ is a function, and

(ii) for all $t \in (0, T)$, $x \in \mathcal{O}$, $r \in \mathbb{R}$, $p \in \mathbb{R}^d$, $A, B \in \mathbb{S}_d$, with $\forall y \in \mathbb{R}^d: \langle Ay, y \rangle \leq \langle By, y \rangle$ that

$$G(t, x, r, p, A) \leq G(t, x, r, p, B).$$

Remark 3.2.5. Let $t \in (0, T)$, $x \in \mathbb{R}^d$, $r \in \mathbb{R}$, $p \in \mathbb{R}^d$, $A \in \mathbb{S}_d$. Let $u \in C^{1,2}([0, T] \times \mathbb{R}^d, \mathbb{R})$, and let $\sigma : \mathbb{R}^d \rightarrow \mathbb{R}^{d \times d}$ and $\mu : \mathbb{R}^d \rightarrow \mathbb{R}^d$ be infinitely often differentiable. The function $G : (0, T) \times \mathbb{R}^d \times \mathbb{R} \times \mathbb{R}^d \times \mathbb{S}_d \rightarrow \mathbb{R}$ given by:

$$G(t, x, r, p, A) = \frac{1}{2} \text{Trace}(\sigma(x) [\sigma(x)]^* (\text{Hess}_x u)(t, x)) + \langle \mu(t, x), \nabla_x u(t, x) \rangle \quad (3.2.8)$$

where $(t, x, u(t, x), \mu(x), \sigma(x) [\sigma(x)]^*) \in (0, T) \times \mathbb{R}^d \times \mathbb{R} \times \mathbb{R}^d \times \mathbb{S}_d$, is degenerate elliptic.

Lemma 3.2.6. Given a function $G : (0, T) \times \mathcal{O} \times \mathbb{R} \times \mathbb{R}^d \times \mathbb{S}_d \rightarrow \mathbb{R}$ that is degenerate elliptic on $(0, T) \times \mathcal{O} \times \mathbb{R} \times \mathbb{R}^d \times \mathbb{S}_d$ it is also the case that $H : (0, T) \times \mathcal{O} \times \mathbb{R} \times \mathbb{R}^d \times \mathbb{S}_d \rightarrow \mathbb{R}$ given by $H(t, x, r, p, A) = -G(t, x, -r, -p, -A)$ is degenerate elliptic on $(0, T) \times \mathcal{O} \times \mathbb{R} \times \mathbb{R}^d \times \mathbb{S}_d$.

Proof. Note that H is a function. Assume for $y \in \mathbb{R}^d$ it is the case that $\langle Ay, y \rangle \leq \langle By, y \rangle$ then it is also the case by (??) that $\langle -Ay, y \rangle \geq \langle -By, y \rangle$ for $y \in \mathbb{R}^d$. However since G is monotonically increasing over the subset of $(0, T) \times \mathcal{O} \times \mathbb{R} \times \mathbb{R}^d \times \mathbb{S}_d$ where $\langle Ay, y \rangle \leq \langle By, y \rangle$ then it is also the case that $H(t, x, r, p, A) = -G(t, x, -r, -p, -A) \geq -G(t, x, -r, -p, -B) = H(t, x, r, p, B)$.

□

Definition 3.2.7 (Viscosity subsolutions). Let $d \in \mathbb{N}$, $T \in (0, \infty)$, let $\mathcal{O} \subseteq \mathbb{R}^d$ be a non-empty open set, and let $G : (0, T) \times \mathcal{O} \times \mathbb{R} \times \mathbb{R}^d \times \mathbb{S}_d \rightarrow \mathbb{R}$ be degenerate elliptic. Then we say that u is a viscosity solution of $(\frac{\partial}{\partial t} u)(t, x) + G(t, x, u(t, x), (\nabla_x u)(t, x), (\text{Hess}_x u)(t, x)) \geq 0$ for $(t, x) \in (0, T) \times \mathcal{O}$ if and only if there exists a set A such that:

(i) we have that $(0, T) \times \mathcal{O} \subseteq A$.

(ii) we have that $u : A \rightarrow \mathbb{R}$ is an upper semi-continuous function from A to \mathbb{R} , and

(iii) we have that for all $t \in (0, T)$, $x \in \mathcal{O}$, $\phi \in C^{1,2}((0, T) \times \mathcal{O}, \mathbb{R})$ with $\phi(t, x) = u(t, x)$ and $\phi \geq u$ that:

$$\left(\frac{\partial}{\partial t} u_d \right) (t, x) + G(t, x, \phi(t, x), (\nabla_x \phi)(t, x), (\text{Hess}_x \phi)(t, x)) \geq 0 \quad (3.2.9)$$

Definition 3.2.8 (Viscosity supersolutions). Let $d \in \mathbb{N}$, $T \in (0, \infty)$, let $\mathcal{O} \subseteq \mathbb{R}^d$ be a non-empty open set, and let $G : (0, T) \times \mathcal{O} \times \mathbb{R} \times \mathbb{R}^d \times \mathbb{S}_d \rightarrow \mathbb{R}$ be degenerate elliptic. Then we say that u is a viscosity solution of $(\frac{\partial}{\partial t} u)(t, x) + G(t, x, u(t, x), (\nabla_x u)(t, x), (\text{Hess}_x u)(t, x)) \leq 0$ for $(t, x) \in (0, T) \times \mathcal{O}$ if and only if there exists a set A such that:

(i) we have that $(0, T) \times \mathcal{O} \subseteq A$.

(ii) we have that $u : A \rightarrow \mathbb{R}$ is an upper semi-continuous function from A to \mathbb{R} , and

(iii) we have that for all $t \in (0, T)$, $x \in \mathcal{O}$, $\phi \in C^{1,2}((0, T) \times \mathcal{O}, \mathbb{R})$ with $\phi(t, x) = u(t, x)$ and $\phi \leq u$ that:

$$\left(\frac{\partial}{\partial t} u_d \right) (t, x) + G(t, x, \phi(t, x), (\nabla_x \phi)(t, x), (\text{Hess}_x \phi)(t, x)) \leq 0 \quad (3.2.10)$$

Definition 3.2.9 (Viscosity solution). Let $d \in \mathbb{N}$, $T \in (0, \infty)$, $\mathcal{O} \subseteq \mathbb{R}^d$ be a non-empty open set and let $G : (0, T) \times \mathcal{O} \times \mathbb{R} \times \mathbb{R}^d \times \mathbb{S}_d \rightarrow \mathbb{R}$ be degenerate elliptic. Then we say that u_d is a viscosity solution to $(\frac{\partial}{\partial t} u_d)(t, x) + G(t, x, u(t, x), \nabla_x(x, t), (\text{Hess}_x u_d)(t, x)) = 0$ if and only if:

(i) u is a viscosity subsolution of $(\frac{\partial}{\partial t} u_d)(t, x) + G(t, x, u(t, x), \nabla_x(x, t), (\text{Hess}_x u_d)(t, x)) = 0$ for $(t, x) \in (0, T) \times \mathcal{O}$

(ii) u is a viscosity supersolution of $(\frac{\partial}{\partial t} u_d)(t, x) + G(t, x, u(t, x), \nabla_x(x, t), (\text{Hess}_x u_d)(t, x)) = 0$ for $(t, x) \in (0, T) \times \mathcal{O}$

Lemma 3.2.10. Let $d \in \mathbb{N}$, $T \in (0, \infty)$, $\mathfrak{t} \in (0, T)$, let $\mathcal{O} \subseteq \mathbb{R}^d$ be an open set, let $\mathfrak{r} \in \mathcal{O}$, $\phi \in C^{1,2}((0, T) \times \mathcal{O}, \mathbb{R})$, let $G : (0, T) \times \mathcal{O} \times \mathbb{R} \times \mathbb{R}^d \times \mathbb{S}_d \rightarrow \mathbb{R}$ be degenerate elliptic and let $u_d : (0, T) \times \mathcal{O} \rightarrow \mathbb{R}$ be a viscosity solution of $(\frac{\partial}{\partial t} u_d)(t, x) + G(t, x, u(t, x), (\nabla_x u_D)(t, x), (\text{Hess}_x u_d)(t, x)) \geq 0$ for $(t, x) \in (0, T) \times \mathcal{O}$, and assume that $u - \phi$ has a local maximum at $(\mathfrak{t}, \mathfrak{r}) \in (0, T) \times \mathcal{O}$, then:

$$\left(\frac{\partial}{\partial t} \phi \right) (\mathfrak{t}, \mathfrak{r}) + G(\mathfrak{t}, \mathfrak{r}, u(\mathfrak{t}, \mathfrak{r}), (\nabla_x \phi)(\mathfrak{t}, \mathfrak{r}), (\text{Hess}_x \phi)(\mathfrak{t}, \mathfrak{r})) \geq 0 \quad (3.2.11)$$

Proof. That u is upper semi-continuous ensures that there exists as a neighborhood U around $(\mathfrak{t}, \mathfrak{r})$ and $\psi \in C^{1,2}((0, T) \times \mathcal{O}, \mathbb{R})$ where:

(i) for all $(t, x) \in (0, T) \times \mathcal{O}$ that $u(\mathfrak{t}, \mathfrak{r}) - \psi(\mathfrak{t}, \mathfrak{r}) \geq u(t, x) - \psi(t, x)$

(ii) for all $(t, x) \in U$ that $\phi(t, x) = \phi(t, x)$.

We therefore obtain that:

$$\begin{aligned} & \left(\frac{\partial}{\partial t} \phi \right) (\mathbf{t}, \mathbf{r}) + G(\mathbf{t}, \mathbf{r}, u(\mathbf{t}, \mathbf{r}), (\nabla_x)(\mathbf{t}, \mathbf{r}), (\text{Hess}_x \phi)(\mathbf{t}, \mathbf{r})) \\ &= \left(\frac{\partial}{\partial t} \psi \right) (\mathbf{t}, \mathbf{r}) + G(\mathbf{t}, \mathbf{r}, u(\mathbf{t}, \mathbf{r}), (\nabla_x)(\mathbf{t}, \mathbf{r}), (\text{Hess}_x \psi)(\mathbf{t}, \mathbf{r})) \geq 0 \end{aligned} \quad (3.2.12)$$

□

Lemma 3.2.11. *Let $d \in \mathbb{N}$, $T \in (0, \infty)$, let $\mathcal{O} \subseteq \mathbb{R}^d$ be a non-empty open set, let $u_n : (0, T) \times \mathcal{O} \rightarrow \mathbb{R}$, $n \in \mathbb{N}_0$ be functions, let $G_n : (0, T) \times \mathcal{O} \times \mathbb{R} \times \mathbb{R}^d \times \mathbb{S}_d \rightarrow \mathbb{R}$, $n \in \mathbb{N}$ be degenerate elliptic, assume that G_∞ is upper semi-continuous for all non-empty compact $\mathcal{K} \subseteq (0, T) \times \mathcal{O} \times \mathbb{R} \times \mathbb{R}^d \times \mathbb{S}_d$ that:*

$$\limsup_{n \rightarrow \infty} \left[\sup_{(t, x, r, p, A) \in \mathcal{K}} (|u_n(t, x) - u_0(t, x)| + |G_n(t, x, r, p, A) - G_0(t, x, r, p, A)|) \right] = 0 \quad (3.2.13)$$

and assume for all $n \in \mathbb{N}$ that u_n is a viscosity solution of:

$$\left(\frac{\partial}{\partial t} u_n \right) (t, x) + G_n(t, x, u_n(t, x), (\nabla_x u_n)(t, x), (\text{Hess}_x u_n)(t, x)) \geq 0 \quad (3.2.14)$$

then u_0 is a viscosity solution of:

$$\left(\frac{\partial}{\partial t} u_0 \right) (t, x) + G_n(t, x, u_0(t, x), (\nabla_x u_0)(t, x), (\text{Hess}_x u_0)(t, x)) \geq 0 \quad (3.2.15)$$

Proof. Let $(t_o, x_o) \in (0, T) \times \mathcal{O}$. Let $\phi_\epsilon \in C^{1,2}((0, T) \times \mathcal{O}, \mathbb{R})$ satisfy for all $\epsilon \in (0, \infty)$, $s \in (0, T)$, $y \in \mathcal{O}$ that $\phi_0(t_o, x_o) = u_0(t_o, x_o)$, $\phi_0(t_o, x_o) \geq u_0(t_o, x_o)$, and:

$$\phi_\epsilon(s, y) = \phi_o(s, y) + \epsilon(|s - t_o| + \|y - x_o\|_E) \quad (3.2.16)$$

Let $\delta \in (0, \infty)$ be such that $\{(s, y) \in \mathbb{R}^d \times \mathbb{R} : \max(|s - t_o|^2, \|y - x_o\|_E^2) \leq \delta\}$. Note that this and (3.2.27) then imply for all $\epsilon \in (0, \infty)$ there exists an $\nu_\epsilon \in \mathbb{N}$ such that for all $n \geq \nu_\epsilon$, and

$\max(|s - t_0|, \|y - x_0\|_E) \leq \delta$, it is the case that:

$$\sup(|u_n(s, y) - u_0(s, y)|) \leq \frac{\varepsilon\delta}{2} \quad (3.2.17)$$

Note that this combined with (3.2.16) tells us that for all $\varepsilon \in (0, \infty)$, $n \in \mathbb{N} \cap [\nu_\varepsilon, \infty)$, $s \in (0, T)$, $y \in \mathcal{O}$, with $|s - t_0| < \delta$, $\|y - x_0\|_E \leq \delta$, $|s - t_0| + \|y - x_0\|_E > \delta$ that:

$$\begin{aligned} u_n(t_0, x_0) - \phi_\varepsilon(t_0, x_0) &= u_n(t_0, x_0) - \phi_0(t_0, x_0) & (3.2.18) \\ &= u_n(t_0, x_0) - u_0(t_0, x_0) \\ &\geq \frac{-\varepsilon\delta}{2} \\ &\geq u_n(s, y) - u_0(s, y) - \varepsilon(|s - t_0| + \|y - x_0\|_E) \\ &\geq u_n(s, y) - \phi_0(s, y) - \varepsilon(|s - t_0| + \|y - x_0\|_E) \\ &= u_n(s, y) - \phi_\varepsilon(s, y) & (3.2.19) \end{aligned}$$

Note that Corollary 3.2.3.1 implies that for all $\varepsilon \in (0, \infty)$ and $n \in \mathbb{N}$ that $u_n - \phi_\varepsilon$ is upper semi-continuous. There therefore exists for all $\varepsilon \in (0, \infty)$ and $n \in \mathbb{N}$, a $\tau_n^\varepsilon \in (t_0 - \delta, t_0 + \delta)$ and a ρ_n^ε , where $\|\rho_n^\varepsilon - x_0\| \leq \delta$ such that:

$$u_n(\tau_n^\varepsilon, \rho_n^\varepsilon) - \phi_\varepsilon(\tau_n^\varepsilon, \rho_n^\varepsilon) \geq u_n(s, y) - \phi_\varepsilon(s, y) \quad (3.2.20)$$

By Lemma 3.2.10, it must be the case that for all $\varepsilon \in (0, \infty)$ and $n \in \mathbb{N} \cap [\nu_\varepsilon, \infty)$:

$$\left(\frac{\partial}{\partial t} \phi_\varepsilon\right)(\tau_n^\varepsilon, \rho_n^\varepsilon) + G_n(\tau_n^\varepsilon, \rho_n^\varepsilon, u_n(\tau_n^\varepsilon, \rho_n^\varepsilon), (\nabla_x \phi_\varepsilon)(\tau_n^\varepsilon, \rho_n^\varepsilon), (\text{Hess}_x \phi_\varepsilon)(\tau_n^\varepsilon, \rho_n^\varepsilon)) \geq 0 \quad (3.2.21)$$

Note however that (3.2.20) along with (3.2.16) and (3.2.27) yields that for all $\varepsilon \in (0, \infty)$ that:

$$\begin{aligned}
& \limsup_{n \rightarrow \infty} [u_n(\tau_n^\varepsilon, \rho_n^\varepsilon) - \phi_\varepsilon(\tau_n^\varepsilon, \rho_n^\varepsilon)] \\
& \geq \limsup_{n \rightarrow \infty} [u_n(\tau_n^\varepsilon, \rho_n^\varepsilon) - (\phi_0(\tau_n^\varepsilon, \rho_n^\varepsilon) + \varepsilon (|\tau_n^\varepsilon - t_0| + \|\rho_n^\varepsilon - x_0\|_E))] \\
& \geq \limsup_{n \rightarrow \infty} [u_n(\tau_n^\varepsilon, \rho_n^\varepsilon) - u_0(\tau_n^\varepsilon, \rho_n^\varepsilon) - \varepsilon (|\tau_n^\varepsilon - t_0| + \|\rho_n^\varepsilon - x_0\|_E)] \\
& = \limsup_{n \rightarrow \infty} [-\varepsilon (|\tau_n^\varepsilon - t_0| + \|\rho_n^\varepsilon - x_0\|_E)] \leq 0
\end{aligned} \tag{3.2.22}$$

However note also that since G_0 is upper semi-continuous, further the fact that, $\phi_0 \in ((0, T) \times \mathcal{O}, \mathbb{R})$,

and then (3.2.27), and (3.2.16), imply for all $\varepsilon \in (0, \infty)$ we have that: $\limsup_{n \rightarrow \infty} |(\frac{\partial}{\partial t} \phi_\varepsilon)(\tau_n^\varepsilon, \rho_n^\varepsilon) - (\frac{\partial}{\partial t} \phi_0)(t_0, x_0)|$

0 and:

$$\begin{aligned}
& G_0(t_0, x_0, \phi_0(t_0, x_0), (\nabla_x \phi_0)(t_0, x_0), (\text{Hess}_x \phi_0)(t_0, x_0) + \text{Id}_{\mathbb{R}^d}) \\
& = G_0(t_0, x_0, u_0(t_0, x_0), (\nabla_x \phi_\varepsilon)(t_0, x_0), (\text{Hess}_x \phi_\varepsilon)(t_0, x_0)) \\
& \geq \limsup_{n \rightarrow \infty} [G_0(\tau_n^\varepsilon, \rho_n^\varepsilon, u_n(\tau_n^\varepsilon, \rho_n^\varepsilon), (\nabla_x \phi_\varepsilon)(\tau_n^\varepsilon, \rho_n^\varepsilon), (\text{Hess}_x \phi_\varepsilon)(\tau_n^\varepsilon, \rho_n^\varepsilon))]
\end{aligned} \tag{3.2.23}$$

$$\geq \limsup_{n \rightarrow \infty} [G_n(\tau_n^\varepsilon, \rho_n^\varepsilon, u_n(\tau_n^\varepsilon, \rho_n^\varepsilon), (\nabla_x \phi_\varepsilon)(\tau_n^\varepsilon, \rho_n^\varepsilon), (\text{Hess}_x \phi_\varepsilon)(\tau_n^\varepsilon, \rho_n^\varepsilon))] \tag{3.2.24}$$

This with (3.2.20) assures for all $\varepsilon \in (0, \infty)$ that:

$$\left(\frac{\partial}{\partial t} \phi_0 \right) (t_0, x_0) + G_0(t_0, x_0, \phi_0(t_0, x_0), (\nabla_x \phi_0)(t_0, x_0), (\text{Hess}_x \phi_0)(t_0, x_0) + \varepsilon \text{Id}_{\mathbb{R}^d}) \geq 0 \tag{3.2.25}$$

That G_0 is upper semi-continuous then yields that:

$$\left(\frac{\partial}{\partial t} \phi_0 \right) (t_0, x_0) + G_0(t_0, x_0, \phi_0(t_0, x_0), (\nabla_x \phi_0)(t_0, x_0), (\text{Hess}_x \phi_0)(t_0, x_0) + \varepsilon \text{Id}_{\mathbb{R}^d}) \geq 0 \tag{3.2.26}$$

This establishes (3.2.29) which establishes the lemma. □

Corollary 3.2.11.1. *Let $d \in \mathbb{N}$, $T \in (0, \infty)$, let $\mathcal{O} \subseteq \mathbb{R}^d$ be a non-empty open set, let $u_n : (0, T) \times \mathcal{O} \rightarrow \mathbb{R}$, $n \in \mathbb{N}_0$ be functions, let $G_n : (0, T) \times \mathcal{O} \times \mathbb{R} \times \mathbb{R}^d \times \mathbb{S}_d \rightarrow \mathbb{R}$, $n \in \mathbb{N}_0$ be degenerate elliptic,*

assume that G_0 is lower semi-continuous for all non-empty compact $\mathcal{K} \subseteq (0, T) \times \mathcal{O} \times \mathbb{R} \times \mathbb{R}^d \times \mathbb{S}_d$ that:

$$\limsup_{n \rightarrow \infty} \left[\sup_{(t,x,r,p,A) \in \mathcal{K}} (|u_n(t,x) - u_0(t,x)| + |G_n(t,x,r,p,A) - G_0(t,x,r,p,A)|) \right] = 0 \quad (3.2.27)$$

and assume for all $n \in \mathbb{N}$ that u_n is a viscosity solution of:

$$\left(\frac{\partial}{\partial t} u_n \right) (t, x) + G_n(t, x, u_n(t, x), (\nabla_x u_n)(t, x), (\text{Hess}_x u_n)(t, x)) \leq 0 \quad (3.2.28)$$

then u_0 is a viscosity solution of:

$$\left(\frac{\partial}{\partial t} u_0 \right) (t, x) + G_n(t, x, u_0(t, x), (\nabla_x u_0)(t, x), (\text{Hess}_x u_0)(t, x)) \leq 0 \quad (3.2.29)$$

Proof. Let $v_n : (0, T) \times \mathcal{O} \rightarrow \mathbb{R}$, $n \in \mathbb{N}_0$ and $H_n : (0, T) \times \mathcal{O} \times \mathbb{R} \times \mathbb{R}^d \times \mathbb{S}_d \rightarrow \mathbb{R}$ satisfy for all $n \in \mathbb{N}_0$, $t \in (0, T)$, $x \in \mathcal{O}$, $r \in \mathbb{R}$, $p \in \mathbb{R}^d$, $A \in \mathbb{S}_d$ that $v_n(t, x) = -u_n(t, x)$ and that $H_n(t, x) = -G_n(t, x, -r, -p, -A)$.

Note that Corollary 3.2.3.2 gives us that H_0 is upper semi-continuous. Note also that since it is the case that for all $n \in \mathbb{N}_0$, G_n is degenerate elliptic then it is also the case by Lemma 3.2.6 that H_n is degenerate elliptic for all $n \in \mathbb{N}_0$. These together with (3.2.28) ensure that for all $n \in \mathbb{N}$, v_n is a viscosity solution of:

$$\left(\frac{\partial}{\partial t} v_n \right) (t, x) + H_n(t, x, v_n(t, x), (\nabla_x v_n)(t, x), (\text{Hess}_x v_n)(t, x)) \geq 0 \quad (3.2.30)$$

This together with (3.2.27) establish that:

$$\limsup_{n \rightarrow \infty} \left[\sup_{(t,x,r,p,A) \in \mathcal{K}} (|u_n(t,x) - u_0(t,x)| + |H_n(t,x,r,p,A) - H_0(t,x,r,p,A)|) \right] = 0 \quad (3.2.31)$$

This (3.2.30) and the fact that H_0 is upper semi-continuous then establish that:

$$\left(\frac{\partial}{\partial t} v_0 \right) (t, x) + H_0(t, x, v_0(t, x), (\nabla_x v_0)(t, x), (\text{Hess}_x v_0)(t, x)) \geq 0 \quad (3.2.32)$$

for $(t, x) \in (0, T) \times \mathcal{O}$. Hence v_0 is a viscosity solution of:

$$\left(\frac{\partial}{\partial t}u_0\right)(t, x) + H_0(t, x, u_0(t, x), (\nabla_x u_0)(t, x), (\text{Hess}_x u_0)(t, x)) \leq 0 \quad (3.2.33)$$

This completes the proof. \square

Corollary 3.2.11.2. *Let $d \in \mathbb{N}$, $T \in (0, \infty)$, let $\mathcal{O} \subseteq \mathbb{R}^d$ be a non-empty set, let $u_n : (0, T) \times \mathcal{O} \rightarrow \mathbb{R}$, $n \in \mathbb{N}_0$, be functions, let $G_n : (0, T) \times \mathcal{O} \times \mathbb{R} \times \mathbb{R}^d \times \mathbb{S}_d \rightarrow \mathbb{R}$, $n \in \mathbb{N}_0$ be degenerate elliptic, assume also that $G_0 : (0, T) \times \mathcal{O} \times \mathbb{R} \times \mathbb{R}^d \times \mathbb{S}_d \rightarrow \mathbb{R}$ be continuous and assume for all non-empty compact $\mathcal{K} \subseteq (0, T) \times \mathcal{O} \times \mathbb{R} \times \mathbb{R}^d \times \mathbb{S}_d$ it is the case that:*

$$\limsup_{n \rightarrow \infty} \left[\sup_{(t, x, r, p, A) \in \mathcal{K}} (|G_n(t, x, r, p, A) - G_0(t, x, r, p, A)| + |u_n(t, x) - u_0(t, x)|) \right] = 0 \quad (3.2.34)$$

and further assume for all $n \in \mathbb{N}$, that u_n is a viscosity solution of:

$$\left(\frac{\partial}{\partial t}u_n\right)(t, x) + G_n(t, x, u_n(t, x), (\nabla_x u_n)(t, x), (\text{Hess}_x u_n)(t, x)) = 0 \quad (3.2.35)$$

for $(t, x) \in (0, T) \times \mathcal{O}$, then we have that u_0 is a viscosity solution of:

$$\left(\frac{\partial}{\partial t}u_0\right)(t, x) + G_0(t, x, u_0(t, x), (\nabla_x u_0)(t, x), (\text{Hess}_x u_0)(t, x)) = 0 \quad (3.2.36)$$

Proof. Note that Lemma 3.2.11 gives us that u_0 is a viscosity solution of:

$$\left(\frac{\partial}{\partial t}u_0\right)(t, x) + G_n(t, x, u_0(t, x), (\nabla_x u_0)(t, x), (\text{Hess}_x u_0)(t, x)) \geq 0 \quad (3.2.37)$$

for $(t, x) \in (0, T) \times \mathcal{O}$. Also note that Corollary 3.2.11.1 ensures that u_0 is a viscosity solution of:

$$\left(\frac{\partial}{\partial t}u_0\right)(t, x) + G_n(t, x, u_0(t, x), (\nabla_x u_0)(t, x), (\text{Hess}_x u_0)(t, x)) \leq 0 \quad (3.2.38)$$

Taken together these prove the corollary. \square

Lemma 3.2.12. *For all $a, b \in \mathbb{R}$ it is the case that $(a + b)^2 \leq 2a^2 + 2b^2$.*

Proof. Since for all $a, b \in \mathbb{R}$ it is the case that $(a - b)^2 \geq 0$ we then have that:

$$\begin{aligned} (a + b)^2 &\leq (a + b)^2 + (a - b)^2 \\ &\leq a^2 + 2ab + b^2 + a^2 - 2ab + b^2 \\ &= 2a^2 + 2b^2 \end{aligned}$$

This completes the proof. \square

Lemma 3.2.13. *Let $d, m \in \mathbb{N}$, $T \in (0, \infty)$. Let $\mathcal{O} \subseteq \mathbb{R}^d$ be a non-empty compact set, and for all $n \in \mathbb{N}_0$, $\mu_n \in C([0, T] \times \mathcal{O}, \mathbb{R})$, $\sigma_n \in C([0, T] \times \mathcal{O}, \mathbb{R}^{d \times m})$ assume also:*

$$\limsup_{n \rightarrow \infty} \left[\sup_{t \in [0, T]} \sup_{x \in \mathcal{O}} (\|\mu_n(t, x) - \mu_0(t, x)\|_E + \|\sigma_n(t, x) - \sigma_0(t, x)\|_F) \right] = 0 \quad (3.2.39)$$

Let $(\Omega, \mathcal{F}, \mathbb{R})$ be a stochastic basis and let $W : [0, T] \times \Omega \rightarrow \mathbb{R}^m$ be a standard $(\mathbb{F}_t)_{t \in [0, T]}$ -Brownian motion for every $t \in [0, T]$, $x \in \mathcal{O}$, let $\mathcal{X}^{t,x} = (\mathcal{X}_s^{t,x})_{s \in [t, T]} : [t, T] \times \Omega \rightarrow \mathbb{R}^d$ be an $(\mathbb{F}_s)_{s \in [t, T]}$ adapted stochastic process with continuous sample paths, satisfying for all $s \in [t, T]$ we have \mathbb{P} -a.s.

$$\mathcal{X}_s^{n,t,x} = x + \int_t^s \mu_n(r, \mathcal{X}_r^{n,t,x}) dr + \int_t^s \sigma_n(r, \mathcal{X}_r^{n,t,x}) dW_r \quad (3.2.40)$$

then it is the case that:

$$\limsup_{n \rightarrow \infty} \left[\sup_{t \in [0, T]} \sup_{s \in [t, T]} \sup_{x \in \mathcal{O}} \left(\mathbb{E} \left[\|\mathcal{X}_s^{n,t,x} - \mathcal{X}_s^{0,t,x}\|_E^2 \right] \right) \right] = 0 \quad (3.2.41)$$

for $(t, x) \in (0, T) \times \mathbb{R}^d$.

Proof. Since \mathcal{O} is compact, let $L \in \mathbb{R}$ be such that for all $t \in [0, T]$, $x, y \in \mathcal{O}$ it is the case that:

$$\|\mu_0(t, x) - \mu_0(t, y)\|_E - \|\sigma_0(t, x) + \sigma_0(t, y)\|_F \leq L\|x - y\|_E \quad (3.2.42)$$

Furthermore (Karatzas and Shreve, 1991, Theorem 5.2.9) tells us that:

$$\sup_{s \in [t, T]} \mathbb{E} \left[\|\mathcal{X}_s^{n,t,x}\|_E \right] < \infty \quad (3.2.43)$$

Note now that (3.2.40) tells us that:

$$\mathcal{X}_s^{n,t,x} - \mathcal{X}_s^{0,t,x} = \int_t^s \mu_n(r, \mathcal{X}_r^{n,t,x}) - \mu_0(r, \mathcal{X}_r^{0,t,x}) dr + \int_t^s \sigma_n(r, \mathcal{X}_r^{n,t,x}) - \sigma_0(r, \mathcal{X}_r^{0,t,x}) dW_r \quad (3.2.44)$$

Minkowski's Inequality applied to (3.2.44) then tells us for all $n \in \mathbb{N}$, $t \in [0, T]$, $s \in [t, T]$, and $x \in \mathcal{O}$ that:

$$\begin{aligned} (\mathbb{E} [\|\mathcal{X}_s^{n,t,x} - \mathcal{X}_s^{0,t,x}\|_E])^{\frac{1}{2}} &\leq \int_t^s \left(\mathbb{E} [\|\mu_n(r, \mathcal{X}_r^{n,t,x}) - \mu_0(r, \mathcal{X}_r^{0,t,x})\|_E^2] \right)^{\frac{1}{2}} dr + \\ &\quad \left(\mathbb{E} \left[\left\| \int_t^s (\sigma_n(r, \mathcal{X}_r^{n,t,x}) - \sigma_0(r, \mathcal{X}_r^{0,t,x})) dW_r \right\|_E^2 \right] \right)^{\frac{1}{2}} \end{aligned} \quad (3.2.45)$$

Itô's isometry applied to the second summand yields:

$$\begin{aligned} (\mathbb{E} [\|\mathcal{X}_s^{n,t,x} - \mathcal{X}_s^{0,t,x}\|_E])^{\frac{1}{2}} &\leq \int_t^s \left(\mathbb{E} [\|\mu_n(r, \mathcal{X}_r^{n,t,x}) - \mu_0(r, \mathcal{X}_r^{0,t,x})\|_E^2] \right)^{\frac{1}{2}} dr + \\ &\quad \left(\int_t^s \mathbb{E} [\|\sigma_n(r, \mathcal{X}_r^{n,t,x}) - \sigma_0(r, \mathcal{X}_r^{0,t,x})\|_F^2] dr \right)^{\frac{1}{2}} \end{aligned} \quad (3.2.46)$$

Applying Lemma 3.2.12 followed by the Cauchy-Schwarz Inequality then gives us for all $n \in \mathbb{N}$, $t \in [0, T]$, $s \in [t, T]$, and $x \in \mathcal{O}$ that:

$$\begin{aligned} \mathbb{E} [\|\mathcal{X}_s^{n,t,x} - \mathcal{X}_s^{0,t,x}\|_E^2] &\leq 2 \left[\int_t^s \left(\mathbb{E} [\|\mu_n(r, \mathcal{X}_r^{n,t,x}) - \mu_0(r, \mathcal{X}_r^{0,t,x})\|_E^2] \right)^{\frac{1}{2}} dr \right]^2 \\ &\quad + 2 \int_t^s \mathbb{E} [\|\sigma_n(r, \mathcal{X}_r^{n,t,x}) - \sigma_0(r, \mathcal{X}_r^{0,t,x})\|_F^2] dr \\ &\leq 2T \int_t^s \mathbb{E} [\|\mu_n(r, \mathcal{X}_r^{n,t,x}) - \mu_0(r, \mathcal{X}_r^{0,t,x})\|_E^2] dr \\ &\quad + 2 \int_t^s \mathbb{E} [\|\sigma_n(r, \mathcal{X}_r^{n,t,x}) - \sigma_0(r, \mathcal{X}_r^{0,t,x})\|_F^2] dr \end{aligned} \quad (3.2.47)$$

Applying Lemma 3.2.12 again to each summand then yields for all $n \in \mathbb{N}$, $t \in [0, T]$ $s \in [t, T]$, and

$x \in \mathcal{O}$ it is the case that:

$$\begin{aligned}
& \mathbb{E} \left[\left\| \mathcal{X}_s^{n,t,x} - \mathcal{X}_s^{0,t,x} \right\|^2 \right] \\
& \leq 2T \int_t^s \left(2\mathbb{E} \left[\left\| \mu_n(r, \mathcal{X}_r^{n,t,x}) - \mu_0(r, \mathcal{X}_r^{n,t,x}) \right\|_E^2 \right] + 2\mathbb{E} \left[\left\| \mu_0(r, \mathcal{X}_r^{n,t,x}) - \mu_0(r, \mathcal{X}_r^{0,t,x}) \right\|_E^2 \right] \right) dr \\
& + 2 \int_t^s \left(2\mathbb{E} \left[\left\| \sigma_n(r, \mathcal{X}_r^{n,t,x}) - \sigma_0(r, \mathcal{X}_r^{n,t,x}) \right\|_F^2 \right] + 2\mathbb{E} \left[\left\| \sigma_0(r, \mathcal{X}_r^{n,t,x}) - \sigma_0(r, \mathcal{X}_r^{0,t,x}) \right\|_F \right] \right) dr \quad (3.2.48)
\end{aligned}$$

However assumption (3.2.42) then gives us that for all $n \in \mathbb{N}$, $t \in [0, T]$, $s \in [t, T]$, and $x \in \mathcal{O}$ that:

$$\begin{aligned}
\mathbb{E} \left[\left\| \mathcal{X}_s^{n,t,x} - \mathcal{X}_s^{0,t,x} \right\|_E^2 \right] & \leq 4L^2(T+1) \int_t^s \mathbb{E} \left[\left\| \mathcal{X}_r^{n,t,x} - \mathcal{X}_r^{0,t,x} \right\|_E^2 \right] dr \\
& + 4T(T+1) \left[\sup_{r \in [0, T]} \sup_{y \in \mathbb{R}^d} \left(\left\| \mu_n(r, y) - \mu_0(r, y) \right\|_E^2 + \left\| \sigma_n(r, y) - \sigma_0(r, y) \right\|_F^2 \right) \right]
\end{aligned}$$

Finally Gronwall's Inequality with assumption (3.2.43) gives us for all $n \in \mathbb{N}$, $t \in [0, T]$, $s \in [t, T]$, $x \in \mathcal{O}$ that:

$$\begin{aligned}
& \mathbb{E} \left[\left\| \mathcal{X}_s^{n,t,x} - \mathcal{X}_s^{0,t,x} \right\|_E^2 \right] \\
& \leq 4T(T+1) \left[\sup_{r \in [0, T]} \sup_{y \in \mathbb{R}^d} \left(\left\| \mu_n(r, y) - \mu_0(r, y) \right\|_E^2 + \left\| \sigma_n(r, y) - \sigma_0(r, y) \right\|_F^2 \right) \right] e^{4L^2T(T+1)} \quad (3.2.49)
\end{aligned}$$

Applying $\limsup_{n \rightarrow \infty}$ to both sides and applying (3.2.39) gives us for all $n \in \mathbb{N}$, $t \in [0, T]$, $s \in [t, T]$, $x \in \mathcal{O}$ that:

$$\begin{aligned}
& \limsup_{n \rightarrow \infty} \mathbb{E} \left[\left\| \mathcal{X}_s^{n,t,x} - \mathcal{X}_s^{0,t,x} \right\|_E^2 \right] \\
& \leq \limsup_{n \rightarrow \infty} \left[4T(T+1) \left[\sup_{r \in [0, T]} \sup_{y \in \mathbb{R}^d} \left(\left\| \mu_n(r, y) - \mu_0(r, y) \right\|_E^2 + \left\| \sigma_n(r, y) - \sigma_0(r, y) \right\|_F^2 \right) \right] e^{4L^2T(T+1)} \right] \\
& \leq 4T(T+1) \left[\limsup_{n \rightarrow \infty} \left[\sup_{r \in [0, T]} \sup_{y \in \mathbb{R}^d} \left(\left\| \mu_n(r, y) - \mu_0(r, y) \right\|_E^2 + \left\| \sigma_n(r, y) - \sigma_0(r, y) \right\|_F^2 \right) \right] \right] e^{4L^2T(T+1)} \\
& \leq 0
\end{aligned}$$

This completes the proof. \square

Lemma 3.2.14. *Let $d, m \in \mathbb{N}$, $T \in (0, \infty)$, let $\mathcal{O} \subseteq [0, T] \times \mathbb{R}^d$, let $\mu \in C([0, T] \times \mathcal{O}, \mathbb{R}^d)$ and $\sigma \in C([0, T] \times \mathcal{O}, \mathbb{R}^{d \times m})$ have compact supports such that $\text{supp}(\mu) \cup \text{supp}(\sigma) \subseteq [0, T] \times \mathcal{O}$ let*

$g \in C(\mathbb{R}^d, \mathbb{R})$. Let $(\Omega, \mathcal{F}, \mathbb{P}, (\mathbb{F}_t)_{t \in [0, T]})$ be a stochastic basis, let $W : [0, T] \times \Omega \rightarrow \mathbb{R}^m$ be a standard $(\mathbb{F}_t)_{t \in [0, T]}$ Brownian motion, for every $t \in [0, T]$, $x \in \mathbb{R}^d$, let $\mathcal{X}^{t, x} = (\mathcal{X}_s^{t, x})_{s \in [t, T]} : [t, T] \times \Omega \rightarrow \mathbb{R}^d$ be an $(\mathbb{F}_s)_{s \in [t, T]}$ adapted stochastic process with continuous sample paths satisfying for all $s \in [t, T]$ with \mathbb{F} -a.s. that:

$$\mathcal{X}_s^{t, x} = x + \int_t^s \mu(r, \mathcal{X}_r^{t, x}) dr + \int_t^s \sigma(r, \mathcal{X}_r^{t, x}) dW_r \quad (3.2.50)$$

and further let $u : [0, T] \times \mathbb{R}^d \rightarrow \mathbb{R}$ satisfy for all $t \in [0, T]$, $x \in \mathbb{R}^d$ that:

$$u(t, x) = \mathbb{E} \left[g \left(\mathcal{X}_T^{t, x} \right) \right] \quad (3.2.51)$$

Then u is a viscosity solution of:

$$\left(\frac{\partial}{\partial t} u \right) (t, x) + \frac{1}{2} \text{Trace} (\sigma(t, x) [\sigma(t, x)]^* (\text{Hess}_x u) (t, x)) + \langle \mu(t, x), (\nabla_x u) (t, x) \rangle = 0 \quad (3.2.52)$$

and where $u(T, x) = g(x)$ for $(t, x) \in (0, T) \times \mathcal{O}$.

Proof. Let $\mathcal{S} = \text{supp}(\mu) \cup \text{supp}(\sigma) \subseteq [0, T] \times \mathcal{O}$ be bounded in space by $\rho \in (0, \infty)$, as $\mathcal{S} \subseteq [0, T] \times (-\rho, \rho)^d$. This exists as the supports are compact and thus by Heine-Börel is closed and bounded. Let $\mathfrak{s}_n, \mathfrak{m}_n \in C^\infty([0, T] \times \mathbb{R}^d, \mathbb{R}^{d \times n})$ where $\bigcup_{n \in \mathbb{N}} [\text{supp}(\mathfrak{s}_n) \cup \text{supp}(\mathfrak{m}_n)] \subseteq [0, T] \times (-\rho, \rho)^d$ satisfy for $n \in \mathbb{N}$ that:

$$\limsup_{n \rightarrow \infty} \left[\sup_{t \in [0, T]} \sup_{x \in \mathbb{R}^d} (\|\mathfrak{m}_n(t, x) - \mu(t, x)\|_E + \|\mathfrak{s}_n - \sigma(t, x)\|_F) \right] = 0 \quad (3.2.53)$$

We construct a set of degenerate elliptic functions, $G^n : (0, T) \times \mathbb{R}^d \times \mathbb{R} \times \mathbb{R}^d \times \mathbb{S}_d \rightarrow \mathbb{R}$ with $n \in \mathbb{N}_0$ such that:

$$G^0(t, x, r, p, A) = \frac{1}{2} \text{Trace} (\sigma(t, x) [\sigma(t, x)]^* A) + \langle \mu(t, x), p \rangle \quad (3.2.54)$$

and

$$G^n(t, x, r, p, A) = \frac{1}{2} \text{Trace} (\mathfrak{s}_n(t, x) [\mathfrak{s}_n(t, x)]^* A) + \langle \mu(t, x), p \rangle \quad (3.2.55)$$

Also let $\mathbf{g}_n \in C^\infty(\mathbb{R}^d, \mathbb{R})$ for $n \in \mathbb{N}$ satisfy for all $n \in \mathbb{N}$ that:

$$\limsup_{n \rightarrow \infty} \sup_{t \in [0, T]} \sup_{x \in \mathbb{R}^d} (\|\mathbf{g}_n(x) - g(x)\|_E) = 0 \quad (3.2.56)$$

Further let $\mathfrak{X}^{n,t,x} = (\mathfrak{X}_s^{n,t,x})_{s \in [t, T]} : [t, T] \times \Omega \rightarrow \mathbb{R}^d$ be an $(\mathbb{F}_s)_{s \in [t, T]}$ -adapted stochastic process with continuous sample paths that satisfy:

$$\mathfrak{X}_s^{n,t,x} = x + \int_t^s \mathbf{m}_n(r, \mathfrak{X}_r^{n,t,x}) dr + \int_t^s \mathfrak{s}_n(r, \mathfrak{X}_r^{n,t,x}) dW_r \quad (3.2.57)$$

Finally let $\mathbf{u}^n : [0, T] \times \mathbb{R}^d \rightarrow \mathbb{R}$ for $n \in \mathbb{N}$ be:

$$\mathbf{u}^n = \mathbb{E} \left[\mathbf{g}_n \left(\mathfrak{X}_T^{n,t,x} \right) \right] \quad (3.2.58)$$

and:

$$\mathbf{u}^0 = \mathbb{E} \left[\mathbf{g}_n \left(\mathfrak{X}_T^{t,x} \right) \right] \quad (3.2.59)$$

Note that (Beck et al., 2021b, Lemma 2.2) with $g \curvearrowright \mathbf{g}_k$, $\mu \curvearrowright \mathbf{m}_n$, $\sigma \curvearrowright \mathfrak{s}_n$, $\mathfrak{X}^{t,x} \curvearrowright \mathfrak{X}^{n,t,x}$ gives us $\mathbf{u}^n \in C^{1,2}([0, T] \times \mathbb{R}^d, \mathbb{R})$, and $\mathbf{u}^n(t, x) = \mathbf{g}_k(x)$ where:

$$\left(\frac{\partial}{\partial t} \mathbf{u}^n \right) (t, x) + \frac{1}{2} \text{Trace} (\mathfrak{s}_n(t, x) [\mathfrak{s}_n(t, x)]^* (\text{Hess}_x \mathbf{u}^n) (t, x)) + \langle \mathbf{m}_n(t, x), (\nabla_x \mathbf{u}^n) (t, x) \rangle = 0 \quad (3.2.60)$$

And by Definitions 3.2.7, 3.2.8, and 3.2.9 we have that \mathbf{u}^n is a viscosity solution of

$$\left(\frac{\partial}{\partial t} \mathbf{u}^n \right) (t, x) + \frac{1}{2} \text{Trace} (\mathfrak{s}_n(t, x) [\mathfrak{s}_n(t, x)]^* (\text{Hess}_x \mathbf{u}^n) (t, x)) + \langle \mathbf{m}_n(t, x), (\nabla_x \mathbf{u}^n) (t, x) \rangle = 0 \quad (3.2.61)$$

for $(t, x) \in (0, T) \times \mathbb{R}^d$.

Since for all $n \in \mathbb{N}$, it is the case that $\mathcal{S} = (\text{supp}(\mathbf{m}_n) \cup \text{supp}(\mathfrak{s}_n) \cup \text{supp}(\mu) \cup \text{supp}(\sigma)) \subseteq [0, T] \times (-\rho, \rho)^d$ and because of (3.2.50) of (3.2.57) we have that (Beck et al., 2021a, Lemma 3.2, Item (ii)) which yields that for all $n \in \mathbb{N}$, $t \in [0, T]$, $x \in \mathbb{R}^d \setminus (-\rho, \rho)^d$ that $\mathbb{P}(\forall s \in [t, T] : \mathfrak{X}_s^{n,t,x} = x = \mathfrak{X}_s^{t,x}) =$

1. This in turn shows that for all $n \in \mathbb{N}$, $x \in \mathbb{R}^d \setminus (-\rho, \rho)^d$ that $\mathbf{u}^n(t, x) = \mathbf{u}^0(t, x)$ which along with (3.2.58) and (3.2.59) yields that:

$$\begin{aligned} \sup_{t \in [0, T]} \sup_{x \in \mathbb{R}^d} [|\mathbf{u}^n(t, x) - \mathbf{u}^0(t, x)|] &= \sup_{t \in [0, T]} \sup_{x \in (-\rho, \rho)^d} [|\mathbf{u}^n(t, x) - \mathbf{u}^0(t, x)|] \\ &\leq \sup_{t \in [0, T]} \sup_{x \in (-\rho, \rho)^d} \left(\mathbb{E} \left[\left| \mathfrak{g}_k \left(\mathfrak{X}_T^{n, t, x} \right) - \mathfrak{g} \left(\mathfrak{X}_T^{t, x} \right) \right| \right] \right) \end{aligned} \quad (3.2.62)$$

Note that Lemma 3.2.13 allows us to conclude that:

$$\limsup_{n \rightarrow \infty} \left[\sup_{t \in [0, T]} \sup_{x \in (-\rho, \rho)^d} \left(\mathbb{E} \left[\left\| \mathfrak{X}_T^{n, t, x} - \mathfrak{X}_s^{t, x} \right\| \right] \right) \right] = 0 \quad (3.2.63)$$

But then we have that (3.2.62) which yields that:

$$\limsup_{n \rightarrow \infty} \left[\sup_{t \in [0, T]} \sup_{x \in \mathbb{R}^d} (|\mathbf{u}^n(t, x) - \mathbf{u}^0(t, x)|) \right] = 0 \quad (3.2.64)$$

However now note that (3.2.55) and (3.2.61) thus yield that for $n \in \mathbb{N}_0$, \mathbf{u}^n is a viscosity solution to:

$$\left(\frac{\partial}{\partial t} \mathbf{u}^n \right) (t, x) + G^n (t, x, \mathbf{u}^n (t, x), (\nabla_x \mathbf{u}^n) (t, x), (\text{Hess}_x \mathbf{u}^n) (t, x)) = 0 \quad (3.2.65)$$

But since we've established (3.2.53) we have that for a non-empty compact set $\mathcal{C} \subseteq (0, T) \times \mathcal{O} \times \mathbb{R} \times \mathbb{R}^d \times \mathbb{S}_d$ that:

$$\begin{aligned} &\limsup_{n \rightarrow \infty} \left[\sup_{(t, x, r, p, A) \in \mathcal{C}} |G^n (t, x, r, p, A) - G^0 (t, x, r, p, A)| \right] \\ &\leq \limsup_{n \rightarrow \infty} \left[\sup_{(t, x, r, p, A) \in \mathcal{C}} \|\mu(t, x) - \mathfrak{m}_n(t, x)\|_E \|p\|_E \right] \\ &+ \limsup_{n \rightarrow \infty} \left[\sup_{(t, x, r, p, A) \in \mathcal{C}} \|\sigma(t, x) [\sigma(t, x)]^* - \mathfrak{s}_n(t, x) [\mathfrak{s}_n(t, x)]^*\|_F \|A\|_F \right] = 0 \end{aligned} \quad (3.2.66)$$

This, together with (3.2.64), (3.2.65) and Corollary 3.2.11.2 yields that \mathbf{u}^0 is also a viscosity solution

to:

$$\left(\frac{\partial}{\partial t} u^0\right)(t, x) + G^0(t, x, u^0(t, x), (\nabla_x u^0)(t, x), (\text{Hess}_x)(t, x)) = 0 \quad (3.2.67)$$

Finally note that (3.2.53), (3.2.57), (3.2.59), and (3.2.67) yield that u is a viscosity solution of::

$$\left(\frac{\partial}{\partial t} u\right)(t, x) + \frac{1}{2} \text{Trace}(\sigma(t, x) [\sigma(t, x)]^* (\text{Hess}_x u)(t, x)) + \langle \mu(t, x), (\nabla_x)(t, x) \rangle = 0 \quad (3.2.68)$$

for $(t, x) \in [0, T] \times \mathbb{R}^d$. Finally (3.2.50) and (3.2.51) allows us to conclude that for all $x \in \mathbb{R}^d$ it is the case that $u(T, x) = g(x)$. This concludes the proof. \square

Lemma 3.2.15. *Let $d, m \in \mathbb{N}$, $T \in (0, \infty)$, further let $\mathcal{O} \subseteq \mathbb{R}^d$ be a non, empty compact set. Let every $r \in (0, \infty)$ satisfy the condition that $O_r \subseteq \mathcal{O}$, where $O_r = \{x \in \mathcal{O} : (\|x\|_E \leq r \text{ and } \{y \in \mathbb{R}^d : \|y - x\|_E < \frac{1}{r}\}) \subseteq \mathcal{O}\}$ let $g \in C(\mathcal{O}, \mathbb{R})$, $\mu \in C([0, T] \times \mathcal{O}, \mathbb{R})$, $V \in C^{1,2}([0, T] \times \mathcal{O}, (0, \infty))$, assume that for all $t \in [0, T]$, $x \in \mathcal{O}$ that:*

$$\sup \left(\left\{ \frac{\|\mu(t, x) - \mu(t, y)\|_E + \|\sigma(t, x) - \sigma(t, y)\|_F}{\|x - y\|_E} : t \in [0, T], x, y \in O_r, x \neq y \right\} \cup \{0\} \right) < \infty \quad (3.2.69)$$

$$\left(\frac{\partial}{\partial t} V\right)(t, x) + \frac{1}{2} \text{Trace}(\sigma(t, x) [\sigma(t, x)]^* (\text{Hess}_x V)(t, x)) + \langle \mu(t, x), (\nabla_x V)(t, x) \rangle \leq 0 \quad (3.2.70)$$

assume that $\sup_{r \in (0, \infty)} [\inf_{x \in \mathcal{O} \setminus O_r} V(t, x)] = \infty$ and $\inf_{r \in (0, \infty)} \left[\sup_{t \in [0, T]} \sup_{x \in \mathcal{O} \setminus O_r} \left(\frac{g(x)}{V(t, x)} \right) \right] = 0$. Let $(\Omega, \mathcal{F}, \mathbb{P}, (\mathbb{F}_t)_{t \in [0, T]})$ be a stochastic basis and let $W : [0, T] \times \Omega \rightarrow \mathbb{R}^m$ be a standard $(\mathbb{F}_t)_{t \in [0, T]}$ -Brownian motion, for every $t \in [0, T]$, $x \in \mathcal{O}$ let $\mathcal{X}^{t, x} = (\mathcal{X}_s^{t, x})_{s \in [t, T]} : [t, T] \times \Omega \rightarrow \mathcal{O}$ be an $(\mathbb{F}_s)_{s \in [t, T]}$ -adapted stochastic process with continuous sample paths satisfying that for all $s \in [t, T]$, we have \mathbb{P} -a.s. that:

$$\mathcal{X}_s^{t, x} = x + \int_t^s \mu(r, \mathcal{X}_r^{t, x}) dr + \int_t^s \sigma(r, \mathcal{X}_r^{t, x}) dW_r \quad (3.2.71)$$

also let $u : [0, T] \times \mathbb{R}^d \rightarrow \mathbb{R}$ satisfy for all $t \in [0, T]$, $x \in \mathbb{R}^d$ that:

$$u(t, x) = \mathbb{E} \left[u(T, \mathcal{X}_T^{t,x}) \right] \quad (3.2.72)$$

It is then the case that u is a viscosity solution to:

$$\left(\frac{\partial}{\partial t} u \right) (t, x) + \frac{1}{2} \text{Trace} (\sigma(t, x) [\sigma(t, x)]^* (\text{Hess}_x u) (t, x)) + \langle \mu(t, x), (\nabla_x) (t, x) \rangle = 0 \quad (3.2.73)$$

for $(t, x) \in (0, T) \times \mathcal{O}$ with $u(T, x) = g(x)$.

Proof. Let it be the case, that throughout the proof, for $n \in \mathbb{N}$, we have that $\mathbf{g}_n \in C(\mathbb{R}^d, \mathbb{R})$, compactly supported and that $[\bigcup_{n \in \mathbb{N}} \text{supp}(\mathbf{g}_n)] \subseteq [0, T] \times \mathcal{O}$ and further that:

$$\limsup_{n \rightarrow \infty} \left[\sup_{t \in [0, T]} \sup_{x \in \mathcal{O}} \left(\frac{|\mathbf{g}_n(x) - g(x)|}{V(T, x)} \right) \right] = 0 \quad (3.2.74)$$

Let it also be the case that for $n \in \mathbb{N}$, $\mathbf{m}_n \in C([0, T] \times \mathbb{R}^d, \mathbb{R}^d)$ and $\mathbf{s}_n \in C([0, T] \times \mathbb{R}^d, \mathbb{R}^{d \times m})$ satisfy:

(i) for all $n \in \mathbb{N}$:

$$\sup_{t \in [0, T]} \sup_{x, y \in \mathbb{R}^d, x \neq y} \left[\frac{\|\mathbf{m}_n(t, y) - \mathbf{m}_n(t, x)\|_E + \|\mathbf{s}_n(t, x) - \mathbf{s}_n(t, y)\|_E}{\|x - y\|_E} \right] = 0 \quad (3.2.75)$$

(ii) for all $n \in \mathbb{N}$, $t \in [0, T]$, $x \in \mathcal{O}$:

$$\mathbb{1}_{\{V \leq n\}}(t, x) [\|\mathbf{m}_n(t, x) - \mu(t, x)\|_E + \|\mathbf{s}_n(t, x) - \sigma(t, x)\|_F] = 0 \quad (3.2.76)$$

and

(iii) for all $n \in \mathbb{N}$, $t \in [0, T]$, $x \in \mathbb{R}^d \setminus \{V \leq n + 1\}$ that:

$$\|\mathbf{m}_n(t, x)\|_E + \|\mathbf{s}_n(t, x)\|_F = 0 \quad (3.2.77)$$

Next for every $n \in \mathbb{N}$, $t \in [0, T]$ and $x \in \mathbb{R}^d$ let it be the case that $\mathfrak{X}_s^{n,t,x} = (\mathfrak{X}_s^{n,t,x})_{s \in [t, T]} : [t, T] \times \Omega \rightarrow$

\mathbb{R}^d be a stochastic process with continuous sample paths satisfying:

$$\mathfrak{X}_s^{n,t,x} = x + \int_t^s \mathfrak{m}_n(r, \mathfrak{X}_r^{n,t,x}) dr + \int_t^s \mathfrak{s}_n(r, \mathfrak{X}_r^{n,t,x}) dW_r \quad (3.2.78)$$

Let $\mathbf{u}^n : [0, T] \times \mathbb{R}^d \rightarrow \mathbb{R}$, $k \in \mathbb{N}$, $n \in \mathbb{N}_0$, satisfy for all $n \in \mathbb{N}$, $t \in [0, T]$, $x \in \mathbb{R}^d$ that:

$$\mathbf{u}^{n,k}(t, x) = \mathbb{E} \left[\mathfrak{g}_k(\mathfrak{X}_T^{n,t,x}) \right] \quad (3.2.79)$$

and

$$\mathbf{u}^{0,k}(t, x) = \mathbb{E} \left[\mathfrak{g}_k(\mathcal{X}_T^{t,x}) \right] \quad (3.2.80)$$

and finally let, for every $n \in \mathbb{N}$, $t \in [0, T]$, $x \in \mathcal{O}$, there be $\mathfrak{t}_n^{t,x} : \Omega \rightarrow [t, T]$ which satisfy $\mathfrak{t}_n^{t,x} = \inf \left(\{s \in [t, T], \max\{V(s, \mathfrak{X}_s^{t,x}), V(s, \mathcal{X}_s^{t,x})\} \geq n\} \cup \{T\} \right)$. We may apply Lemma 3.2.14 with $\mu \frown \mathfrak{m}_n$, $\sigma \frown \mathfrak{s}_n$, $g \frown \mathfrak{g}_k$ to show that for all $n, k \in \mathbb{N}$ we have that $\mathbf{u}^{n,k}$ is a viscosity solution to:

$$\left(\frac{\partial}{\partial t} \mathbf{u}^{n,k} \right) (t, x) + \frac{1}{2} \text{Trace} \left(\mathfrak{s}_n(t, x) [\mathfrak{s}_n(t, x)]^* \left(\text{Hess}_x \mathbf{u}^{n,k} \right) (t, x) \right) + \langle \mathfrak{m}_n(t, x), \left(\nabla_x \mathbf{u}^{n,k} \right) (t, x) \rangle = 0 \quad (3.2.81)$$

for $(t, x) \in (0, T) \times \mathbb{R}^d$. But note that items (i)-(iii) and 3.2.78 give us that, in line with (Beck et al., 2021a, Lemma 3.5):

$$\mathbb{P} \left(\forall s \in [t, T] : \mathbb{1}_{\{s \leq \mathfrak{t}_n^{t,x}\}} \mathfrak{X}_s^{n,t,x} = \mathbb{1}_{\{s \leq \mathfrak{t}_n^{t,x}\}} \mathcal{X}_s^{t,x} \right) = 1 \quad (3.2.82)$$

Further this implies that for all $n, k \in \mathbb{N}$, $t \in [0, T]$, $x \in \mathcal{O}$ that:

$$\begin{aligned} \mathbb{E} \left[\left| \mathfrak{g}_k(\mathfrak{X}_T^{n,t,x}) - \mathfrak{g}_k(\mathcal{X}_T^{t,x}) \right| \right] &= \mathbb{E} \left[\mathbb{1}_{\{\mathfrak{t}_n^{t,x} < T\}} \left| \mathfrak{g}_k(\mathfrak{X}_T^{n,t,x}) - \mathfrak{g}_k(\mathcal{X}_T^{t,x}) \right| \right] \\ &\leq 2 \left[\sup_{y \in \mathcal{O}} |\mathfrak{g}_k(y)| \right] \mathbb{P}(\mathfrak{t}_n^{t,x} < T) \end{aligned}$$

Note that this combined with (Beck et al., 2021a, Lemma 3.1) implies for all $t \in [0, T]$, $x \in \mathcal{O}$,

$n \in \mathbb{N}$ we have that $\mathbb{E} \left[V \left(\mathfrak{t}_n^{t,x}, \mathcal{X}_{\mathfrak{t}_n^{t,x}}^{t,x} \right) \right] \leq V(t, x)$, which then further proves that:

$$\begin{aligned}
\left| \mathbf{u}^{n,k}(t, x) - \mathbf{u}^{0,k}(t, x) \right| &\leq 2 \left[\sup_{y \in \mathcal{O}} |\mathfrak{g}_k(y)| \right] \mathbb{P} \left(\mathfrak{t}_n^{t,x} < T \right) \\
&\leq 2 \left[\sup_{y \in \mathcal{O}} |\mathfrak{g}_k(y)| \right] \mathbb{P} \left(V \left(\mathfrak{t}_n^{t,x}, \mathcal{X}_{\mathfrak{t}_n^{t,x}}^{t,x} \right) \geq n \right) \\
&\leq \frac{2}{n} \left[\sup_{y \in \mathcal{O}} |\mathfrak{g}_k(y)| \right] \mathbb{E} \left[V \left(\mathfrak{t}_n^{t,x}, \mathcal{X}_{\mathfrak{t}_n^{t,x}}^{t,x} \right) \right] \\
&\leq \frac{2}{n} \left[\sup_{y \in \mathcal{O}} |\mathfrak{g}_k(y)| \right] V(t, x)
\end{aligned}$$

Together these imply that for all $k \in \mathbb{N}$ and compact $\mathcal{K} \subseteq [0, T] \times \mathcal{O}$:

$$\limsup_{k \rightarrow \infty} \left[\sup_{(t,x) \in \mathcal{K}} \left(\left| \mathbf{u}^{n,k}(t, x) - \mathbf{u}^{0,k}(t, x) \right| \right) \right] = 0 \tag{3.2.83}$$

But again note that since we have that $\sup_{r \in (0, \infty)} \left[\inf_{t \in [0, T], x \in \mathbb{R}^d \setminus \mathcal{O}_r} V(t, x) \right] = \infty$ and (3.2.76) tell us that for all compact $\mathcal{K} \subseteq [0, T] \times \mathcal{O}$ we have that:

$$\limsup_{n \rightarrow \infty} \left[\sup_{(t,x) \in \mathcal{K}} \left(\|\mathfrak{m}_n(t, x) - \mu(t, x)\|_E + \|\mathfrak{s}_n(t, x) - \sigma(t, x)\|_F \right) \right] = 0 \tag{3.2.84}$$

Note that (3.2.81), (3.2.83) and Corollary 3.2.11.2 tell us that for all $k \in \mathbb{N}$ we have that $\mathbf{u}^{0,k}$ is a viscosity solution to:

$$\left(\frac{\partial}{\partial t} \mathbf{u}^{0,k} \right) (t, x) + \frac{1}{2} \text{Trace} \left(\sigma(t, x) [\sigma(t, x)]^* \left(\text{Hess}_x \mathbf{u}^{0,k} \right) (t, x) \right) + \langle \mu(t, x), \left(\nabla_x \mathbf{u}^{0,k} \right) (t, x) \rangle = 0 \tag{3.2.85}$$

for $(t, x) \in (0, T) \times \mathcal{O}$. However note that (3.2.71), (3.2.74), (3.2.80) prove that for all compact $\mathcal{K} \subseteq [0, T] \times \mathcal{O}$ we have:

$$\limsup_{k \rightarrow \infty} \left[\sup_{(t,x) \in \mathcal{K}} \left| \mathbf{u}^{0,k}(t, x) - u(t, x) \right| \right] = 0 \tag{3.2.86}$$

This together with (3.2.85), (3.2.74), Corollary 3.2.11.2 shows that u_0 is a viscosity solution to:

$$\left(\frac{\partial}{\partial t} u\right)(t, x) + \frac{1}{2} \text{Trace}(\sigma(t, x) [\sigma(t, x)]^* (\text{Hess}_x u)(t, x)) + \langle \mu(t, x), (\nabla_x u) \rangle = 0 \quad (3.2.87)$$

for $(t, x) \in (0, T) \times \mathcal{O}$. By (3.2.73) we are ensured that for all $x \in \mathbb{R}^d$ we have that $u(T, x) = g(x)$ which together with proves the proposition. □

3.3 Solutions, Characterization, and Computational Bounds to the Kolmogorov Backward Equations

Theorem 3.3.1 (Existence and characterization of u_d). *Let $T \in (0, \infty)$. Let $(\Omega, \mathcal{F}, \mathbb{P})$ be a probability space. Let $\sigma_d \in C(\mathbb{R}^d, \mathbb{R}^{d \times d})$ and $\mu_d \in C(\mathbb{R}^d, \mathbb{R}^d)$ for $d \in \mathbb{N}$, let $u_d \in C^{1,2}([0, T] \times \mathbb{R}^d, \mathbb{R})$ satisfy for all $d \in \mathbb{N}$, $t \in [0, T]$, $x \in \mathbb{R}^d$ that:*

$$\left(\frac{\partial}{\partial t} u_d\right)(t, x) + \frac{1}{2} \text{Trace}(\sigma_d(x) [\sigma_d(x)]^* (\text{Hess}_x u_d)(t, x)) + \langle \mu_d(x), (\nabla_x u_d)(t, x) \rangle = 0 \quad (3.3.1)$$

let $\mathcal{W}^d : [0, T] \times \Omega \rightarrow \mathbb{R}^d$, $d \in \mathbb{N}$ be a standard Brownian motions and let $\mathcal{X}^{d,t,x} : [t, T] \times \Omega \rightarrow \mathbb{R}^d$, $d \in \mathbb{N}$, $t \in [0, T]$, be a stochastic process with continuous sample paths satisfying for all $d \in \mathbb{N}$, $t \in [0, T]$, $s \in [t, T]$, $x \in \mathbb{R}^d$, we have \mathbb{P} -a.s. that:

$$\mathcal{X}^{d,t,x} = x + \int_s^t \mu_d(\mathcal{X}_r^{d,t,x}) dr + \int_s^t \sigma(\mathcal{X}_r^{d,t,x}) d\mathcal{W}_r^d \quad (3.3.2)$$

Then for all $d \in \mathbb{N}$, $t \in [0, T]$, $x \in \mathbb{R}^d$, it holds that:

$$u_d(t, x) = \mathbb{E} \left[u_d \left(T, \mathcal{X}_t^{d,t,x} \right) \right] \quad (3.3.3)$$

Furthermore, u_d is a viscosity solution to (3.3.1).

Proof. This is a consequence of Lemma 3.1.2 and 3.2.14. □

Corollary 3.3.1.1. *Let $T \in (0, \infty)$, let $(\Omega, \mathcal{F}, \mathbb{P})$ be a probability space, let $u_d \in C^{1,2}([0, T] \times \mathbb{R}^d, \mathbb{R})$, $d \in \mathbb{N}$ satisfy for all $d \in \mathbb{N}$, $t \in [0, T]$, $x \in \mathbb{R}^d$ that:*

$$\left(\frac{\partial}{\partial t} u_d \right) (t, x) + \frac{1}{2} (\nabla_x^2 u_d) (t, x) = 0 \quad (3.3.4)$$

Let $\mathcal{W}^d : [0, T] \times \Omega \rightarrow \mathbb{R}^d$, $d \in \mathbb{N}$ be standard Brownian motions, and let $\mathcal{X}^{d,t,x} : [t, T] \times \Omega \rightarrow \mathbb{R}^d$, $d \in \mathbb{N}$, $t \in [0, T]$, $x \in \mathbb{R}^d$, be a stochastic process with continuous sample paths satisfying that for all $d \in \mathbb{N}$, $t \in [0, T]$, $s \in [t, T]$, $x \in \mathbb{R}^d$ we have \mathbb{P} -a.s. that:

$$\mathcal{X}_s^{d,t,x} = x + \int_t^s d\mathcal{W}_r^d = x + \mathcal{W}_{t-s}^d \quad (3.3.5)$$

Then for all $d \in \mathbb{N}$, $t \in [0, T]$, $x \in \mathbb{R}^d$ it holds that:

$$u_d(t, x) = \mathbb{E} \left[u_d \left(T, \mathcal{X}_t^{d,T,x} \right) \right] \quad (3.3.6)$$

Proof. This is a special case of Theorem 3.3.1. It is the case where $\sigma_d(x) = \mathbb{I}_d$, the uniform identity function where \mathbb{I}_d is the identity matrix in dimension d for $d \in \mathbb{N}$, and $\mu_d(x) = \mathbb{0}_{d,1}$ where $\mathbb{0}_d$ is the zero vector in dimension d for $d \in \mathbb{N}$. \square

Lemma 3.3.2. *Let $T \in (0, \infty)$, let $(\Omega, \mathcal{F}, \mathbb{P})$, be a probability space, let $\alpha_d \in C_b^2(\mathbb{R}^d, \mathbb{R})$, and $\alpha \in \mathcal{O}(x^2)$ for $d \in \mathbb{N}$, be infinitely often differentiable function, let $u_d \in C^{1,2}([0, T] \times \mathbb{R}^d, \mathbb{R})$, $d \in \mathbb{N}$, satisfy for all $d \in \mathbb{N}$, $t \in [0, T]$, $x \in \mathbb{R}^d$, that:*

$$\left(\frac{\partial}{\partial t} u_d \right) (t, x) + \frac{1}{2} (\nabla_x^2 u_d) (t, x) + \alpha_d(x) u_d(t, x) = 0 \quad (3.3.7)$$

Let $\mathcal{W}^d : [0, T] \times \Omega \rightarrow \mathbb{R}^d$ be standard Brownian motions and let $\mathcal{X}^{d,t,x} : [t, T] \times \Omega \rightarrow \mathbb{R}^d$, $d \in \mathbb{N}$, $t \in [0, T]$, $x \in \mathbb{R}^d$ be a stochastic process with continuous sample paths satisfying that for all $d \in \mathbb{N}$, $t \in [0, T]$, $s \in (t, T]$, $x \in \mathbb{R}^d$, we have \mathbb{P} -a.s. that:

$$\mathcal{X}_s^{d,t,x} = x + \int_s^t \frac{1}{2} d\mathcal{W}_r^d = \frac{1}{2} \mathcal{W}_{t-r}^d \quad (3.3.8)$$

Then for all $d \in \mathbb{N}$, $t \in [0, T]$, $x \in \mathbb{R}^d$ it holds that:

$$u_d(t, x) = \mathbb{E} \left[\exp \left(\int_t^T \alpha_d \left(\mathcal{X}_r^{d,t,x} \right) dr \right) u_d \left(T, \mathcal{X}_T^{d,t,x} \right) \right] \quad (3.3.9)$$

Proof. Let $v_d : \mathbb{R}^d \rightarrow \mathbb{R}$ be continuous. Throughout the proof let $u_d(t, x) = e^{-t\alpha_d(x)}v_d(t, x)$ for all $d \in \mathbb{N}$, $t \in [0, T]$, $x \in \mathbb{R}^d$. For notational simplicity, we will drop the d, t, x wherever it is obvious. Therefore the derivatives become:

$$u_t = -\alpha e^{-t\alpha}v + e^{-t\alpha}v_t \quad (3.3.10)$$

$$\frac{1}{2}\nabla_x^2 u = \frac{1}{2} \left[e^{-t\alpha}\nabla_x^2 v + 2\langle \nabla_x v, \nabla_x e^{-t\alpha} \rangle + v\nabla_x^2 e^{-t\alpha} \right] \quad (3.3.11)$$

This then renders (3.3.7) as:

$$\begin{aligned} \cancel{-\alpha e^{-t\alpha}v} + e^{-t\alpha}v_t + \frac{1}{2} \left[e^{-t\alpha}\nabla_x^2 v + 2\langle \nabla_x v, \nabla_x e^{-t\alpha} \rangle + v\nabla_x^2 e^{-t\alpha} \right] + \alpha e^{-t\alpha}v &= 0 \\ e^{-t\alpha}v_t + \frac{1}{2} \left[e^{-t\alpha}\nabla_x^2 v - 2te^{-t\alpha}\langle \nabla_x v, \nabla_x \alpha \rangle + v\nabla_x^2 e^{-t\alpha} \right] &= 0 \\ e^{-t\alpha}v_t + \frac{1}{2} \left[e^{-t\alpha}\nabla_x^2 v - 2te^{-t\alpha}\langle \nabla_x v, \nabla_x \alpha \rangle - tve^{-t\alpha}\nabla_x^2 \alpha \right] &= 0 \\ v_t + \frac{1}{2} \left[\nabla_x^2 v - 2t\langle \nabla_x v, \nabla_x \alpha \rangle - tv\nabla_x^2 \alpha \right] &= 0 \\ v_t + \frac{1}{2} \left[\nabla_x^2 v - 2t\langle \nabla_x \alpha, \nabla_x v \rangle - tv\nabla_x^2 \alpha \right] &= 0 \\ v_t + \frac{1}{2} \nabla_x^2 v + \langle -t\nabla_x \alpha, \nabla_x v \rangle - \frac{1}{2}tv\nabla_x^2 \alpha &= 0 \end{aligned} \quad (3.3.12)$$

Let $\sigma(t, x) = \mathbb{I}_d$, i.e. the uniform identity function. Let $\mu(t, x) = -t\nabla_x \alpha$ for $t \in [0, T]$, $x \in \mathbb{R}^d$, and for fixed α . Let $f(t, x, v) = -\frac{1}{2}tv\nabla_x^2 \alpha$ for $t \in [0, T]$, $x \in \mathbb{R}^d$.

Claim 3.3.3. *It is the case that for for all $x \in \mathbb{R}^d$ and $t \in [0, T]$ that $\langle x, \mu(t, x) \rangle \leq L(1 + \|x\|_E)$ for some constant $L \in (0, \infty)$.*

Proof. Since α has bounded first and second derivatives let:

$$\mathfrak{B} = \max \left\{ \sup_{x \in \mathbb{R}^d} \|\nabla_x \alpha\|_E, \sup_{x \in \mathbb{R}^d} |\nabla_x^2 \alpha| \right\} \quad (3.3.13)$$

Note that we then have the Cauchy-Schwarz inequality:

$$\begin{aligned}
\langle x, \mu(t, x) \rangle &\leq \| \langle x, -t \nabla_x \alpha \rangle \|_E \leq \|x\|_E \|t \nabla_x \alpha\|_E \\
&\leq T (\|x\|_E \mathfrak{B}) \\
&\leq T (\mathfrak{B} + d) \|x\|_E \\
&= L \|x\|_E \leq L (1 + \|x\|_E^2)
\end{aligned} \tag{3.3.14}$$

It also follows that $\|\sigma(t, x)\|_F = \sqrt{d} \leq L \leq L(1 + \|x\|_E)$. \square

Claim 3.3.4. *It is the case that for all $x, y \in \mathbb{R}^d$, and $t \in [0, T]$ that: $\|\mu(t, x) - \mu(t, y)\|_E + \|\sigma(t, x) - \sigma(t, y)\|_E \leq \mathfrak{C} (\|x\|_E + \|y\|_E) (\|x - y\|_E)$ for some constant $\mathfrak{C} \in (0, \infty)$.*

Proof. The fact that for all $x, y \in \mathbb{R}^d$ and $t \in [0, T]$ it is the case that $\|\sigma(t, x) - \sigma(t, y)\|_F = 0$, the fact that for all $x, y \in \mathbb{R}^d$ it is the case that $(\|x\|_E + \|y\|_E)(\|x - y\|_E) \geq 0$ and (3.3.13) tells us that:

$$\begin{aligned}
\|\mu(t, x) - \mu(t, y)\|_E + \|\sigma(t, x) - \sigma(t, y)\|_F &= \|\mu(t, x) - \mu(t, y)\|_E + 0 \\
&= \|t \nabla_x \alpha(x) - t \nabla_x \alpha(y)\|_E \\
&\leq T \|\nabla_x \alpha(x) - \nabla_x \alpha(y)\|_E \\
&\leq 2T \mathfrak{B}
\end{aligned} \tag{3.3.15}$$

Now consider a function $\mathfrak{f} \in C([0, T] \times \mathbb{R}^d, \mathbb{R}^d)$, where for all $x, y \in \mathbb{R}^d$ it is the case that $\mathfrak{f}(x) - \mathfrak{f}(y) \leq \mathcal{C} (\|x\|_E + \|y\|_E) (\|x - y\|_E)$. Note then that setting $y = x + h$ gives us:

$$\begin{aligned}
\left| \frac{\mathfrak{f}(x+h) - \mathfrak{f}(x)}{h} \right| &\leq \mathcal{C} (\|x\|_E + \|x+h\|_E) \\
\lim_{h \rightarrow 0} \left| \frac{\mathfrak{f}(x+h) - \mathfrak{f}(x)}{h} \right| &\leq \lim_{h \rightarrow 0} \mathcal{C} (\|x\|_E + \|x+h\|_E) \\
|\nabla_x \mathfrak{f}(x)| &\leq 2\mathcal{C} \|x\|_E = \mathcal{X} \|x\|_E
\end{aligned} \tag{3.3.16}$$

This suggests that $\nabla_x \mathfrak{f} \in O(x)$ and in particular that $\mathfrak{f} \in O(x^2)$. However with $\mathfrak{f} \curvearrowright \mu$ we first notice that because $\mu \leq 2T \mathfrak{B}$ in (3.3.15) it must also be the case that $\mu \in O(1)$ by Corollary 1.2.30.1. However since $O(c) \subseteq O(x) \subseteq O(x^2)$ by Corollary 1.2.30.2 it is also the case that $\mu \in O(x^2)$, and

hence there exists a \mathfrak{C} satisfying the claim. This proves the claim. \square

Claim 3.3.5. *It is the case that $|f(t, x, v) - f(t, x, w)| \leq L|v - w|$*

Proof. Note that by the absolute homogeneity property of norms, we have:

$$\begin{aligned}
|f(t, x, v) - f(t, x, w)| &= \left| \frac{1}{2}tv\nabla_x^2\alpha - \frac{1}{2}tw\nabla_x^2\alpha \right| \\
&= \left| \frac{1}{2}t\nabla_x^2\alpha \right| |v - w| \\
&\leq \frac{1}{2}T |\nabla_x^2\alpha| |v - w| \\
&\leq \frac{1}{2}T\mathfrak{B} |v - w| \\
&\leq T(\mathfrak{B} + d) |v - w| \\
&= L |v - w|
\end{aligned} \tag{3.3.17}$$

\square

Note that we may rewrite (3.3.12) as:

$$\begin{aligned}
\left(\frac{\partial}{\partial t} v \right) (t, x) + \frac{1}{2} \text{Trace} (\sigma (t, x) [\sigma (t, x)]^* (\text{Hess}_x v) (t, x)) + \langle \mu (t, x), (\nabla_x v) (t, x) \rangle \\
+ f (t, x, v (t, x)) = 0
\end{aligned}$$

We realize that (3.3.12) is a case of (Beck et al., 2021c, Corollary 3.9) where it is the case that: $u(t, x) \curvearrowright v(t, x)$, where $\sigma_d(x) = \mathbb{I}_d$ for all $x \in \mathbb{R}^d$, $d \in \mathbb{N}$, where $\mu(t, x) = -t\nabla_x\alpha$ for fixed α and for all $t \in [0, T]$, $x \in \mathbb{R}^d$, and where $f(t, x, u(t, x)) = -\frac{1}{2}tu\nabla_x^2\alpha$ for fixed α and for all $t \in [0, T]$, $x \in \mathbb{R}^d$.

We thus have that there exists a unique, at most polynomially growing viscosity solution $v \in C([0, T] \times \mathbb{R}^d, \mathbb{R})$ given as:

$$v(t, x) = \mathbb{E} \left[v \left(T, \mathcal{Y}_T^{t,x} \right) + \int_t^T f \left(s, \mathcal{Y}_s^{t,x}, v \left(s, \mathcal{Y}_s^{t,x} \right) \right) ds \right] \tag{3.3.18}$$

Let $\mathcal{V} : [0, T] \times \Omega \rightarrow \mathbb{R}^m$ be a standard $(\mathbb{F}_t)_{t \in [0, T]}$ -Brownian motion. Note that this also implies

that the \mathcal{Y} in (3.3.18) is characterized as:

$$\mathcal{Y}_s^{t,x} = x + \int_t^s \mu(r, \mathcal{Y}_r^{t,x}) dr + \int_t^s \sigma(s, \mathcal{X}_r^{t,x}) d\mathcal{V}_r \quad (3.3.19)$$

With substitution, this is then:

$$\begin{aligned} \mathcal{Y}_s^{t,x} &= x + \int_t^s -r \nabla_x \alpha(\mathcal{Y}_r^{t,x}) dr + \int_t^s \mathbb{I} d\mathcal{V}_r \\ \mathcal{Y}_s^{t,x} &= x - \int_t^s r \nabla_x \alpha(\mathcal{Y}_s^{t,x}) dr + \mathcal{V}_{s-t} \end{aligned}$$

Note that our initial substitution tells us: $v(t, x) = e^{t\alpha(x)} u(t, x)$. And so we have that:

$$\begin{aligned} v(t, x) &= \mathbb{E} \left[v \left(T, \mathcal{X}_T^{t,x} \right) + \int_t^T f \left(s, \mathcal{X}_s^{t,x}, v \left(s, \mathcal{X}_s^{t,x} \right) \right) ds \right] \quad (3.3.20) \\ v(t, x) &= \mathbb{E} \left[v \left(T, \mathcal{X}_T^{t,x} \right) - \frac{1}{2} \int_t^T tv \left(s, \mathcal{X}_s^{t,x} \right) \nabla_x^2 \alpha \left(\mathcal{X}_s^{t,x} \right) ds \right] \\ e^{t\alpha(x)} u(t, x) &= \mathbb{E} \left[\exp \left[T\alpha \left(\mathcal{X}_T^{t,x} \right) \right] u \left(T, \mathcal{X}_T^{t,x} \right) - \frac{1}{2} \int_t^T t \exp \left[t\alpha \left(\mathcal{X}_s^{t,x} \right) \right] u \left(t, \mathcal{X}_s^{t,x} \right) \nabla_x^2 \alpha \left(\mathcal{X}_s^{t,x} \right) ds \right] \\ u(t, x) &= \mathbb{E} \left[\exp \left[T\alpha \left(\mathcal{X}_T^{t,x} \right) - t\alpha(x) \right] u \left(T, \mathcal{X}_T^{t,x} \right) \right] \\ &\quad - \mathbb{E} \left[\frac{1}{2e^{t\alpha(x)}} \int_t^T t \exp \left[t\alpha \left(\mathcal{X}_s^{t,x} \right) \right] u \left(t, \mathcal{X}_s^{t,x} \right) \nabla_x^2 \alpha \left(\mathcal{X}_s^{t,x} \right) ds \right] \end{aligned}$$

□

Chapter 4

Brownian motion Monte Carlo of the non-linear case

We now seek to apply the techniques introduced in Chapter 2 on ???. To do so we need a variation of Setting 4.0.1. To that end we define such a setting. Assume v, f, α from Lemma 3.3.2.

Definition 4.0.1 (Subsequent Setting). *Let $g \in C(\mathbb{R}^d, \mathbb{R})$ be the function defined by:*

$$g(x) = v(T, x) \tag{4.0.1}$$

Let $F : C([0, T] \times \mathbb{R}^d, \mathbb{R}) \rightarrow C([, T] \times \mathbb{R}^d, \mathbb{R})$ be the functional defined as:

$$(F(v))(t, x) = f(t, x, v(t, x)) \tag{4.0.2}$$

Note also that by Claim 3.3.5 it is the case that:

$$|f(t, x, w) - f(t, x, \mathfrak{w})| \leq L |w - \mathfrak{w}| \tag{4.0.3}$$

Note also that since $f(t, x, 0) = 0$, and since by (Beck et al., 2021a, Corollary 3.9), v is growing at most polynomially, it is then the case that:

$$\max\{|f(t, x, 0)|, |g(x)|\} \leq \mathfrak{L}(1 + \|x\|^p) \tag{4.0.4}$$

Substituting (4.0.1) and (4.0.2) into (3.3.20) renders (3.3.20) as:

$$\begin{aligned}
v(t, x) &= \mathbb{E} \left[v \left(T, \mathcal{X}_T^{t,x} \right) + \int_t^T f \left(s, \mathcal{X}_s^{t,x}, v \left(s, \mathcal{X}_s^{t,x} \right) \right) ds \right] \\
v(t, x) &= \mathbb{E} \left[v \left(T, \mathcal{X}_T^{t,x} \right) \right] + \mathbb{E} \left[\int_t^T f \left(s, \mathcal{X}_s^{t,x}, v \left(s, \mathcal{X}_s^{t,x} \right) \right) ds \right] \\
v(t, x) &= \mathbb{E} \left[v \left(T, \mathcal{X}_T^{t,x} \right) \right] + \int_t^T \mathbb{E} \left[f \left(s, \mathcal{X}_s^{t,x}, v \left(s, \mathcal{X}_s^{t,x} \right) \right) ds \right] \\
v(t, x) &= \mathbb{E} \left[g \left(\mathcal{X}_T^{t,x} \right) \right] + \int_t^T \mathbb{E} \left[(F(v)) \left(s, \mathcal{X}_s^{t,x} \right) \right] ds
\end{aligned}$$

Let $d, m \in \mathbb{N}$, $T, \mathfrak{L}, p \in [0, \infty)$, $\mathfrak{p} \in [2, \infty)$ $\mathfrak{m} = \mathfrak{k}_p \sqrt{\mathfrak{p} - 1}$, $\Theta = \bigcup_{n \in \mathbb{N}} \mathbb{Z}^n$, $f \in C([0, T] \times \mathbb{R}^d \times \mathbb{R})$, $g \in C(\mathbb{R}^d, \mathbb{R})$, let $F : C([0, T] \times \mathbb{R}^d, \mathbb{R}) \rightarrow C([0, T] \times \mathbb{R}^d, \mathbb{R})$ assume for all $t \in [0, T]$, $x \in \mathbb{R}^d$ that:

$$|f(t, x, w) - f(t, x, \mathfrak{w})| \leq L |w - \mathfrak{w}| \quad \max \{ |f(t, x, 0)|, |g(x)| \} \leq \mathfrak{L} (1 + \|x\|_E^2) \quad (4.0.5)$$

and let $(\Omega, \mathcal{F}, \mathbb{P})$ be a probability space, let $\mathbf{u}^\theta : \Omega \rightarrow [0, 1]$, $\theta \in \Theta$ be i.i.d. random variables, and assume for all $\theta \in \Theta$, $r \in (0, 1)$ that $\mathbb{P}(\mathbf{u}^\theta \leq r) = r$, let $\mathcal{U}^\theta : [0, T] \times \Omega \rightarrow [0, T]$, $\theta \in \Theta$ satisfy for all $t \in [0, T]$, $\theta \in \Theta$ that $\mathcal{U}_t^\theta = t + (T - t) \mathbf{u}^\theta$, let $\mathcal{W}^\theta : [0, T] \times \Omega \rightarrow \mathbb{R}^d$, $\theta \in \Theta$ be independent standard Brownian motions, let $u \in C([0, T] \times \mathbb{R}^d, \mathbb{R})$ satisfy for all $t \in [0, T]$, $x \in \mathbb{R}^d$, that $\mathbb{E} \left[|g(x + \mathcal{W}_{T-t}^0)| \right] + \int_t^T \mathbb{E} \left[(F(u)) \left(s, x + \mathcal{W}_{s-t}^0 \right) \right] < \infty$ and:

$$u(t, x) = \mathbb{E} \left[g \left(x + \mathcal{W}_{T-t}^0 \right) \right] + \int_t^T \mathbb{E} \left[(F(u)) \left(s, x + \mathcal{W}_{s-t}^0 \right) \right] ds \quad (4.0.6)$$

and let let $U^\theta : [0, T] \times \mathbb{R}^d \times \Omega \rightarrow \mathbb{R}$, $\theta \in \Theta$, $n \in \mathbb{Z}$ satisfy for all $\theta \in \Theta$, $t \in [0, T]$, $x \in \mathbb{R}^d$, $n \in \mathbb{N}_0$ that:

$$\begin{aligned}
U_n^\theta(t, x) &= \frac{\mathbb{1}_{\mathbb{N}}(n)}{m^n} \left[\sum_{k=1}^{m^n} g \left(x + \mathcal{W}_{T-t}^{(\theta, 0, -k)} \right) \right] \\
&\quad + \sum_{i=1}^{n-1} \frac{T-t}{m^{n-i}} \left[\sum_{k=1}^{m^{n-i}} \left(F \left(U_i^{(\theta, i, k)} \right) \right) \left(\mathcal{U}^{(\theta, i, k)}, x + \mathcal{W}_{\mathcal{U}_t^{(\theta, i, k)}}^{(\theta, i, k)} \right) \right]
\end{aligned} \quad (4.0.7)$$

Part II

A Structural Description of Artificial Neural Networks

Chapter 5

Introduction and Basic Notions

About Neural Networks

We seek here to introduce a unified framework for artificial neural networks. This framework borrows from the work presented in [Grohs et al. \(2018\)](#) and work done by Joshua Padgett, Benno Kuckuk, and Arnulf Jentzen (unpublished). With this framework in place, we wish to study ANNs from the perspective of trying to see the number of parameters required to define a neural network to solve certain PDEs. The *curse of dimensionality* here refers to the number of parameters necessary to model PDEs and their growth (exponential or otherwise) as dimensions d increase.

5.1 The Basic Definition of ANNs and instantiations of ANNs

Definition 5.1.1 (Rectifier Function). *Let $d \in \mathbb{N}$ and $x \in \mathbb{R}^d$. We denote by $\tau : \mathbb{R} \rightarrow \mathbb{R}$ the function given by:*

$$\tau(x) = \max\{0, x\} \tag{5.1.1}$$

Definition 5.1.2 (Artificial Neural Networks). *Denote by NN the set given by:*

$$\text{NN} = \bigcup_{L \in \mathbb{N}} \bigcup_{l_0, l_1, \dots, l_L \in \mathbb{N}} \left(\prod_{k=1}^L \left[\mathbb{R}^{l_k \times l_{k-1}} \times \mathbb{R}^{l_k} \right] \right) \tag{5.1.2}$$

An artificial neural network is a tuple $(\nu, P, D, I, O, H, L, W)$ where $\nu \in \text{NN}$ and is equipped with the following functions (referred to as auxiliary functions) satisfying for all $\nu \in \left(\prod_{k=1}^L [\mathbb{R}^{l_k \times l_{k-1}} \times \mathbb{R}^{l_k}]\right)$:

(i) $P : \text{NN} \rightarrow \mathbb{N}$ denoting the number of parameters of ν , given by:

$$P(\nu) = \sum_{k=1}^L l_k (l_{k-1} + 1) \quad (5.1.3)$$

(ii) $D : \text{NN} \rightarrow \mathbb{N}$ denoting the number of layers of ν other than the input layer given by:

$$D(\nu) = L \quad (5.1.4)$$

(iii) $I : \text{NN} \rightarrow \mathbb{N}$ denoting the width of the input layer, given by:

$$I(\nu) = l_0 \quad (5.1.5)$$

(iv) $O : \text{NN} \rightarrow \mathbb{N}$ denoting the width of the output layer, given by:

$$O(\nu) = l_L \quad (5.1.6)$$

(v) $H : \text{NN} \rightarrow \mathbb{N}_0$ denoting the number of hidden layers (i.e., layers other than the input and output), given by:

$$H(\nu) = L - 1 \quad (5.1.7)$$

(vi) $L : \text{NN} \rightarrow \bigcup_{L \in \mathbb{N}} \mathbb{N}^L$ denoting the width of layers as an $(L + 1)$ -tuple, given by:

$$L(\nu) = (l_0, l_1, l_2, \dots, l_L) \quad (5.1.8)$$

We sometimes refer to this as the layer configuration or layer architecture of ν .

(vii) $W_i : \text{NN} \rightarrow \mathbb{N}_0$ denoting the width of layer i , given by:

$$W_i(\nu) = \begin{cases} l_i & i \leq L \\ 0 & i > L \end{cases} \quad (5.1.9)$$

Note that this implies that $\nu = ((W_1, b_1), (W_2, b_2), \dots, (W_L, b_L)) \in \left(\times_{k=1}^L [\mathbb{R}^{l_k \times l_{k-1}} \times \mathbb{R}^{l_k}] \right)$. Note that we also denote by $\text{Weight}_{(\cdot), \nu} : (\text{Weight}_{n, \nu})_{n \in \{1, 2, \dots, L\}} : \{1, 2, \dots, L\} \rightarrow \left(\bigcup_{m, k \in \mathbb{N}} \mathbb{R}^{m \times k} \right)$ and also $\text{Bias}_{(\cdot), \nu} : (\text{Bias}_{n, \nu})_{\{1, 2, \dots, L\}} : \{1, 2, \dots, L\} \rightarrow \left(\bigcup_{m \in \mathbb{N}} \mathbb{R}^m \right)$ the functions that satisfy for all $n \in \{1, 2, \dots, L\}$ that $\text{Weight}_{i, \nu} = W_i$ i.e. the weights matrix for neural network ν at layer i and $\text{Bias}_{i, \nu} = b_i$, i.e. the bias vector for neural network ν at layer i .

We will call l_0 the *starting width* and l_L the *finishing width*. Together, they will be referred to as *end-widths*.

Remark 5.1.3. Notice that our definition varies somewhat from the conventional ones found in [Petersen and Voigtlaender \(2018\)](#) and [Grohs et al. \(2023\)](#) in that whereas the former talk about auxiliary functions as existing within the set NN we will talk about these auxiliary functions as something elements of NN are endowed with. In other words, elements of NN may exist whose depths and parameter counts, for instance, are undefined and non-determinate.

Note that we develop this definition to closely align to popular deep-learning frameworks such as **PyTorch**, **TensorFlow**, and **Flux**, where, in principle, it is always possible to know the parameter count, depth, number of layers, and other auxiliary information.

We will often say let $\nu \in \text{NN}$, and it is implied that the tuple ν with the auxiliary functions is what is being referred to.

Definition 5.1.4 (Instantiations of Artificial Neural Networks with Activation Functions). Let $\mathbf{a} \in C(\mathbb{R}, \mathbb{R})$, we denote by $\mathfrak{J}_{\mathbf{a}} : \text{NN} \rightarrow \left(\bigcup_{k, l \in \mathbb{N}} C(\mathbb{R}^k, \mathbb{R}^l) \right)$ the function satisfying for all $L \in \mathbb{N}$, $l_0, l_1, \dots, l_L \in \mathbb{N}$, $\nu = ((W_1, b_1), (W_2, b_2), \dots, (W_L, b_L)) \in \left(\times_{k=1}^L [\mathbb{R}^{l_k \times l_{k-1}} \times \mathbb{R}^{l_k}] \right)$, $x_0 \in \mathbb{R}^{l_0}, x_1 \in \mathbb{R}^{l_1}, \dots, x_{L-1} \in \mathbb{R}^{l_{L-1}}$ and with $\forall k \in \mathbb{N} \cap (0, L) : x_k = \mathbf{a} \left([W_k x_k + b_k]_{*,*} \right)$ such that:

$$\mathfrak{J}_{\mathbf{a}}(\nu) \in C(\mathbb{R}^{l_0}, \mathbb{R}^{l_L}) \text{ and} \quad (\mathfrak{J}_{\mathbf{a}}(\nu))(x_0) = W_L x_{L-1} + b_L \quad (5.1.10)$$

We will often denote the instantiated neural network ν^{l_0, l_L} taking \mathbb{R}^{l_0} to \mathbb{R}^{l_L} as $\nu^{l_0, l_L} : \mathbb{R}^{l_0} \rightarrow \mathbb{R}^{l_L}$

or simply as $\mathbb{R}^{l_0} \xrightarrow{\nu} \mathbb{R}^{l_L}$ where l_0 and l_L are obvious.

A neural network ν with $\mathbf{L}(\nu) = (4, 5, 4, 2)$

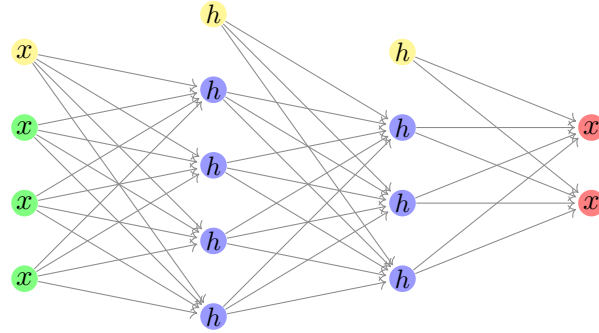

Remark 5.1.5. For an R implementation see Listings 10.1, 10.2, 10.3, and 10.4

Lemma 5.1.6. Let $\nu \in \text{NN}$, it is then the case that:

(i) $\mathbf{L}(\nu) \in \mathbb{N}^{\mathbf{D}(\nu)+1}$, and

(ii) for all $\mathbf{a} \in C(\mathbb{R}, \mathbb{R})$, $\mathfrak{J}_{\mathbf{a}} \in C(\mathbb{R}^{\mathbf{l}(\nu)}, \mathbb{R}^{\mathbf{O}(\nu)})$

Proof. By assumption:

$$\nu \in \text{NN} = \bigcup_{L \in \mathbb{N}} \bigcup_{(l_0, l_1, \dots, l_L) \in \mathbb{N}^{L+1}} \left(\prod_{k=1}^L \left[\mathbb{R}^{l_k \times l_{k-1}} \times \mathbb{R}^{l_k} \right] \right) \quad (5.1.11)$$

This ensures that there exist $l_0, l_1, \dots, l_L, L \in \mathbb{N}$ such that:

$$\nu \in \left(\prod_{j=1}^L \left[\mathbb{R}^{l_j \times l_{j-1}} \times \mathbb{R}^{B_j} \right] \right) \quad (5.1.12)$$

This also ensures that $\mathbf{L}(\nu) = (l_0, l_1, \dots, l_L) \in \mathbb{N}^{L+1} = \mathbb{N}^{\mathbf{D}(\nu)+1}$ and further that $\mathbf{l}(\nu) = l_0$, $\mathbf{O}(\nu) = l_L$, and that $\mathbf{D}(\nu) = L$. Together with (5.1.10), this proves the lemma. \square

5.2 Compositions of ANNs

The first operation we want to be able to do is to compose neural networks. Note that the composition is not done in an obvious way; for instance, note that the last layer of the first component of the composition is superimposed with the first layer of the second component of the composition.

5.2.1 Composition

Definition 5.2.1 (Compositions of ANNs). We denote by $(\cdot) \bullet (\cdot) : \{(\nu_1, \nu_2) \in \mathbb{NN} \times \mathbb{NN} : l(\nu_1) = O(\nu_1)\} \rightarrow \mathbb{NN}$ the function satisfying for all $L, M \in \mathbb{N}, l_0, l_1, \dots, l_L, m_0, m_1, \dots, m_M \in \mathbb{N}, \nu_1 = ((W_1, b_1), (W_2, b_2), \dots, (W_L, b_L)) \in \left(\times_{k=1}^L [\mathbb{R}^{l_k \times l_{k-1}} \times \mathbb{R}^{l_k}]\right)$, and $\nu_2 = ((W'_1, b'_1), (W'_2, b'_2), \dots, (W'_M, b'_M)) \in \left(\times_{k=1}^M [\mathbb{R}^{m_k \times m_{k-1}} \times \mathbb{R}^{m_k}]\right)$ with $l_0 = l(\nu_1) = O(\nu_2) = m_M$ and :

$$\nu_1 \bullet \nu_2 = \begin{cases} ((W'_1, b'_1), (W'_2, b'_2), \dots, (W'_{M-1}, b'_{M-1}), (W_1 W'_M, W_1 b'_M + b_1), (W_2, b_2), \\ \dots, (W_L, b_L)) & : (L > 1) \wedge (M > 1) \\ ((W_1 W'_1, W_1 b'_1 + b_1), (W_2, b_2), (W_3, b_3), \dots, (W_L, b_L)) & : (L > 1) \wedge (M = 1) \\ ((W'_1, b'_1), (W'_2, b'_2), \dots, (W'_{M-1}, b'_{M-1}), (W_1, b'_M + b_1)) & : (L = 1) \wedge (M > 1) \\ ((W_1 W'_1, W_1 b'_1 + b_1)) & : (L = 1) \wedge (M = 1) \end{cases} \quad (5.2.1)$$

Remark 5.2.2. For an R implementation see Listing 10.7

Lemma 5.2.3. Let $\nu, \mu \in \mathbb{NN}$ be such that $O(\mu) = l(\nu)$. It is then the case that:

(i) $D(\nu \bullet \mu) = D(\nu) + D(\mu) - 1$

(ii) For all $i \in \{1, 2, \dots, D(\nu \bullet \mu)\}$ that:

$$\begin{aligned} & \left(\text{Weight}_{i, (\nu \bullet \mu)}, \text{Bias}_{i, (\nu \bullet \mu)} \right) \\ &= \begin{cases} \left(\text{Weight}_{i, \mu}, \text{Bias}_{i, \mu} \right) & : i < D(\mu) \\ \left(\text{Weight}_{1, \nu} \text{Weight}_{D(\mu), \mu}, \text{Weight}_{1, \nu} \text{Bias}_{D(\mu), \mu} + \text{Bias}_{1, \nu} \right) & : i = D(\mu) \\ \left(\text{Weight}_{i - D(\mu) + 1, \nu} \text{Bias}_{i - D(\mu) + 1, \nu} \right) & : i > D(\mu) \end{cases} \end{aligned}$$

Proof. This is a consequence of (5.2.1), which implies both (i) and (ii). \square

Lemma 5.2.4. Let $\nu_1, \nu_2, \nu_3 \in \mathbb{NN}$ satisfy that $l(\nu_1) = O(\nu_2)$ and $l(\nu_2) = O(\nu_3)$, it is then the case

that:

$$(\nu_1 \bullet \nu_2) \bullet \nu_3 = \nu_1 \bullet (\nu_2 \bullet \nu_3) \quad (5.2.2)$$

Proof. This is a consequence of (Grohs et al., 2023, Lemma 2.8) with $\Phi_1 \curvearrowright \nu_1$, $\Phi_2 \curvearrowright \nu_2$, and $\Phi_3 \curvearrowright \nu_3$, and the functions $\mathcal{I} \curvearrowright \mathsf{I}$, $\mathcal{L} \curvearrowright \mathsf{D}$ and $\mathcal{O} \curvearrowright \mathsf{O}$. \square

The following Lemma will be important later on, referenced numerous times, and found in (Grohs et al., 2023, Proposition 2.6). For completion, we will include a simplified version of the proof here.

Lemma 5.2.5. *Let $\nu_1, \nu_2 \in \mathbb{NN}$. Let it also be that $\mathsf{O}(\nu_1) = \mathsf{I}(\nu_2)$. It is then the case that:*

$$(i) \quad \mathsf{D}(\nu_1 \bullet \nu_2) = \mathsf{D}(\nu_1) + \mathsf{D}(\nu_2) - 1$$

$$(ii) \quad \mathsf{L}(\nu_1 \bullet \nu_2) = (\mathsf{W}_1(\nu_2), \mathsf{W}_2(\nu_2), \dots, \mathsf{W}_{\mathsf{H}(\nu_2)}(\nu_2), \mathsf{W}_1(\nu_1), \mathsf{W}_2(\nu_1), \dots, \mathsf{W}_{\mathsf{D}(\phi_1)}(\nu_1))$$

$$(iii) \quad \mathsf{H}(\nu_1 \bullet \nu_2) = \mathsf{H}(\nu_1) + \mathsf{H}(\nu_2)$$

$$(iv) \quad \mathsf{P}(\nu_1 \bullet \nu_2) \leq \mathsf{P}(\nu_1) + \mathsf{P}(\nu_2) + \mathsf{W}_1(\nu_1) \cdot \mathsf{W}_{\mathsf{H}(\nu_2)}(\nu_2)$$

(v) *for all $\mathfrak{a} \in C(\mathbb{R}, \mathbb{R})$ that $\mathfrak{J}_{\mathfrak{a}}(\nu_1 \bullet \nu_2)(x) \in C(\mathbb{R}^{\mathsf{I}(\nu_2)}, \mathbb{R}^{\mathsf{O}(\nu_1)})$ and further:*

$$\mathfrak{J}_{\mathfrak{a}}(\nu_1 \bullet \nu_2) = [\mathfrak{J}_{\mathfrak{a}}(\nu_1)] \circ [\mathfrak{J}_{\mathfrak{a}}(\nu_2)] \quad (5.2.3)$$

Proof. Note that Items (i)---(iii) are a simple consequence of Definition 5.2.1. Specifically, given neural networks $\nu_1, \nu_2 \in \mathbb{NN}$, and $\mathsf{D}(\nu_1) = n$ and $\mathsf{D}(\nu_2) = m$, note that for all four cases, we have that the depth of the composed neural network $\nu_1 \bullet \nu_2$ is given by $n - 1 + m - 1 = n + m - 1$ proving Item (i). Note that the outer neural network loses its last layer, yielding Item (ii) in all four cases. Finally since, for all $\nu \in \mathbb{NN}$ it is the case that $\mathsf{H}(\nu) = \mathsf{D}(\nu) - 1$, Item (i) yields Item (iii).

Now, suppose it is the case that $\nu_3 = \nu_1 \bullet \nu_2$ and that:

$$\nu_1 = ((W_{1,1}, b_{1,1}), (W_{1,2}, b_{1,2}), \dots, (W_{1,L_1}, b_{1,L_1}))$$

$$\nu_2 = ((W_{2,1}, b_{2,1}), (W_{2,2}, b_{2,2}), \dots, (W_{2,L_2}, b_{2,L_2}))$$

$$\nu_3 = ((W_{3,1}, b_{3,1}), (W_{3,2}, b_{3,2}), \dots, (W_{3,L_2}, b_{3,L_2}))$$

$$(5.2.4)$$

And that:

$$\begin{aligned}
\mathbf{L}(\nu_1) &= (l_{1,1}, l_{1,2}, \dots, l_{1,L_1}) \\
\mathbf{L}(\nu_2) &= (l_{2,1}, l_{2,2}, \dots, l_{2,L_2}) \\
\mathbf{L}(\nu_1 \bullet \nu_2) &= (l_{3,1}, l_{3,2}, \dots, l_{3,L_3})
\end{aligned} \tag{5.2.5}$$

and further let $x_0 \in \mathbb{R}^{l_{2,0}}, x_1 \in \mathbb{R}^{l_{2,1}}, \dots, x_{L_2-1} \in \mathbb{R}^{l_{2,L_2-1}}$ satisfy the condition that:

$$\forall k \in \mathbb{N} \cap (0, L_2) : x_k = \mathbf{a} \left([W_{2,k}x_{k-1} + b_{2,k}]_{*,*} \right) \tag{5.2.6}$$

also let $y_0 \in \mathbb{R}^{l_{1,0}}, y_1 \in \mathbb{R}^{l_{1,1}}, \dots, y_{L_1-1} \in \mathbb{R}^{l_{1,L_1-1}}$ satisfy:

$$\forall k \in \mathbb{N} \cap (0, L_1) : y_k = \mathbf{a} \left([W_{1,k}y_{k-1} + b_{1,k}]_{*,*} \right) \tag{5.2.7}$$

and finally let $z_0 \in \mathbb{R}^{l_{3,0}}, z_1 \in \mathbb{R}^{l_{3,1}}, \dots, z_{L_3-1} \in \mathbb{R}^{l_{3,L_3-1}}$ satisfy:

$$\forall k \in \mathbb{N} \cap (0, L_3) : z_k = \mathbf{a} \left([W_{3,k}z_{k-1} + b_{3,k}]_{*,*} \right) \tag{5.2.8}$$

Note then that by Item (i) of Definition 5.1.2 we have that:

$$\begin{aligned}
P(\nu_1 \bullet \nu_2) &= \sum_{k=1}^{L_3} l_{3,k} (l_{3,k-1} + 1) \\
&= \left[\sum_{k=1}^{L_2-1} l_{3,k} (l_{3,k-1} + 1) \right] + l_{3,L_2} (l_{3,L_2-1} + 1) + \left[\sum_{k=L_2+1}^{L_3} l_{3,k} (l_{3,k-1} + 1) \right] \\
&= \left[\sum_{k=1}^{L_2-1} l_{2,j} (l_{2,j-1} + 1) \right] + l_{1,1} (l_{2,L_2-1} + 1) + \left[\sum_{k=L_2+1}^{L_3} l_{j-L_2+1} (l_{1,j-L_2} + 1) \right] \\
&= \left[\sum_{k=1}^{L_2-1} l_{2,j} (l_{2,k-1} + 1) \right] + \left[\sum_{k=2}^{L_1} l_{1,j} (l_{1,k-1} + 1) \right] + l_{1,1} (l_{2,L_2-1} + 1) \\
&= \left[\sum_{k=1}^{L_2} l_{2,k} (l_{2,k-1} + 1) \right] + \left[\sum_{k=1}^{L_1} l_{1,k} (l_{1,k-1} + 1) \right] + l_{1,1} (l_{2,L_2-1} + 1) \\
&\quad - l_{2,L_2} (l_{2,L_2-1} + 1) - l_{1,1} (l_{1,0} + 1) \\
&= P(\nu_1) + P(\nu_2) + l_{1,1} \cdot l_{2,L_2-1}
\end{aligned} \tag{5.2.9}$$

Thus establishing Item (iv). Note by Definition 5.2.1, and the fact that $\mathbf{a} \in C(\mathbb{R}, \mathbb{R})$ it is the case that

$$\mathfrak{J}_{\mathbf{a}}(\nu_1 \bullet \nu_2) \in C\left(\mathbb{R}^{l(\nu_1)}, \mathbb{R}^{o(\nu_2)}\right) \tag{5.2.10}$$

Next note that by definition, it is the case that:

$$\mathbf{L}(\nu_1 \bullet \nu_2) = (l_{2,0}, l_{2,1}, \dots, l_{2,L_2-1}, l_{1,1}, l_{1,2}, \dots, l_{1,L_1}) \tag{5.2.11}$$

And further that:

$$\begin{aligned}
\forall k \in \mathbb{N} \cap (0, L_2) : (W_{3,k}, b_{3,k}) &= (W_{2,k}, b_{2,k}) \\
(W_{3,L_2}, b_{3,L_2}) &= (W_{1,1} \cdot W_{2,L_2}, W_{1,1} b_{2,L_2} + b_{1,1}) \\
\text{and } \forall k \in \mathbb{N} \cap (L_2, L_1 + L_2) : (W_{3,k}, b_{3,k}) &= (W_{1,j+1-L_2}, b_{1,j+1-L_2})
\end{aligned} \tag{5.2.12}$$

Since for all $k \in \mathbb{N} \cap [0, L_2)$ it is the case that $z_j = x_j$ and the fact that $y_0 = W_{2,L_2} x_{L_2-1} + b_{2,L_2}$

ensures us that:

$$\begin{aligned}
W_{3,L_2}z_{L_2-1} + b_{3,L_2} &= W_{3,L_2}x_{L_2-1} + b_{3,L_2} \\
&= W_{1,1}W_{2,L_2}x_{L_2-1} + W_{1,1}b_{2,L_2} + b_{1,1} \\
&= W_{1,1}(W_{2,L_2}x_{L_2-1} + b_{2,L_2}) + b_{1,1} = W_{1,1}y_0 + b_{1,1}
\end{aligned} \tag{5.2.13}$$

We next claim that for all $k \in \mathbb{N} \cap [L_2, L_1 + L_2)$ it is the case that:

$$W_{3,k}z_{k-1} + b_{3,k} = W_{1,k+1-L_2}y_{k-L_2} + b_{1,k+1-L_2} \tag{5.2.14}$$

This can be proved via induction on $k \in \mathbb{N} \cap [L_2, L_1 + L_2)$. Consider that our base case of $k = L_2$ in (5.2.14) is fulfilled by (5.2.13). Now note that for all $k \in \mathbb{N} \cap [L_2, \infty) \cap (0, L_1 + L_2 - 1)$ with:

$$W_{3,k}z_{k-1} + b_{3,k} = W_{1,k+1-L_2}y_{k-L_2} + b_{1,k+1-L_2} \tag{5.2.15}$$

it holds that:

$$\begin{aligned}
W_{3,k+1}z_k + b_{3,k+1} &= W_{3,k+1} \left([W_{3,k}z_{k-1} + b_{3,k}]_{*,*} \right) + b_{3,k+1} \\
&= W_{1,k+2-L_2} ([W_{1,k+1-L_2}y_{k-L_2}] + b_{1,k+1-L_2}) + b_{1,k+2-L_2} \\
&= W_{1,k+2-L_2}y_{k+1-L_2} + b_{1,k+2-L_2}
\end{aligned} \tag{5.2.16}$$

Whence induction proves (5.2.14). This, along with the fact that $L_3 = L_1 + L_2 - 1$ then indicates that:

$$W_{3,L_3}z_{L_3-1} + b_{3,L_3} = W_{3,L_1+L_2-1}z_{L_1+L_2-2} + b_{3,L_1+L_2-1} = W_{1,L_1}y_{L_1-1} + b_{1,L_1} \tag{5.2.17}$$

Finally, the fact that $\nu_3 = \nu_1 \bullet \nu_2$, in addition with (5.2.6), (5.2.7), and (5.2.8) then tells us that:

$$\begin{aligned}
[\mathfrak{J}_a(\nu_1 \bullet \nu_2)](x_0) &= [\mathfrak{J}_a(\nu_3)](x_0) = [\mathfrak{J}_a(\nu_3)](z_0) = W_{3,L_3} z_{L_3-1} + b_{3,L_3} \\
&= W_{1,L_1} y_{L_1-1} + b_{1,L_1} = [\mathfrak{J}_a(\nu_1)](y_0) \\
&= [\mathfrak{J}_a(\nu_1)]\left([W_{2,L_2} x_{L_2-1} + b_{2,L_2}]_{*,*}\right) \\
&= [\mathfrak{J}_a(\nu_1)]([\mathfrak{J}_a(\nu_2)](x_0)) = [\mathfrak{J}_a(\nu_1)] \circ [\mathfrak{J}_a(\nu_2)](x_0) \tag{5.2.18}
\end{aligned}$$

This and (5.2.10) then prove Item (v), hence proving the lemma. \square

5.3 Stacking of ANNs of Equal Depth

Definition 5.3.1 (Stacking of ANNs of same depth). *Let $L, n \in \mathbb{N}$, and let $\nu_1, \nu_2, \dots, \nu_n \in \text{NN}$, such that $D(\nu_1) = D(\nu_2) = \dots = D(\nu_n) = L$. As such, for all $i \in \{1, \dots, n\}$, let it also be the case that $L(\nu_i) = ((W_1^i, b_1^i), (W_2^i, b_2^i), \dots, (W_L^i, b_L^i))$. We then denote by $\boxplus_{i=1}^n \nu_i$, the neural network whose layer architecture is given by:*

$$\begin{aligned}
L(\boxplus_{i=1}^n \nu_i) &= ((\text{diag}(W_1^1, W_1^2, \dots, W_1^n), b_1^1 \frown b_1^2, \frown \dots \frown b_1^n), \\
&\quad (\text{diag}(W_2^1, W_2^2, \dots, W_2^n), b_2^1 \frown b_2^2, \frown \dots \frown b_2^n), \\
&\quad \vdots \\
&\quad (\text{diag}(W_L^1, W_L^2, \dots, W_L^n), b_L^1 \frown b_L^2, \frown \dots \frown b_L^n))
\end{aligned}$$

Remark 5.3.2. *For an R implementation see Listing ??*

Lemma 5.3.3. *Let $\nu_1, \nu_2 \in \text{NN}$, with $D(\nu_1) = D(\nu_2)$, $x_1 \in \mathbb{R}^{m_1}$, $x_2 \in \mathbb{R}^{m_2}$, and $\mathfrak{x} \in \mathbb{R}^{m_1+m_2}$. Let $\mathfrak{J}_\tau(\nu_1) : \mathbb{R}^{m_1} \rightarrow \mathbb{R}^{n_1}$, and $\mathfrak{J}_\tau : \mathbb{R}^{m_2} \rightarrow \mathbb{R}^{n_2}$. It is then the case that $\mathfrak{J}_\tau(\nu_1 \boxplus \nu_2)(\mathfrak{x}) = \mathfrak{J}_\tau(\nu_1)(x_1) \frown \mathfrak{J}_\tau(\nu_2)(x_2)$.*

Proof. Let $L(\nu_1) = ((W_1, b_1), (W_2, b_2), \dots, (W_L, b_L))$ and $L(\nu_2) = ((\mathfrak{W}_1, \mathfrak{b}_1), (\mathfrak{W}_2, \mathfrak{b}_2), \dots, (\mathfrak{W}_L, \mathfrak{b}_L))$,

and as such it is the case according to Definition 5.3.1 that:

$$\begin{aligned} \mathbf{L}(\nu_1 \boxplus \nu_2) &= ((\text{diag}(W_1, \mathfrak{W}_1), b_1 \frown \mathfrak{b}_1), \\ &\quad (\text{diag}(W_2, \mathfrak{W}_2), b_2 \frown \mathfrak{b}_2), \\ &\quad \vdots \\ &\quad (\text{diag}(W_L, \mathfrak{W}_L), b_L^1 \frown \mathfrak{b}_L)) \end{aligned}$$

Note that for all, $\mathbf{a} \in (\mathbb{R}, \mathbb{R})$, $j \in \{1, 2, \dots, L-1\}$ and for all $x \in \mathbb{R}^{\text{columns}(W_j) + \text{columns}(\mathfrak{W}_j)}$, $x_1 \in \mathbb{R}^{\text{columns}(W_j)}$, $x_2 \in \mathbb{R}^{\text{columns}(\mathfrak{W}_j)}$, $y \in \mathbb{R}^{\text{rows}(W_j) + \text{rows}(\mathfrak{W}_j)}$, $y_1 \in \mathbb{R}^{\text{rows}(W_j)}$, $y_2 \in \mathbb{R}^{\text{rows}(\mathfrak{W}_j)}$, where $y_1 = \mathbf{a} \left([W_j \cdot x_1 + b_1]_{*,*} \right)$, $y_2 = \mathbf{a} \left([\mathfrak{W}_j \cdot x_2 + \mathfrak{b}_j]_{*,*} \right)$, $y = \mathbf{a} \left([\text{diag}(W_j, \mathfrak{W}_j) \cdot x + (b_j \frown \mathfrak{b}_j)]_{*,*} \right)$ it is the case that, Corollary 1.2.34.1 tells us that:

$$\begin{aligned} y &= \mathbf{a} \left([\text{diag}(W_j, \mathfrak{W}_j) \cdot x + (b_j \frown \mathfrak{b}_j)]_{*,*} \right) = \mathbf{a} \left([(W_j \cdot x_1 + b_j) \frown (\mathfrak{W}_j \cdot x_2 + \mathfrak{b}_j)]_{*,*} \right) \\ &= \mathbf{a} \left([W_j \cdot x_1 + b_j]_{*,*} \right) \frown \mathbf{a} \left([\mathfrak{W}_j \cdot x_2 + \mathfrak{b}_j]_{*,*} \right) \\ &= y_1 \frown y_2 \end{aligned} \tag{5.3.1}$$

Note that this is repeated from one layer to the next, yielding that $\mathfrak{J}_\tau(\nu_1 \boxplus \nu_2)(\mathfrak{r}) = \mathfrak{J}_\tau(\nu_1)(x_1) \frown \mathfrak{J}_\tau(\nu_2)(x_2)$. \square

Remark 5.3.4. Given $n, L \in \mathbb{N}$, $\nu_1, \nu_2, \dots, \nu_n \in \mathbb{NN}$ such that $L = D(\nu_1) = D(\nu_2) = \dots = D(\nu_n)$ it is then the case, as seen from (??) that:

$$\boxplus_{i=1}^n \nu_i \in \left(\bigtimes_{k=1}^L \left[\mathbb{R}^{(\sum_{j=1}^n \mathfrak{W}_k(\nu_j)) \times (\sum_{j=1}^n \mathfrak{W}_{k-1}(\nu_j))} \times \mathbb{R}^{(\sum_{j=1}^n \mathfrak{W}_k(\nu_j))} \right] \right) \tag{5.3.2}$$

Lemma 5.3.5. Let $n, L \in \mathbb{N}$, $\nu_1, \nu_2, \dots, \nu_n \in \mathbb{NN}$ satisfy that $L = D(\nu_1) = D(\nu_2) = \dots = D(\nu_n)$. It is then the case that:

$$\mathbf{P}([\boxplus_{i=1}^n \nu_i]) \leq \frac{1}{2} \left[\sum_{i=1}^n \mathbf{P}(\nu_i) \right]^2 \tag{5.3.3}$$

Proof. Note that by Remark 5.5.2 we have that:

$$\begin{aligned}
\mathbb{P}(\boxplus_{i=1}^n \nu_i) &= \sum_{k=1}^L \left[\sum_{i=1}^n l_{i,k} \right] \left[\left(\sum_{i=1}^n l_{i,k-1} \right) + 1 \right] \\
&= \sum_{k=1}^L \left[\sum_{i=1}^n l_{i,k} \right] \left[\left(\sum_{j=1}^n l_{j,k-1} \right) + 1 \right] \\
&\leq \sum_{i=1}^n \sum_{j=1}^n \sum_{k=1}^L l_{i,k} (l_{j,k-1} + 1) \\
&\leq \sum_{i=1}^n \sum_{j=1}^n \sum_{\ell=1}^L l_{i,k} (l_{j,\ell-1} + 1) \\
&= \sum_{i=1}^n \sum_{j=1}^n \left[\sum_{k=1}^L l_{i,k} \right] \left[\sum_{\ell=1}^L (l_{j,\ell-1} + 1) \right] \\
&\leq \sum_{i=1}^n \sum_{j=1}^n \left[\sum_{k=1}^L \frac{1}{2} l_{i,k} (l_{i,k-1} + 1) \right] \left[\sum_{\ell=1}^L l_{j,\ell} (l_{j,\ell-1} + 1) \right] \\
&= \sum_{i=1}^n \sum_{j=1}^n \frac{1}{2} \mathbb{P}(\nu_i) \mathbb{P}(\nu_j) = \frac{1}{2} \left[\sum_{i=1}^n \mathbb{P}(\nu_i) \right]^2
\end{aligned} \tag{5.3.4}$$

This completes the proof of the lemma. \square

Corollary 5.3.5.1. *Let $n \in \mathbb{N}$. Let $\nu_1, \nu_2, \dots, \nu_n \in \text{NN}$ satisfy that $\mathbf{L}(\nu_1) = \mathbf{L}(\nu_2) = \dots = \mathbf{L}(\nu_n)$. It is then the case that:*

$$\mathbb{P}(\boxplus_{i=1}^n \nu_i) \leq n^2 \mathbb{P}(\nu_1) \tag{5.3.5}$$

Proof. Since it is the case that for all $j \in \{1, 2, \dots, n\}$ that: $\mathbf{L}(\nu_j) = (l_0, l_1, \dots, l_L)$, where $l_0, l_1, \dots, l_L, L \in \mathbb{N}$, we may say that:

$$\begin{aligned}
\mathbb{P}(\boxplus_{j=1}^n \nu_j) &= \sum_{j=1}^L (nl_j) [(nl_{j-1}) + 1] \leq \sum_{j=1}^L (nl_j) [(nl_{j-1}) + n] \\
&= n^2 \left[\sum_{j=1}^L l_j (l_{j-1} + 1) \right] = n^2 \mathbb{P}(\nu_1)
\end{aligned} \tag{5.3.6}$$

\square

Lemma 5.3.6. *Let $\nu_1, \nu_2 \in \mathbb{NN}$, such that $D(\nu_1) = D(\nu_2) = L$. It is then the case that $P(\nu_1) + P(\nu_2) \leq P(\nu_1 \boxplus \nu_2)$.*

Proof. Remark 5.3.4 tells us that:

$$\nu_1 \boxplus \nu_2 \in \left(\prod_{k=1}^L \left[\mathbb{R}^{(W_k(\nu_1) + W_k(\nu_2)) \times (W_{k-1}(\nu_1) + W_{k-1}(\nu_2))} \times \mathbb{R}^{W_k(\nu_1) + W_k(\nu_2)} \right] \right) \quad (5.3.7)$$

The definition of $P()$ from Definition 5.1.2, and the fact that $W_i \geq 1$ for all $i \in \{1, 2, \dots, L\}$ tells us then that:

$$\begin{aligned} P(\nu_1 \boxplus \nu_2) &= \sum_{k=1}^L [(W_k(\nu_1) + W_k(\nu_2)) \times (W_{k-1}(\nu_1) + W_{k-1}(\nu_2) + 1)] \\ &= \sum_{k=1}^L [W_k(\nu_1) W_{k-1}(\nu_1) + W_k(\nu_1) W_{k-1}(\nu_2) \\ &\quad + W_k(\nu_1) + W_k(\nu_2) W_{k-1}(\nu_1) + W_k(\nu_2) W_{k-1}(\nu_2) + W_k(\nu_2)] \\ &\geq \sum_{k=1}^L [W_k(\nu_1) W_{k-1}(\nu_1) + W_k(\nu_1) + W_k(\nu_2) W_{k-1}(\nu_2) + W_k(\nu_2)] \\ &= \sum_{k=1}^L [W_k(\nu_1) (W_{k-1}(\nu_1) + 1)] + \sum_{k=1}^L [W_k(\nu_2) (W_{k-1}(\nu_2) + 1)] \\ &= P(\nu_1) + P(\nu_2) \end{aligned} \quad (5.3.8)$$

□

Corollary 5.3.6.1. *Let $\nu_1, \nu_2, \nu_3 \in \mathbb{NN}$. Let $P(\nu_2) \leq P(\nu_3)$. It is then the case that $P(\nu_1 \boxplus \nu_2) \leq P(\nu_1 \boxplus \nu_3)$.*

Proof. Lemma 5.3.6 tells us that:

$$0 \leq P(\nu_1) + P(\nu_3) \leq P(\nu_1 \boxplus \nu_3) \quad (5.3.9)$$

$$0 \leq P(\nu_1) + P(\nu_2) \leq P(\nu_1 \boxplus \nu_2) \quad (5.3.10)$$

Subtracting (5.3.9) from (5.3.10) gives us that:

$$\begin{aligned} 0 &\leq \mathbf{P}(\nu_3) - \mathbf{P}(\nu_2) \leq \mathbf{P}(\nu_1 \boxplus \nu_3) - \mathbf{P}(\nu_1 \boxplus \nu_2) \\ &\mathbf{P}(\nu_1 \boxplus \nu_2) \leq \mathbf{P}(\nu_1 \boxplus \nu_2) \end{aligned}$$

□

Lemma 5.3.7. *Let $m_1, m_2, n_1, n_2 \in \mathbb{N}$. Let $\nu_1, \nu_2 \in \mathbb{NN}$, such that $\mathfrak{J}_\tau(\nu_1) \in C(\mathbb{R}^{m_1}, \mathbb{R}^{n_1})$ and $\mathfrak{J}_\tau(\nu_2) \in C(\mathbb{R}^{m_2}, \mathbb{R}^{n_2})$. It is then the case that $(\mathfrak{J}_\alpha(\nu_1 \boxplus \nu_2)) \left(\begin{bmatrix} x \\ x' \end{bmatrix} \right) = (\mathfrak{J}_\alpha(\nu_2 \boxplus \nu_1)) \left(\begin{bmatrix} x' \\ x \end{bmatrix} \right)$ for $x \in \mathbb{R}^{m_1}, x' \in \mathbb{R}^{n_1}$, upto transposition.*

Proof. Note that this is a consequence of the commutativity of summation in the exponents of (5.3.2), and the fact that switching ν_1 and ν_2 with a transposition results in a transposed output for transposed input. □

Lemma 5.3.8. *Let $\mathbf{a} \in C(\mathbb{R}, \mathbb{R})$, $n \in \mathbb{N}$, and $\nu = \boxplus_{i=1}^n \nu_i$ satisfy the condition that $\mathbf{D}(\nu_1) = \mathbf{D}(\nu_2) = \dots = \mathbf{D}(\nu_n)$. It is then the case that $\mathfrak{J}_\alpha(\nu) \in C\left(\mathbb{R}^{\sum_{i=1}^n l(\nu_i)}, \mathbb{R}^{\sum_{i=1}^n o(\nu_i)}\right)$*

Proof. Let $L = \mathbf{D}(\nu_1)$, and let $l_{i,0}, l_{i,1}, \dots, l_{i,L} \in \mathbb{N}$ satisfy for all $i \in \{1, 2, \dots, n\}$ that $\mathbf{L}(\nu_i) = (l_{i,0}, l_{i,1}, \dots, l_{i,L})$. Furthermore let $((W_{i,1}, b_{i,1}), (W_{i,2}, b_{i,2}), \dots, (W_{i,L}, b_{i,L})) \in \left(\times_{j=1}^L [\mathbb{R}^{l_{i,j} \times l_{i,j-1}} \times \mathbb{R}^{l_{i,j}}]\right)$ satisfy for all $i \in \{1, 2, \dots, n\}$ that:

$$\nu_i = ((W_{i,1}, b_{i,1}), (W_{i,2}, b_{i,2}), \dots, (W_{i,L}, b_{i,L})) \quad (5.3.11)$$

Let $\alpha_j \in \mathbb{N}$ with $j \in \{0, 1, \dots, L\}$ satisfy that $\alpha_j = \sum_{i=1}^n l_{i,j}$ and let $((A_1, b_1), (A_2, b_2), \dots, (A_L, b_L)) \in \left(\times_{j=1}^L [\mathbb{R}^{\alpha_j \times \alpha_{j-1}} \times \mathbb{R}^{\alpha_j}]\right)$ satisfy that:

$$\boxplus_{i=1}^n \nu_i = ((A_1, b_1), (A_2, b_2), \dots, (A_L, b_L)) \quad (5.3.12)$$

See Remark 5.3.2. Let $x_{i,0}, x_{i,1}, \dots, x_{i,L-1} \in (\mathbb{R}^{l_{i,0}} \times \mathbb{R}^{l_{i,1}} \times \dots \times \mathbb{R}^{l_{i,L-1}})$ satisfy for all $i \in \{1, 2, \dots, n\}$ $k \in \mathbb{N} \cap (0, L)$ that:

$$x_{i,j} = \text{Mult}_{\mathbf{a}}^{l_{i,j}} (W_{i,j} x_{i,j-1} + b_{i,j}) \quad (5.3.13)$$

Note that (5.3.12) demonstrates that $\mathbb{I}(\Xi_{i=1}^n \nu_i) = \alpha_0$ and $\mathbb{O}(\Xi_{i=1}^n \nu_i) = \alpha_L$. This and Item(ii) of Lemma 5.1.6, and the fact that for all $i \in \{1, 2, \dots, n\}$ it is the case that $\mathbb{I}(\nu_i) = l_{i,0}$ and $\mathbb{O}(\nu_i) = l_{i,L}$ ensures that:

$$\begin{aligned} \mathfrak{J}_a(\Xi_{i=1}^n) &\in C(\mathbb{R}^{\alpha_0}, \mathbb{R}^{\alpha_L}) = C\left(\mathbb{R}^{\sum_{i=1}^n l_{i,0}}, \mathbb{R}^{\sum_{i=1}^n l_{i,L}}\right) \\ &= C\left(\mathbb{R}^{\sum_{i=1}^n \mathbb{I}(\nu_i)}, \mathbb{R}^{\sum_{i=1}^n \mathbb{O}(\nu_i)}\right) \end{aligned}$$

This proves the lemma. □

5.4 Stacking of ANNs of Unequal Depth

We will often encounter neural networks that we want to stack but have unequal depth. Definition 5.3.1 only deals with neural networks of the same depth. We will facilitate this situation by introducing a form of "padding" for our neural network. Hence, they come out to the same length before stacking them. This padding will be via the "tunneling" neural network, as shown below.

Definition 5.4.1 (Identity Neural Network). *We will denote by $\text{Id}_d \in \text{NN}$ the neural network satisfying for all $d \in \mathbb{N}$ that:*

(i)

$$\text{Id}_1 = \left(\left(\begin{bmatrix} 1 \\ -1 \end{bmatrix}, \begin{bmatrix} 0 \\ 0 \end{bmatrix} \right) \left(\begin{bmatrix} 1 & -1 \end{bmatrix}, \begin{bmatrix} 0 \end{bmatrix} \right) \right) \in ((\mathbb{R}^{2 \times 1} \times \mathbb{R}^2) \times (\mathbb{R}^{1 \times 2} \times \mathbb{R}^1)) \quad (5.4.1)$$

(ii)

$$\text{Id}_d = \Xi_{i=1}^d \text{Id}_1 \quad (5.4.2)$$

For $d > 1$.

Remark 5.4.2. *We will discuss some properties of Id in Section 6.2.*

Definition 5.4.3 (The Tunneling Neural Network). *We define the tunneling neural network, de-*

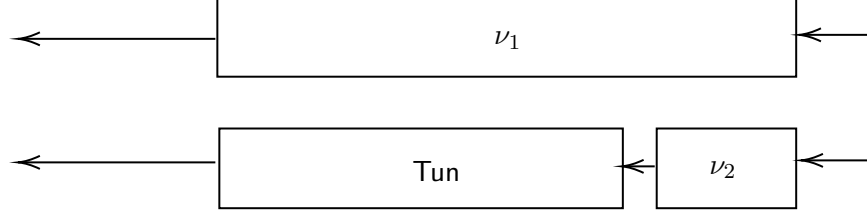

Figure 5.1: Diagrammatic representation of the stacking of unequal depth neural networks

noted as Tun_n for $n \in \mathbb{N}$ and $d \in \mathbb{N}$ by:

$$\text{Tun}_n^d = \begin{cases} \text{Aff}_{\mathbb{I}_d,0} & : n = 1 \\ \text{Id}_d & : n = 2 \\ \bullet^{n-2} \text{Id}_d & n \in \mathbb{N} \cap [3, \infty) \end{cases} \quad (5.4.3)$$

We will drop the requirement for d and Tun_n by itself will be used to denote Tun_n^1 .

Remark 5.4.4. We will discuss some properties of the Tun_n^d network in Section 6.2.

Definition 5.4.5. Let $n \in \mathbb{N}$, and $\nu_1, \nu_2, \dots, \nu_n \in \text{NN}$. We will define the stacking of unequal length neural networks, denoted $\diamond_{i=1}^n \nu_i$ as the neural network given by:

$$\diamond_{i=1}^n \nu_i = \boxminus_{i=1}^n [\text{Tun}_{\max_i \{D(\nu_i)\} + 1 - D(\nu_i)} \bullet \nu_i] \quad (5.4.4)$$

Diagrammatically, this can be thought of as:

Lemma 5.4.6. Let $\nu_1, \nu_2 \in \text{NN}$. It is then the case that:

$$P(\nu_1 \diamond \nu_2) \leq 2 \cdot (\max \{P(\nu_1), P(\nu_2)\})^2 \quad (5.4.5)$$

Proof. This is a straightforward consequence of Lemma 5.3.5. □

5.5 Affine Linear Transformations as ANNs and Their Properties.

Definition 5.5.1. Let $m, n \in \mathbb{N}$, $W \in \mathbb{R}^{m \times n}$, $b \in \mathbb{R}^m$. We denote by $\text{Aff}_{W,b} \in (\mathbb{R}^{m \times n} \times \mathbb{R}^m) \subseteq \text{NN}$ the neural network given by $\text{Aff}_{W,b} = ((W, b))$.

Lemma 5.5.2. *Let $m, n \in \mathbb{N}$, $W \in \mathbb{R}^{m \times n}$, $b \in \mathbb{R}^m$. It is then the case that:*

(i) $L(\text{Aff}_{W,b}) = (n, m) \in \mathbb{N}^2$.

(ii) for all $\mathbf{a} \in C(\mathbb{R}, \mathbb{R})$ it is the case that $\mathfrak{J}_{\mathbf{a}}(\text{Aff}_{W,b}) \in C(\mathbb{R}^n, \mathbb{R}^m)$

(iii) for all $\mathbf{a} \in C(\mathbb{R}, \mathbb{R})$, $x \in \mathbb{R}^n$ we have $(\mathfrak{J}_{\mathbf{a}}(\text{Aff}_{W,b}))(x) = Wx + b$

Proof. Note that (i) is a consequence of Definition 5.1.2 and 5.5.1. Note next that $\text{Aff}_{W,b} = (W, b) \in (\mathbb{R}^{m \times n} \times \mathbb{R}^m) \subseteq \text{NN}$. Note that (5.1.10) then tells us that $\mathfrak{J}_{\mathbf{a}}(\text{Aff}_{W,b}) = Wx + b$ which in turn proves (ii) and (iii) □

Remark 5.5.3. *Given $W \in \mathbb{R}^{m \times n}$, and $b \in \mathbb{R}^{m \times 1}$, it is the case that according to Definition (5.1.3) we have: $P(\text{Aff}_{W,b}) = m \times n + m$*

Remark 5.5.4. *For an R implementation see Listing ??*

Lemma 5.5.5. *Let $\nu \in \text{NN}$. It is then the case that:*

(i) For all $m \in \mathbb{N}$, $W \in \mathbb{R}^{m \times \mathcal{O}(\nu)}$

$$L(\text{Aff}_{W,B} \bullet \nu) = (W_0(\nu), W_1(\nu), \dots, W_{D(\nu)-1}(\nu), m) \in \mathbb{N}^{D(\nu)+1} \quad (5.5.1)$$

(ii) For all $\mathbf{a} \in C(\mathbb{R}, \mathbb{R})$, $m \in \mathbb{N}$, $W \in \mathbb{R}^{m \times \mathcal{O}(\nu)}$, $B \in \mathbb{R}^m$, we have that $\mathfrak{J}_{\mathbf{a}}(\text{Aff}_{W,B} \bullet \nu) \in C(\mathbb{R}^{I(\nu)}, \mathbb{R}^m)$.

(iii) For all $\mathbf{a} \in C(\mathbb{R}, \mathbb{R})$, $m \in \mathbb{N}$, $W \in \mathbb{R}^{m \times \mathcal{O}(\nu)}$, $B \in \mathbb{R}^m$, $x \in \mathbb{R}^{I(\nu)}$ that:

$$(\mathfrak{J}(\text{Aff}_{W,b} \bullet \nu))(x) = W(\mathfrak{J}_{\mathbf{a}}(\nu))(x) + b \quad (5.5.2)$$

(iv) For all $n \in \mathbb{N}$, $W \in \mathbb{R}^{I(\nu) \times n}$, $b \in \mathbb{R}^{I(\nu)}$ that:

$$L(\nu \bullet \text{Aff}_{W,b}) = (n, W_1(\nu), W_2(\nu), \dots, W_{D(\nu)}(\nu)) \in \mathbb{N}^{D(\nu)+1} \quad (5.5.3)$$

(v) For all $\mathbf{a} \in C(\mathbb{R}, \mathbb{R})$, $n \in \mathbb{N}$, $W \in \mathbb{R}^{I(\nu) \times n}$, $b \in \mathbb{R}^{I(\nu)}$ that $\mathfrak{J}_{\mathbf{a}}(\nu \bullet \text{Aff}_{W,b}) \in C(\mathbb{R}^n, \mathbb{R}^{\mathcal{O}(\nu)})$ and,

(vi) For all $\mathbf{a} \in C(\mathbb{R}, \mathbb{R})$, $n \in \mathbb{N}$, $W \in \mathbb{R}^{l(\nu) \times n}$, $b \in \mathbb{R}^{l(\nu)}$, $x \in \mathbb{R}^n$ that:

$$(\mathfrak{J}_{\mathbf{a}}(\nu \bullet \text{Aff}_{W,b}))(x) = (\mathfrak{J}_{\mathbf{a}}(\nu))(Wx + b) \quad (5.5.4)$$

Proof. From Lemma 5.5.2 we see that $\mathfrak{J}_{\mathbf{a}}(\text{Aff}_{W,b}) \in C(\mathbb{R}^n, \mathbb{R}^m)$ given by $\mathfrak{J}_{\mathbf{a}}(\text{Aff}_{W,b}) = Wx + b$. This and Lemma 5.2.5 prove (i) – (vi). \square

Corollary 5.5.5.1. Let $m, n \in \mathbb{N}$, and $W \in \mathbb{R}^{m \times n}$ and $b \in \mathbb{R}^m$. Let $\nu \in \text{NN}$. It is then the case that:

(i) for all $\text{Aff}_{W,b} \in \text{NN}$ with $l(\text{Aff}_{W,b}) = O(\nu)$ that:

$$P(\text{Aff}_{W,b} \bullet \nu) \leq \left[\max \left\{ 1, \frac{O(\text{Aff}_{W,b})}{l_L} \right\} \right] P(\nu) \quad (5.5.5)$$

(ii) for all $\text{Aff}_{W,b} \in \text{NN}$ with $O(\text{Aff}_{W,b}) = l(\nu)$ that:

$$P(\nu \bullet \text{Aff}_{W,b}) \leq \left[\max \left\{ 1, \frac{l(\text{Aff}_{W,b}) + 1}{l(\nu) + 1} \right\} \right] P(\nu) \quad (5.5.6)$$

Proof. Let it be the case that $l(\nu) = (l_0, l_1, \dots, l_L)$ for $l_0, l_1, \dots, l_L, L \in \mathbb{N}$. Lemma 5.5.5, Item (i), and Lemma 5.2.5 then tells us that:

$$\begin{aligned} P(\text{Aff}_{W,b} \bullet \nu) &= \left[\sum_{m=1}^{L-1} l_m (l_{m-1} + 1) \right] + O(\text{Aff}_{W,b}) (l_{L-1} + 1) \\ &= \left[\sum_{m=1}^{L-1} l_m (l_{m-1} + 1) \right] + \left[\frac{O(\text{Aff}_{W,b})}{l_L} \right] l_L (l_{L-1} + 1) \\ &\leq \left[\max \left\{ 1, \frac{O(\text{Aff}_{W,b})}{l_L} \right\} \right] \left[\sum_{m=1}^{L-1} l_m (l_{m-1} + 1) \right] + \left[\max \left\{ 1, \frac{O(\text{Aff}_{W,b})}{l_L} \right\} \right] l_L (l_{L-1} + 1) \\ &= \left[\max \left\{ 1, \frac{O(\text{Aff}_{W,b})}{l_L} \right\} \right] \left[\sum_{m=1}^L l_m (l_{m-1} + 1) \right] = \left[\max \left\{ 1, \frac{O(\text{Aff}_{W,b})}{l_L} \right\} \right] P(\nu) \end{aligned}$$

and further that:

$$\begin{aligned}
\mathbf{P}(\nu \bullet \text{Aff}_{W,b}) &= \left[\sum_{m=2}^L l_m (l_{m-1} + 1) \right] + l_1 (\mathbf{I}(\text{Aff}_{W,b}) + 1) \\
&= \left[\sum_{m=2}^L l_m (l_{m-1} + 1) \right] + \left[\frac{\mathbf{I}(\text{Aff}_{W,b}) + 1}{l_0 + 1} \right] l_1 (l_0 + 1) \\
&\leq \left[\max \left\{ 1, \frac{\mathbf{I}(\text{Aff}_{W,b}) + 1}{l_0 + 1} \right\} \right] \left[\sum_{m=2}^L l_m (l_{m-1} + 1) \right] + \left[\max \left\{ 1, \frac{\mathbf{I}(\text{Aff}_{W,b}) + 1}{l_0 + 1} \right\} \right] l_1 (l_0 + 1) \\
&= \left[\max \left\{ 1, \frac{\mathbf{I}(\text{Aff}_{W,b}) + 1}{l_0 + 1} \right\} \right] \left[\sum_{m=1}^L l_m (l_{m-1} + 1) \right] = \left[\max \left\{ 1, \frac{\mathbf{I}(\text{Aff}_{W,b}) + 1}{\mathbf{I}(\nu) + 1} \right\} \right] \mathbf{P}(\nu)
\end{aligned}$$

This completes the proof of the lemma. \square

Lemma 5.5.6. *Let $\mathbf{a}_1, \mathbf{a}_2$ be two affine neural networks as defined in Definition 5.5.1. It is then the case that $\mathbf{a}_1 \boxplus \mathbf{a}_2$ is also an affine neural network*

Proof. This follows straightforwardly from Definition 5.3.1, where, given that $\mathbf{a}_1 = ((W_1, b_1))$, and $\mathbf{a}_2 = ((W_2, b_2))$, their stackings is the neural network $((\text{diag}(W_1, W_2), b_1 \frown b_2))$, which is clearly an affine neural network. \square

5.6 Sums of ANNs of Same End-widths

Definition 5.6.1 (The Cpy Network). *We define the neural network, $\text{Cpy}_{n,k} \in \text{NN}$ for $n, k \in \mathbb{N}$ as the neural network given by:*

$$\text{Cpy}_{n,k} = \text{Aff}_{\underbrace{[\mathbb{I}_k \ \mathbb{I}_k \ \cdots \ \mathbb{I}_k]^T}_{n\text{-many}}, \mathbf{0}_{nk}} \tag{5.6.1}$$

Where k represents the dimensions of the vectors being copied and n is the number of copies of the vector being made.

Remark 5.6.2. *See Listing ??*

Lemma 5.6.3. *Let $n, k \in \mathbb{N}$ and let $\text{Cpy}_{n,k} \in \text{NN}$, it is then the case for all $n, k \in \mathbb{N}$ that:*

(i) $\mathbf{D}(\text{Cpy}_{n,k}) = 1$

$$(ii) \text{ P}(\text{Cpy}_{n,k}) = nk^2 + nk$$

Proof. Note that (i) is a consequence of Definition 5.5.1 and (ii) follows from the structure of $\text{Cpy}_{n,k}$. \square

Definition 5.6.4 (The Sum Network). *We define the neural network $\text{Sum}_{n,k}$ for $n, k \in \mathbb{N}$ as the neural network given by:*

$$\text{Sum}_{n,k} = \text{Aff}[\underbrace{\mathbb{I}_k \mathbb{I}_k \cdots \mathbb{I}_k}_{n\text{-many}}, \mathbf{0}_k] \quad (5.6.2)$$

Where k represents the dimensions of the vectors being added and n is the number of vectors being added.

Remark 5.6.5. *See again, Listing ??*

Lemma 5.6.6. *Let $n, k \in \mathbb{N}$ and $\text{Sum}_{n,k} \in \text{NN}$, it is then the case for all $n, k \in \mathbb{N}$ that:*

$$(i) \text{ D}(\text{Sum}_{n,k}) = 1$$

$$(ii) \text{ P}(\text{Sum}_{n,k}) = nk^2 + k$$

Proof. (i) is a consequence of Definition 5.5.1 and (ii) follows from the structure of $\text{Sum}_{n,k}$. \square

Definition 5.6.7 (Sum of ANNs of the same depth and same end widths). *Let $u, v \in \mathbb{Z}$ with $u \leq v$. Let $\nu_u, \nu_{u+1}, \dots, \nu_v \in \text{NN}$ satisfy for all $i \in \mathbb{N} \cap [u, v]$ that $\text{D}(\nu_i) = \text{D}(\nu_u)$, $\text{I}(\nu_i) = \text{I}(\nu_u)$, and $\text{O}(\nu_i) = \text{O}(\nu_u)$. We then denote by $\oplus_{i=u}^v \nu_i$ or alternatively $\nu_u \oplus \nu_{u+1} \oplus \dots \oplus \nu_v$ the neural network given by:*

$$\oplus_{i=u}^v \nu_i := \left(\text{Sum}_{v-u+1, \text{O}(\nu_2)} \bullet [\boxminus_{i=u}^v \nu_i] \bullet \text{Cpy}_{(v-u+1), \text{I}(\nu_1)} \right) \quad (5.6.3)$$

Remark 5.6.8. *For an R implementation, see Listing 10.9.*

5.6.1 Neural Network Sum Properties

Lemma 5.6.9. *Let $\nu_1, \nu_2 \in \text{NN}$ satisfy that $D(\nu_1) = D(\nu_2) = L$, $I(\nu_1) = I(\nu_2)$, and $O(\nu_1) = O(\nu_2)$, and $L(\nu_1) = (l_{1,1}, l_{1,2}, \dots, l_{1,L})$ and $L(\nu_2) = (l_{2,1}, l_{2,2}, \dots, l_{2,L})$ it is then the case that:*

$$\begin{aligned} P(\nu_1 \oplus \nu_2) &= P\left(\text{Aff}_{[\mathbb{I}_{O(\nu_2)} \mathbb{I}_{O(\nu_2)}], \mathbb{0}_{O(\nu_2)}} \bullet [\nu_1 \boxminus \nu_2] \bullet \text{Aff}_{[\mathbb{I}_{I(\nu_1)} \mathbb{I}_{I(\nu_1)}]^T, \mathbb{0}_{2 \cdot I(\nu_1)}}\right) \\ &\leq \frac{1}{2} (P(\nu_1) + P(\nu_2))^2 \end{aligned} \quad (5.6.4)$$

Proof. Note that by Lemma 5.3.5 we have that:

$$P(\nu_1 \boxminus \nu_2) = \frac{1}{2} (P(\nu_1) + P(\nu_2))^2 \quad (5.6.5)$$

Note also that since Cpy and Sum are affine neural networks, from Corollary 5.5.5.1 we get that:

$$\begin{aligned} P\left([\nu_1 \boxminus \nu_2] \bullet \text{Cpy}_{2, I(\nu_1)}\right) &\leq \max\left\{1, \frac{I(\nu_1) + 1}{2I(\nu_1) + 1}\right\} \frac{1}{2} (P(\nu_1) + P(\nu_2))^2 \\ &= \frac{1}{2} (P(\nu_1) + P(\nu_2))^2 \end{aligned} \quad (5.6.6)$$

and further that:

$$\begin{aligned} P\left(\text{Sum}_{2, O(\nu_1 \boxminus \nu_2)} \bullet [\nu_1 \boxminus \nu_2] \bullet \text{Cpy}_{2, I(\nu_1)}\right) &\leq \left[\max\left\{1, \frac{O(\text{Aff}_{W,b})}{2O(\nu_1)}\right\}\right] \frac{1}{2} (P(\nu_1) + P(\nu_2))^2 \\ &= \frac{1}{2} (P(\nu_1) + P(\nu_2))^2 \end{aligned} \quad (5.6.7)$$

□

Corollary 5.6.9.1. *Let $n \in \mathbb{N}$. Let $\nu_1, \nu_2, \dots, \nu_n \in \text{NN}$ satisfy that $L(\nu_1) = L(\nu_2) = \dots = L(\nu_n)$. It is then the case that:*

$$P\left(\bigoplus_{i=1}^n \nu_i\right) \leq n^2 P(\nu_1) \quad (5.6.8)$$

Proof. Let $L(\nu_1) = (l_0, l_1, \dots, l_L)$ where for all $i \in \{0, 1, \dots, L\}$ it is the case that $l_i, L \in \mathbb{N}$. Corollary

5.3.5.1 then tells us that:

$$\mathbb{P}(\boxplus_{i=1}^n \nu_i) \leq n^2 \mathbb{P}(\nu_i) \quad (5.6.9)$$

Then from Corollary 5.5.5.1, and (5.6.6) we get that:

$$\mathbb{P}\left([\boxplus_{i=1}^n \nu_i] \bullet \text{Cpy}_{2,l(\nu_1)}\right) \leq n^2 \mathbb{P}(\nu_1) \quad (5.6.10)$$

And further that:

$$\mathbb{P}\left(\text{Sum}_{2,\mathcal{O}(\boxplus_{i=1}^n \nu_i)} \bullet [\boxplus_{i=1}^n \nu_i] \bullet \text{Cpy}_{2,l(\nu_1)}\right) \leq n^2 \mathbb{P}(\nu_1) \quad (5.6.11)$$

□

Lemma 5.6.10. *Let $\nu_1, \nu_2 \in \text{NN}$ satisfy that $\text{D}(\nu_1) = \text{D}(\nu_2) = L$, $l(\nu_1) = l(\nu_2)$, and $\mathcal{O}(\nu_1) = \mathcal{O}(\nu_2)$, and $\mathbb{L}(\nu_1) = (l_{1,1}, l_{1,2}, \dots, l_{1,L})$ and $\mathbb{L}(\nu_2) = (l_{2,1}, l_{2,2}, \dots, l_{2,L})$ it is then the case that:*

$$\text{D}(\nu_1 \oplus \nu_2) = L \quad (5.6.12)$$

Proof. Note that $\text{D}(\text{Cpy}_{n,k}) = 1 = \text{D}(\text{Sum}_{n,k})$ for all $n, k \in \mathbb{N}$. Note also that $\text{D}(\nu_1 \boxplus \nu_2) = \text{D}(\nu_1) = \text{D}(\nu_2)$ and that for $\nu, \mu \in \text{NN}$ it is the case that $\text{D}(\nu \bullet \mu) = \text{D}(\nu) + \text{D}(\mu) - 1$. Thus:

$$\begin{aligned} \text{D}(\nu_1 \oplus \nu_1) &= \text{D}(\nu_1 \oplus \nu_2) = \text{D}\left(\text{Aff}_{[\mathbb{I}_{\mathcal{O}(\nu_2)} \mathbb{I}_{\mathcal{O}(\nu_2)}], \mathcal{O}_{\mathcal{O}(\nu_2)}} \bullet [\nu_1 \boxplus \nu_2] \bullet \text{Aff}_{[\mathbb{I}_{l(\nu_1)} \mathbb{I}_{l(\nu_1)}]^T, \mathcal{O}_{2,l(\nu_1)}}\right) \\ &= L \end{aligned}$$

□

Lemma 5.6.11. *Let $\nu_1, \nu_2 \in \text{NN}$, such that $\text{D}(\nu_1) = \text{D}(\nu_2) = L$, $l(\nu_1) = l(\nu_2) = l_0$, and $\mathcal{O}(\nu_1) = \mathcal{O}(\nu_2) = l_L$. It is then the case that $\mathfrak{J}(\nu_1 \oplus \nu_2) = \mathfrak{J}(\nu_2 \oplus \nu_1)$, i.e., the instantiated sum of ANNs of the same depth and same end widths is commutative.*

Proof. Let $\nu_1 = ((W_1, b_1), (W_2, b_2), \dots, (W_L, b_L))$ and let $\nu_2 = ((W'_1, b'_1), (W'_2, b'_2), \dots, (W'_L, b'_L))$. Note

that Definition 5.3.1 then tells us that:

$$\nu_1 \boxminus \nu_2 = \left(\left(\begin{bmatrix} W_1 & 0 \\ 0 & W'_1 \end{bmatrix}, \begin{bmatrix} b_1 \\ b'_1 \end{bmatrix} \right), \left(\begin{bmatrix} W_2 & 0 \\ 0 & W'_2 \end{bmatrix}, \begin{bmatrix} b_2 \\ b'_2 \end{bmatrix} \right), \dots, \left(\begin{bmatrix} W_L & 0 \\ 0 & W'_L \end{bmatrix}, \begin{bmatrix} b_L \\ b'_L \end{bmatrix} \right) \right)$$

Note also that by Claims ?? and ?? and Definition 5.5.1 we know that:

$$\text{Aff}_{[\mathbb{I}_{\mathbb{I}(\nu_2)} \ \mathbb{I}_{\mathbb{I}(\nu_2)}]^T, \mathbb{O}_{2\mathbb{I}(\nu_2),1}} = \left(\begin{bmatrix} \mathbb{I}_{\mathbb{I}(\nu_2)} \\ \mathbb{I}_{\mathbb{I}(\nu_2)} \end{bmatrix}, \mathbb{O}_{2\mathbb{I}(\nu_2),1} \right) \quad (5.6.13)$$

and:

$$\text{Aff}_{[\mathbb{I}_{\mathbb{O}(\nu_1)} \ \mathbb{I}_{\mathbb{O}(\nu_1)}], \mathbb{O}_{2\mathbb{O}(\nu_1),1}} = \left(\begin{bmatrix} \mathbb{I}_{\mathbb{O}(\nu_1)} \\ \mathbb{I}_{\mathbb{O}(\nu_1)} \end{bmatrix}, \mathbb{O}_{2\mathbb{O}(\nu_1),1} \right) \quad (5.6.14)$$

Applying Definition 5.2.1, specifically the second case, (5.6.3) and (??) yields that:

$$\begin{aligned} & [\nu_1 \boxminus \nu_2] \bullet \text{Aff}_{[\mathbb{I}_{\mathbb{I}(\nu_2)} \ \mathbb{I}_{\mathbb{I}(\nu_2)}]^T, \mathbb{O}_{2\mathbb{I}(\nu_2),1}} \\ &= \left(\left(\begin{bmatrix} W_1 & 0 \\ 0 & W'_1 \end{bmatrix}, \begin{bmatrix} b_1 \\ b'_1 \end{bmatrix} \right), \left(\begin{bmatrix} W_2 & 0 \\ 0 & W'_2 \end{bmatrix}, \begin{bmatrix} b_2 \\ b'_2 \end{bmatrix} \right), \dots, \left(\begin{bmatrix} W_L & 0 \\ 0 & W'_L \end{bmatrix}, \begin{bmatrix} b_L \\ b'_L \end{bmatrix} \right) \right) \\ &= \left(\left(\begin{bmatrix} W_1 \\ W'_1 \end{bmatrix}, \begin{bmatrix} b_1 \\ b'_1 \end{bmatrix} \right), \left(\begin{bmatrix} W_2 & 0 \\ 0 & W'_2 \end{bmatrix}, \begin{bmatrix} b_2 \\ b'_2 \end{bmatrix} \right), \dots, \left(\begin{bmatrix} W_L & 0 \\ 0 & W'_L \end{bmatrix}, \begin{bmatrix} b_L \\ b'_L \end{bmatrix} \right) \right) \end{aligned}$$

Applying Claim ?? and especially the third case of Definition 5.2.1 to to the above then gives us:

$$\begin{aligned} & \text{Aff}_{[\mathbb{I}_{\mathbb{O}(\nu_1)} \ \mathbb{I}_{\mathbb{O}(\nu_1)}],0} \bullet [\nu_1 \boxminus \nu_2] \bullet \text{Aff}_{[\mathbb{I}_{\mathbb{I}(\nu_2)} \ \mathbb{I}_{\mathbb{I}(\nu_2)}]^T,0} \\ &= \left(\left(\begin{bmatrix} W_1 \\ W'_1 \end{bmatrix}, \begin{bmatrix} B_1 \\ B'_1 \end{bmatrix} \right), \left(\begin{bmatrix} W_2 & 0 \\ 0 & W'_2 \end{bmatrix}, \begin{bmatrix} b_2 \\ b'_2 \end{bmatrix} \right), \dots, \left(\begin{bmatrix} \mathbb{I}_{\mathbb{O}(\nu_2)} \ \mathbb{I}_{\mathbb{O}(\nu_2)} \end{bmatrix}, \begin{bmatrix} W_L & 0 \\ 0 & W'_L \end{bmatrix}, \begin{bmatrix} \mathbb{I}_{\mathbb{O}(\nu_2)} \ \mathbb{I}_{\mathbb{O}(\nu_2)} \end{bmatrix}, \begin{bmatrix} b_L \\ b'_L \end{bmatrix} \right) \right) \\ &= \left(\left(\begin{bmatrix} W_1 \\ W'_1 \end{bmatrix}, \begin{bmatrix} b_1 \\ b'_1 \end{bmatrix} \right), \left(\begin{bmatrix} W_2 & 0 \\ 0 & W'_2 \end{bmatrix}, \begin{bmatrix} b_2 \\ b'_2 \end{bmatrix} \right), \dots, \left(\begin{bmatrix} W_L & W'_L \end{bmatrix}, b_L + b'_L \right) \right) \quad (5.6.15) \end{aligned}$$

Now note that:

$$\nu_2 \boxplus \nu_1 = \left(\left(\left[\begin{array}{cc} W'_1 & 0 \\ 0 & W_1 \end{array} \right], \left[\begin{array}{c} b'_1 \\ b_1 \end{array} \right] \right), \left(\left[\begin{array}{cc} W'_2 & 0 \\ 0 & W_2 \end{array} \right], \left[\begin{array}{c} b'_2 \\ b_2 \end{array} \right] \right), \dots, \right. \\ \left. \left(\left[\begin{array}{cc} W'_L & 0 \\ 0 & W_L \end{array} \right], \left[\begin{array}{c} b'_L \\ b_L \end{array} \right] \right) \right)$$

And thus:

$$\begin{aligned} & \text{Aff}_{[\mathbb{I}_{\mathbb{O}(\nu_2)} \mathbb{I}_{\mathbb{O}(\nu_2)}], 0} \bullet [\nu_2 \boxplus \nu_1] \bullet \text{Aff}_{[\mathbb{I}_{\mathbb{I}(\nu_1)} \mathbb{I}_{\mathbb{I}(\nu_1)}]^T, 0} \\ &= \left(\left(\left[\begin{array}{c} W'_1 \\ W_1 \end{array} \right], \left[\begin{array}{c} b'_1 \\ b_1 \end{array} \right] \right), \left(\left[\begin{array}{cc} W'_2 & 0 \\ 0 & W_2 \end{array} \right], \left[\begin{array}{c} b'_2 \\ b_2 \end{array} \right] \right), \dots, \left(\left[\begin{array}{cc} W'_L & W_L \end{array} \right], \left[\begin{array}{c} b'_L + b_L \end{array} \right] \right) \right) \end{aligned} \quad (5.6.16)$$

Let $x \in \mathbb{R}^{\mathbb{I}(\nu_1)}$, note then that:

$$\left[\begin{array}{c} W_1 \\ W'_1 \end{array} \right] x + \left[\begin{array}{c} b_1 \\ b'_1 \end{array} \right] = \left[\begin{array}{c} W_1 x + b_1 \\ W'_1 x + b'_1 \end{array} \right]$$

The full instantiation of (5.6.15) is then given by:

$$\mathfrak{J} \left(\left[\begin{array}{cc} W_L & W'_L \end{array} \right] \left[\begin{array}{c} W_{L-1}(\dots(W_2(W_1 x + b_1) + b_2) + \dots) + b_{L-1} \\ W'_{L-1}(\dots(W'_2(W'_1 x + b'_1) + b'_2) + \dots) + b'_{L-1} \end{array} \right] + b_L + b'_L \right) \quad (5.6.17)$$

The full instantiation of (5.6.16) is then given by:

$$\mathfrak{J} \left(\left[\begin{array}{cc} W'_L & W_L \end{array} \right] \left[\begin{array}{c} W'_{L-1}(\dots(W'_2(W'_1 x + b'_1) + b'_2) + \dots) + b'_{L-1} \\ W_{L-1}(\dots(W_2(W_1 x + b_1) + b_2) + \dots) + b_{L-1} \end{array} \right] + b_L + b'_L \right) \quad (5.6.18)$$

Since (5.6.27) and (5.6.18) are the same this proves that $\nu_1 \oplus \nu_2 = \nu_2 \oplus \nu_1$. \square

This is a special case of (Grohs et al., 2022, Lemma 3.28).

Lemma 5.6.12. *Let $l_0, l_1, \dots, l_L \in \mathbb{N}$. Let $\nu \in \text{NN}$ with $\mathbb{L}(\nu) = (l_0, l_1, \dots, l_L)$. There then exists a neural network $\text{Zr}_{l_0, l_1, \dots, l_L} \in \text{NN}$ such that $\mathfrak{J}(\nu \oplus \text{Zr}_{l_0, l_1, \dots, l_L}) = \mathfrak{J}(\text{Zr}_{l_0, l_1, \dots, l_L} \oplus \nu) = \nu$.*

Proof. Let $\nu = ((W_1, b_1), (W_2, b_2), \dots, (W_L, b_L))$, where $W_1 \in \mathbb{R}^{l_1 \times l_0}$, $b_1 \in \mathbb{R}^{l_1}$, $W_2 \in \mathbb{R}^{l_2 \times l_1}$, $b_2 \in \mathbb{R}^{l_2}$, ..., $W_L \in \mathbb{R}^{l_L \times l_{L-1}}$, $b_L \in \mathbb{R}^{l_L}$. Denote by $\text{Zr}_{l_0, l_1, \dots, l_L}$ the neural network which for all $l_0, l_1, \dots, l_L \in \mathbb{N}$ is given by:

$$\text{Zr}_{l_0, l_1, \dots, l_L} = ((\mathbb{0}_{l_1, l_0}, \mathbb{0}_{l_1}), (\mathbb{0}_{l_2, l_1}, \mathbb{0}_{l_2}), \dots, (\mathbb{0}_{l_L, l_{L-1}}, \mathbb{0}_{l_L})) \quad (5.6.19)$$

Thus, by (5.6.27), we have that:

$$\begin{aligned} \mathfrak{J}(\text{Zr}_{l_0, l_1, \dots, l_L} \oplus \nu) &= \begin{bmatrix} 0 & W_L \end{bmatrix} \begin{bmatrix} 0 \\ W_{L-1}(\dots(W_2(W_1x + b_1) + b_2) + \dots) + b_{L-1} \end{bmatrix} + b_L \\ &= W_L(W_{L-1}(\dots(W_2(W_1x + b_1) + b_2) + \dots) + b_{L-1}) + b_L \end{aligned} \quad (5.6.20)$$

$$\begin{aligned} \mathfrak{J}(\nu \oplus \text{Zr}_{l_0, l_1, \dots, l_L}) &= \begin{bmatrix} W_L & 0 \end{bmatrix} \begin{bmatrix} W_{L-1}(\dots(W_2(W_1x + b_1) + b_2) + \dots) + b_{L-1} \\ 0 \end{bmatrix} + b_L \\ &= W_L(W_{L-1}(\dots(W_2(W_1x + b_1) + b_2) + \dots) + b_{L-1}) + b_L \end{aligned} \quad (5.6.21)$$

And finally:

$$\mathfrak{J}(\nu) = W_L(W_{L-1}(\dots(W_2(W_1x + b_1) + b_2) + \dots) + b_{L-1}) + b_L \quad (5.6.22)$$

This completes the proof. \square

Lemma 5.6.13. *Given neural networks $\nu_1, \nu_2, \nu_3 \in \text{NN}$ with fixed depth L , fixed starting width of l_0 and fixed finishing width of l_L , it is then the case that $\mathfrak{J}((\nu_1 \oplus \nu_2) \oplus \nu_3) = \mathfrak{J}(\nu_1 \oplus (\nu_2 \oplus \nu_3))$, i.e. the instantiation with a continuous activation function of \oplus is associative.*

Proof. Let $\nu_1 = ((W_1^1, b_1^1), (W_2^1, b_2^1), \dots, (W_L^1, b_L^1))$, $\nu_2 = ((W_1^2, b_1^2), (W_2^2, b_2^2), \dots, (W_L^2, b_L^2))$, and $\nu_3 = ((W_1^3, b_1^3), (W_2^3, b_2^3), \dots, (W_L^3, b_L^3))$. Then (5.6.27) tells us that:

$$\mathfrak{J}(\nu_1 \oplus \nu_2) = \begin{bmatrix} W_L^1 & W_L^2 \end{bmatrix} \begin{bmatrix} W_{L-1}^1(\dots(W_2^1(W_1^1x + b_1^1) + b_2^1) + \dots) + b_{L-1}^1 \\ W_{L-1}^2(\dots(W_2^2(W_1^2x + b_1^2) + b_2^2) + \dots) + b_{L-1}^2 \end{bmatrix} + b_L^1 + b_L^2$$

And thus:

$$\begin{aligned} \mathfrak{J}((\nu_1 \oplus \nu_2) \oplus \nu_3)(x) = \\ \mathfrak{J} \left(\begin{bmatrix} \mathbb{I} & W_L^3 \end{bmatrix} \begin{bmatrix} W_L^1 & W_L^2 \end{bmatrix} \begin{bmatrix} W_{L-1}^1 (\dots (W_2^1 (W_1^1 x + b_1^1) + b_2^1) + \dots) + b_{L-1}^1 \\ W_{L-1}^2 (\dots (W_2^2 (W_1^2 x + b_1^2) + b_2^2) + \dots) + b_{L-1}^2 \\ W_{L-1}^3 (\dots (W_2^3 (W_1^3 x + b_1^3) + b_2^3) + \dots) + b_{L-1}^3 \end{bmatrix} + b_L^1 + b_L^2 \right) + b_L^3 \end{aligned} \quad (5.6.23)$$

Similarly, we have that:

$$\begin{aligned} \mathfrak{J}_a(\nu_1 \oplus (\nu_2 \oplus \nu_3))(x) = \\ \mathfrak{J} \left(\begin{bmatrix} W_L^1 & \mathbb{I} \end{bmatrix} \begin{bmatrix} W_L^2 & W_L^3 \end{bmatrix} \begin{bmatrix} W_{L-1}^1 (\dots (W_2^1 (W_1^1 x + b_1^1) + b_2^1) + \dots) + b_{L-1}^1 \\ W_{L-1}^2 (\dots (W_2^2 (W_1^2 x + b_1^2) + b_2^2) + \dots) + b_{L-1}^2 \\ W_{L-1}^3 (\dots (W_2^3 (W_1^3 x + b_1^3) + b_2^3) + \dots) + b_{L-1}^3 \end{bmatrix} + b_L^2 + b_L^3 \right) + b_L^1 \end{aligned} \quad (5.6.24)$$

Note that the associativity of matrix-vector multiplication ensures that (5.6.23) and (5.6.24) are the same. \square

Definition 5.6.14 (Commutative Semi-group). *A set X equipped with a binary operation $*$ is called a monoid if:*

(i) *for all $x, y, z \in X$ it is the case that $(x * y) * z = x * (y * z)$ and*

(ii) *for all $x, y \in X$ it is the case that $x * y = y * x$*

Theorem 5.6.15. *For fixed depth and layer widths, the set of instantiated neural networks $\nu \in \text{NN}$ form a commutative semi-group under the operation of \oplus .*

Proof. This is a consequence of Lemmas 5.6.11, 5.6.12, and 5.6.13. \square

Lemma 5.6.16. *Let $\nu, \mu \in \text{NN}$, with the same length and end-widths. It is then the case that $\mathfrak{J}_a(\nu \oplus \mu) = \mathfrak{J}_a(\nu) + \mathfrak{J}_a(\mu)$.*

Proof. Let $\nu = ((W_1, b_1), (W_2, b_2), \dots, (W_L, b_L))$ and $\mu = ((W'_1, b'_1), (W'_2, b'_2), \dots, (W'_L, b'_L))$. Note now that by (5.6.27) we have that:

$$\mathfrak{J}_a(\nu) = W_L \mathfrak{a}(W_{L-1}(\dots \mathfrak{a}(W_2 \mathfrak{a}(W_1 x + b_1) + b_2) + \dots) + b_{L-1}) + b_L \quad (5.6.25)$$

And:

$$\mathfrak{J}_a(\mu) = W'_L \mathfrak{a}(W'_{L-1}(\dots \mathfrak{a}(W'_2 \mathfrak{a}(W'_1 x + b'_1) + b'_2) + \dots) + b'_{L-1}) + b'_L \quad (5.6.26)$$

In addition, because of the block matrix structure of the weights of our summands:

$$\begin{aligned} \mathfrak{J}_a(\nu \oplus \mu)(x) &= \begin{bmatrix} W_L & W'_L \end{bmatrix} \begin{bmatrix} \mathfrak{a}(W_{L-1}(\dots \mathfrak{a}(W_2 \mathfrak{a}(W_1 x + b_1) + b_2) + \dots) + b_{L-1}) \\ \mathfrak{a}(W'_{L-1}(\dots \mathfrak{a}(W'_2 \mathfrak{a}(W'_1 x + b'_1) + b'_2) + \dots) + b'_{L-1}) \end{bmatrix} + b_L + b'_L \\ &= W_L \mathfrak{a}(W_{L-1}(\dots \mathfrak{a}(W_2 \mathfrak{a}(W_1 x + b_1) + b_2) + \dots) + b_{L-1}) + b_L \\ &\quad + W'_L \mathfrak{a}(W'_{L-1}(\dots \mathfrak{a}(W'_2 \mathfrak{a}(W'_1 x + b'_1) + b'_2) + \dots) + b'_{L-1}) + b'_L \\ &= \mathfrak{J}_a(\nu)(x) + \mathfrak{J}_a(\mu)(x) \end{aligned} \quad (5.6.27)$$

This proves the lemma. \square

Lemma 5.6.17. *Let $n \in \mathbb{N}$. Let $\nu_1, \nu_2, \dots, \nu_n \in \text{NN}$. It is then the case that:*

$$\mathfrak{J}_a\left(\bigoplus_{i=1}^n \nu_i\right) = \sum_{i=1}^n \mathfrak{J}_a(\nu_i) \quad (5.6.28)$$

Proof. This is the consequence of a finite number of applications of Lemma 5.6.16. \square

5.6.2 Sum of ANNs of Unequal Depth But Same End-widths

Definition 5.6.18 (Sum of ANNs of different depths but same end widths). *Let $n \in \mathbb{N}$. Let $\nu_1, \nu_2, \dots, \nu_n \in \text{NN}$ such that they have the same end widths. We define the neural network $\diamond_{i=1}^n \nu_i \in \text{NN}$, the neural network sum of neural networks of unequal depth as:*

$$\diamond_{i=1}^n \nu_i := \left(\text{Sum}_{n, \text{O}(\nu_2)} \bullet \left[\diamond_{i=u}^v \nu_i \right] \bullet \text{Cpy}_{n, \text{l}(\nu_1)} \right) \quad (5.6.29)$$

Lemma 5.6.19. *Let $n \in \mathbb{N}$. Let $\nu_1, \nu_2 \in \text{NN}$ and assume also that they have the same end-widths. It is then the case that:*

$$\mathfrak{J}_\tau(\nu_1 \diamond \nu_2)(x) = \mathfrak{J}_\tau(\nu_1) + \mathfrak{J}_\tau(\nu_2) \quad (5.6.30)$$

Proof. Note that Lemma 6.2.3 tells us that for all $n \in \mathbb{N}$ it is the case that $\mathfrak{J}_\tau(\text{Tun}_n)(x) = x$. This combined with Lemma 5.2.5 then tells us that for all $n \in \mathbb{N}$ it is the case for all $\nu \in \text{NN}$ that:

$$\mathfrak{J}_\tau(\text{Tun}_n \bullet \nu)(x) = \mathfrak{J}_\tau(\nu)(x) \quad (5.6.31)$$

Thus, this means that:

$$\begin{aligned} \mathfrak{J}_\tau(\nu_1 \diamond \nu_2)(x) &= \left(\text{Sum}_{n, \text{O}(\nu_2)} \bullet [\nu_1 \diamond \nu_2] \bullet \text{Cpy}_{n, \text{l}(\nu_1)} \right) \\ &= \mathfrak{J}_\tau(\nu_1)(x) + \mathfrak{J}_\tau(\nu_2)(x) \end{aligned} \quad (5.6.32)$$

This then proves the lemma. □

Lemma 5.6.20. *Let $n \in \mathbb{N}$. Let $\nu_1, \nu_2, \dots, \nu_n \in \text{NN}$. Let it also be the case that they have the same end-widths. It is then the case that:*

$$\mathfrak{J}_\tau(\diamond_{i=1}^n \nu_i)(x) = \sum_{i=1}^n \mathfrak{J}_\tau(\nu_i)(x) \quad (5.6.33)$$

Proof. This is a consequence of a finite number of applications of Lemma 5.6.19. □

5.7 Linear Combinations of ANNs and Their Properties

Definition 5.7.1 (Scalar left-multiplication with an ANN). *Let $\lambda \in \mathbb{R}$. We will denote by $(\cdot) \triangleright (\cdot) : \mathbb{R} \times \text{NN} \rightarrow \text{NN}$ the function that satisfy for all $\lambda \in \mathbb{R}$ and $\nu \in \text{NN}$ that $\lambda \triangleright \nu = \text{Aff}_{\lambda \mathbb{I}_{\text{O}(\nu)}, 0} \bullet \nu$.*

Definition 5.7.2 (Scalar right-multiplication with an ANN). *Let $\lambda \in \mathbb{R}$. We will denote by $(\cdot) \triangleleft (\cdot) : \text{NN} \times \mathbb{R} \rightarrow \text{NN}$ the function satisfying for all $\nu \in \text{NN}$ and $\lambda \in \mathbb{R}$ that $\nu \triangleleft \lambda = \nu \bullet \text{Aff}_{\lambda \mathbb{I}_{(\nu)}, 0}$.*

Remark 5.7.3. *Note that whereas $\lambda \in \mathbb{R}$, the actual neural network in question, properly speaking, must always be referred to as $\lambda \triangleright$ or $\triangleleft \lambda$, and we shall do so whenever this comes up in any neural*

network diagrams. This is by analogy with, for example, \log_λ or \surd for $\lambda \neq 0$, where the argument λ is generally always written except for $\lambda = 10$ for the logarithm or $\lambda = 2$ for the root.

Remark 5.7.4. For an R implementation, see Listing 10.8

Lemma 5.7.5. Let $\lambda \in \mathbb{R}$ and $\nu \in \mathbb{NN}$. It is then the case that:

(i) $L(\lambda \triangleright \nu) = L(\nu)$

(ii) For all $\mathbf{a} \in C(\mathbb{R}, \mathbb{R})$ that $\mathfrak{J}_\mathbf{a}(\lambda \triangleright \nu) \in C(\mathbb{R}^{l(\nu)}, \mathbb{R}^{O(\nu)})$

(iii) For all $\mathbf{a} \in C(\mathbb{R}, \mathbb{R})$, and $x \in \mathbb{R}^{l(\nu)}$ that:

$$\mathfrak{J}_\mathbf{a}(\lambda \triangleright \nu) = \lambda \mathfrak{J}_\mathbf{a}(\nu) \tag{5.7.1}$$

Proof. Let $\nu \in \mathbb{NN}$ such that $L(\nu) = (l_1, l_2, \dots, l_L)$ and $D(\nu) = L$ where $l_1, l_2, \dots, l_L, L \in \mathbb{N}$. Then Item (i) of Lemma 5.5.2 tells us that:

$$L(\text{Aff}_{\mathbb{I}_{O(\nu)}, 0}) = (O(\nu), O(\nu)) \tag{5.7.2}$$

This and Item (i) from Lemma 5.5.5 gives us that:

$$L(\lambda \triangleright \nu) = L(\text{Aff}_{\lambda \mathbb{I}_{O(\nu)}, 0} \bullet \nu) = (l_0, l_1, \dots, l_{L-1}, O(\nu)) = L(\nu) \tag{5.7.3}$$

Which proves (i). Item (ii) – (iii) of Lemma 5.5.2 then prove that for all $\mathbf{a} \in C(\mathbb{R}, \mathbb{R})$, $x \in \mathbb{R}^{l(\nu)}$, that $\mathfrak{J}_\mathbf{a}(\lambda \triangleright \nu) \in C(\mathbb{R}^{l(\nu)}, \mathbb{R}^{O(\nu)})$ given by:

$$\begin{aligned} (\mathfrak{J}_\mathbf{a}(\lambda \triangleright \nu))(x) &= \left(\mathfrak{J}_\mathbf{a}(\text{Aff}_{\lambda \mathbb{I}_{O(\nu)}, 0} \bullet \nu) \right)(x) \\ &= \lambda \mathbb{I}_{O(\nu)}((\mathfrak{J}_\mathbf{a}(\nu))(x)) = \lambda((\mathfrak{J}_\mathbf{a}(\nu))(x)) \end{aligned} \tag{5.7.4}$$

This establishes Items (ii)–(iii), completing the proof. □

Lemma 5.7.6. Let $\lambda \in \mathbb{R}$ and $\nu \in \mathbb{NN}$. It is then the case that:

(i) $L(\nu \triangleleft \lambda) = L(\nu)$

(ii) For all $\mathbf{a} \in C(\mathbb{R}, \mathbb{R})$ that $\mathfrak{J}_{\mathbf{a}}(\nu \triangleleft \lambda) \in C(\mathbb{R}^{l(\nu)}, \mathbb{R}^{o(\nu)})$

(iii) For all $\mathbf{a} \in C(\mathbb{R}, \mathbb{R})$, and $x \in \mathbb{R}^{l(\nu)}$ that:

$$\mathfrak{J}_{\mathbf{a}}(\nu \triangleleft \lambda) = \mathfrak{J}_{\mathbf{a}}(\nu)(\lambda x) \quad (5.7.5)$$

Proof. Let $\nu \in \mathbb{N}\mathbb{N}$ such that $L(\nu) = (l_1, l_2, \dots, l_L)$ and $D(\nu) = L$ where $B_1, l_2, \dots, l_L, L \in \mathbb{N}$. Then Item (i) of Lemma 5.5.2 tells us that:

$$L(\text{Aff}_{\mathbb{I}(\nu), 0}) = (l(\nu), l(\nu)) \quad (5.7.6)$$

This and Item (iv) of Lemma 5.5.5 tells us that:

$$L(\nu \triangleleft \lambda) = L(\nu \bullet \text{Aff}_{\lambda \mathbb{I}(\nu)}) = (l(\nu), l_1, l_2, \dots, l_L) = L(\nu) \quad (5.7.7)$$

Which proves (i). Item (v)--(vi) of Lemma 5.5.5 then prove that for all $\mathbf{a} \in C(\mathbb{R}, \mathbb{R})$, $x \in \mathbb{R}^{l(\nu)}$ that $\mathfrak{J}_{\mathbf{a}}(\nu \triangleleft \lambda) \in C(\mathbb{R}^{l(\nu)}, \mathbb{R}^{o(\nu)})$ given by:

$$\begin{aligned} (\mathfrak{J}_{\mathbf{a}}(\nu \triangleleft \lambda))(x) &= \left(\mathfrak{J}_{\mathbf{a}}(\nu \bullet \text{Aff}_{\lambda \mathbb{I}(\nu), 0}) \right)(x) \\ &= (\mathfrak{J}_{\mathbf{a}}(\nu))(\text{Aff}_{\lambda \mathbb{I}(\nu)})(x) \\ &= (\mathfrak{J}_{\mathbf{a}}(\nu))(\lambda x) \end{aligned} \quad (5.7.8)$$

This completes the proof. □

Lemma 5.7.7. Let $\nu, \mu \in \mathbb{N}\mathbb{N}$ with the same length and end-widths, and $\lambda \in \mathbb{R}$. It is then the case, for all $\mathbf{a} \in C(\mathbb{R}, \mathbb{R})$ that:

$$\begin{aligned} \mathfrak{J}_{\mathbf{a}}((\nu \oplus \mu) \triangleleft \lambda)(x) &= \mathfrak{J}_{\mathbf{a}}((\nu \triangleleft \lambda) \oplus (\mu \triangleleft \lambda))(x) \\ &= (\mathfrak{J}_{\mathbf{a}}(\nu))(\lambda x) + (\mathfrak{J}_{\mathbf{a}}(\mu))(\lambda x) \end{aligned}$$

Proof. Let $\nu = ((W_1, b_1), (W_2, b_2), \dots, (W_L, b_L))$ and $\mu = ((W'_1, b'_1), (W'_2, b'_2), \dots, (W'_L, b'_L))$. Then

from Lemma 5.7.6 and (5.6.27) we have that:

$$\begin{aligned}
& (\mathfrak{J}_{\mathbf{a}}(\nu \oplus \mu) \triangleleft \lambda)(x) \\
&= (\mathfrak{J}_{\mathbf{a}}(\nu \oplus \mu))(\lambda x) \\
&= \begin{bmatrix} W_L & W'_L \end{bmatrix} \begin{bmatrix} \mathfrak{J}_{\mathfrak{r}}(W_{L-1}(\dots(\mathfrak{J}_{\mathfrak{r}}(W_2(\mathfrak{J}_{\mathfrak{r}}(W_1\lambda x + b_1)) + b_2)) + \dots) + b_{L-1}) \\ \mathfrak{J}_{\mathfrak{r}}(W'_{L-1}(\dots(\mathfrak{J}_{\mathfrak{r}}(W'_2(\mathfrak{J}_{\mathfrak{r}}(W'_1\lambda x + b'_1)) + b'_2)) + \dots) + b'_{L-1}) \end{bmatrix} + b_L + b'_L
\end{aligned}$$

Note that:

$$(\mathfrak{J}_{\mathbf{a}}(\nu))(\lambda x) = W_L \cdot \mathfrak{J}_{\mathfrak{r}}(W_{L-1}(\dots(\mathfrak{J}_{\mathfrak{r}}(W_2(\mathfrak{J}_{\mathfrak{r}}(W_1\lambda x + b_1)) + b_2)) + \dots) + b_{L-1}) + b_L \quad (5.7.9)$$

and that:

$$(\mathfrak{J}_{\mathbf{a}}(\mu))(\lambda x) = W'_L \cdot \mathfrak{J}_{\mathfrak{r}}(W'_{L-1}(\dots(\mathfrak{J}_{\mathfrak{r}}(W'_2(\mathfrak{J}_{\mathfrak{r}}(W'_1\lambda x + b'_1)) + b'_2)) + \dots) + b'_{L-1}) + b'_L \quad (5.7.10)$$

This, together with Lemma 5.6.16, completes the proof. \square

Lemma 5.7.8. *Let $\nu, \mu \in \mathbb{N}\mathbb{N}$ with the same length and end-widths, and $\lambda \in \mathbb{R}$. It is then the case, for all $\mathbf{a} \in C(\mathbb{R}, \mathbb{R})$ that:*

$$\begin{aligned}
\mathfrak{J}_{\mathbf{a}}(\lambda \triangleright (\nu \oplus \mu))(x) &= \mathfrak{J}_{\mathbf{a}}((\lambda \triangleright \nu) \oplus (\lambda \triangleright \mu))(x) \\
&= \lambda \cdot (\mathfrak{J}_{\mathbf{a}}(\nu))(x) + \lambda \cdot (\mathfrak{J}_{\mathbf{a}}(\mu))(x)
\end{aligned}$$

Proof. Let $\nu = ((W_1, b_1), (W_2, b_2), \dots, (W_L, b_L))$ and $\mu = ((W'_1, b'_1), (W'_2, b'_2), \dots, (W'_L, b'_L))$. Then from Lemma 5.7.6 and (5.6.27) we have that:

$$\begin{aligned}
& \mathfrak{J}_{\mathbf{a}}(\lambda(\nu \oplus \mu))(x) \\
&= \mathfrak{J}_{\mathbf{a}}(\lambda \triangleright (\nu \oplus \mu))(\lambda x) \\
&= \lambda \cdot \begin{bmatrix} W_L & W'_L \end{bmatrix} \begin{bmatrix} \mathfrak{J}_{\mathfrak{r}}(W_{L-1}(\dots(\mathfrak{J}_{\mathfrak{r}}(W_2(\mathfrak{J}_{\mathfrak{r}}(W_1x + b_1)) + b_2)) + \dots) + b_{L-1}) \\ \mathfrak{J}_{\mathfrak{r}}(W'_{L-1}(\dots(\mathfrak{J}_{\mathfrak{r}}(W'_2(\mathfrak{J}_{\mathfrak{r}}(W'_1x + b'_1)) + b'_2)) + \dots) + b'_{L-1}) \end{bmatrix} + b_L + b'_L
\end{aligned}$$

Note that:

$$\lambda \cdot (\mathfrak{J}_{\mathbf{a}}(\nu))(x) = W_L \cdot \mathfrak{J}_{\mathfrak{r}}(W_{L-1}(\dots(\mathfrak{J}_{\mathfrak{r}}(W_2(\mathfrak{J}_{\mathfrak{r}}(W_1x + b_1)) + b_2)) + \dots) + b_{L-1}) + b_L \quad (5.7.11)$$

and that:

$$\lambda \cdot (\mathfrak{J}_{\mathbf{a}}(\mu))(x) = W'_L \cdot \mathfrak{J}_{\mathfrak{r}}(W'_{L-1}(\dots(\mathfrak{J}_{\mathfrak{r}}(W'_2(\mathfrak{J}_{\mathfrak{r}}(W'_1x + b'_1)) + b'_2)) + \dots) + b'_{L-1}) + b'_L \quad (5.7.12)$$

This, together with Lemma 5.6.16, completes the proof. \square

Lemma 5.7.9. *Let $u, v \in \mathbb{Z}$ with $u \leq v$ and $n = v - u + 1$. Let $\lambda_u, \lambda_{u+1}, \dots, \lambda_v \in \mathbb{R}$. Let $\nu_u, \nu_{u+1}, \dots, \nu_v, \mu \in \mathbb{NN}$, $B_u, B_{u+1}, \dots, B_v \in \mathbb{R}^{l(\mu)}$ satisfy that $\mathbb{L}(\nu_u) = \mathbb{L}(\nu_{u+1}) = \dots = \mathbb{L}(\nu_v)$ and further that:*

$$\mu = \left[\bigoplus_{i=u}^v \left(c_i \triangleright \left(\nu_i \bullet \text{Aff}_{\mathbb{I}(\nu_i), B_i} \right) \right) \right] \quad (5.7.13)$$

It then holds:

(i) *That:*

$$\begin{aligned} \mathbb{L}(\mu) &= \left(\mathbb{I}(\nu_u), \sum_{i=u}^v \mathbb{W}_1(\nu_u), \sum_{i=u}^v \mathbb{W}_2(\nu_u), \dots, \sum_{i=u}^v \mathbb{W}_{\mathbb{D}(\nu_u)-1}(\nu_u), \mathbb{O}(\nu_u) \right) \\ &= (\mathbb{I}(\nu_u), n \mathbb{W}_1(\nu_u), n \mathbb{W}_2(\nu_u), \dots, n \mathbb{W}_{\mathbb{D}(\nu_u)-1}(\nu_u), \mathbb{O}(\nu_u)) \end{aligned}$$

(ii) *that for all $\mathbf{a} \in C(\mathbb{R}, \mathbb{R})$, that $\mathfrak{J}_{\mathbf{a}}(\mu) \in C(\mathbb{R}^{l(\nu_u)}, \mathbb{R}^{\mathbb{O}(\nu_u)})$, and*

(iii) *for all $\mathbf{a} \in C(\mathbb{R}, \mathbb{R})$ and $x \in \mathbb{R}^{l(\nu_u)}$ that:*

$$(\mathfrak{J}_{\mathbf{a}}(\mu))(x) = \sum_{i=u}^v c_i (\mathfrak{J}_{\mathbf{a}}(\nu_i))(x + B_i) \quad (5.7.14)$$

Proof. Assume hypothesis that $\mathbb{L}(\nu_u) = \mathbb{L}(\nu_{u+1}) = \dots = \mathbb{L}(\nu_v)$. Note that Item (i) of Lemma 5.5.2 gives us that for all $i \in \{u, u+1, \dots, v\}$ that:

$$\mathbb{L}(\text{Aff}_{\mathbb{I}(\nu_i), B_i}) = \mathbb{L}(\text{Aff}_{\mathbb{I}(\nu_u)}) = (\mathbb{I}(\nu_u), \mathbb{I}(\nu_u)) \in \mathbb{N}^2 \quad (5.7.15)$$

This together with Lemma 5.2.5, Item (i), assures us that for all $i \in \{u, u + 1, \dots, v\}$ it is the case that:

$$\mathbb{L} \left(\nu_i \bullet \text{Aff}_{\mathbb{I}(\nu_i), B_i} \right) = (\mathbb{I}(\nu_u), \mathbb{W}_1(\nu_u), \mathbb{W}_2(\nu_u), \dots, \mathbb{W}_{\mathbb{D}(\nu_u)}(\nu_u)) \quad (5.7.16)$$

This and (Grohs et al., 2022, Lemma 3.14, Item (i)) tells us that for all $i \in \{u, u + 1, \dots, v\}$ it is the case that:

$$\mathbb{L} \left(c_i \triangleright \left(\nu_i \bullet \text{Aff}_{\mathbb{I}(\nu_i), B_i} \right) \right) = \mathbb{L} \left(\nu_i \bullet \text{Aff}_{\mathbb{I}(\nu_i), B_i} \right) \quad (5.7.17)$$

This, (5.7.16), and (Grohs et al., 2022, Lemma 3.28, Item (ii)) then yield that:

$$\begin{aligned} \mathbb{L}(\mu) &= \mathbb{L} \left(\bigoplus_{i=u}^v \left(c_i \triangleright \left(\nu_i \bullet \text{Aff}_{\mathbb{I}(\nu_i), B_i} \right) \right) \right) \\ &= \left(\mathbb{I}(\nu_u), \sum_{i=u}^v \mathbb{W}_1(\nu_u), \sum_{i=u}^v \mathbb{W}_2(\nu_u), \dots, \sum_{i=u}^v \mathbb{W}_{\mathbb{D}(\nu_u)-1}(\nu_u), \mathbb{O}(\nu_u) \right) \\ &= (\mathbb{I}(\nu_u), n \mathbb{W}_1(\nu_u), n \mathbb{W}_2(\nu_u), \dots, n \mathbb{W}_{\mathbb{D}(\nu_u)-1}(\nu_u), \mathbb{O}(\nu_u)) \end{aligned} \quad (5.7.18)$$

This establishes item (i). Items (v) and (vi) from Lemma 5.5.5 tells us that for all $i \in \{u, u + 1, \dots, v\}$, $\mathbf{a} \in C(\mathbb{R}, \mathbb{R})$, $x \in \mathbb{R}^{\mathbb{I}(\nu_u)}$, it is the case that $\mathfrak{J}_{\mathbf{a}} \left(\nu_i \bullet \text{Aff}_{\mathbb{I}(\nu_i), B_i} \right) \in C(\mathbb{R}^{\mathbb{I}(\nu_u)}, \mathbb{R}^{\mathbb{O}(\nu_u)})$ and further that:

$$\left(\mathfrak{J}_{\mathbf{a}} \left(\nu_i \bullet \text{Aff}_{\mathbb{I}(\nu_i), B_i} \right) \right) (x) = (\mathfrak{J}_{\mathbf{a}}(\nu_i)) (x + b_i) \quad (5.7.19)$$

This along with (Grohs et al., 2022, Lemma 3.14) ensures that for all $i \in \{u, u + 1, \dots, v\}$, $\mathbf{a} \in C(\mathbb{R}, \mathbb{R})$, $x \in \mathbb{R}^{\mathbb{I}(\nu_u)}$, it is the case that:

$$\mathfrak{J}_{\mathbf{a}} \left(c_i \triangleright \left(\nu_i \bullet \text{Aff}_{\mathbb{I}(\nu_i), B_i} \right) \right) \in C \left(\mathbb{R}^{\mathbb{I}(\nu_u)}, \mathbb{R}^{\mathbb{O}(\nu_u)} \right) \quad (5.7.20)$$

and:

$$\left(\mathfrak{J}_{\mathbf{a}} \left(c_i \triangleright \left(\nu_i \bullet \text{Aff}_{\mathbb{I}(\nu_i), B_i} \right) \right) \right) (x) = c_i (\mathfrak{J}_{\mathbf{a}}(\nu_i)) (x + b_i) \quad (5.7.21)$$

Now observe that (Grohs et al., 2022, Lemma 3.28) and (5.7.17) ensure that for all $\mathbf{a} \in C(\mathbb{R}, \mathbb{R})$,

$x \in \mathbb{R}^{l(\nu_u)}$, it is the case that $\mathfrak{J}_a(\mu) \in C(\mathbb{R}^{l(\nu_u)}, \mathbb{R}^{o(\nu_u)})$ and that:

$$\begin{aligned} (\mathfrak{J}_a(\mu))(x) &= \left(\mathfrak{J}_a \left(\oplus_{i=u}^v \left(c_i \triangleright \left(\nu_i \bullet \text{Aff}_{\mathbb{I}(\nu_i), b_i} \right) \right) \right) \right) (x) \\ &= \sum_{i=u}^v \left(\mathfrak{J}_a \left(c_i \triangleright \left(\nu_i \bullet \text{Aff}_{\mathbb{I}(\nu_i), b_i} \right) \right) \right) (x) \\ &= \sum_{i=u}^v c_i (\mathfrak{J}_a(\nu_i))(x + b_i) \end{aligned}$$

This establishes items (ii)--(iii); thus, the proof is complete. \square

Lemma 5.7.10. *Let $u, v \in \mathbb{Z}$ with $u \leq v$. Let $\lambda_u, \lambda_{u+1}, \dots, \lambda_v \in \mathbb{R}$. Let $\nu_u, \nu_{u+1}, \dots, \nu_v, \mu \in \mathbb{NN}$, $B_u, B_{u+1}, \dots, B_v \in \mathbb{R}^{l(\mu)}$ satisfy that $\mathbb{L}(\nu_u) = \mathbb{L}(\nu_{u+1}) = \dots = \mathbb{L}(\nu_v)$ and further that:*

$$\mu = \left[\oplus_{i=u}^v \left(\left(\text{Aff}_{\mathbb{I}(\nu_i), b_i} \bullet \nu \right) \triangleleft c_i \right) \right] \quad (5.7.22)$$

It then holds:

(i) *That:*

$$\begin{aligned} \mathbb{L}(\mu) &= \left(\mathbb{I}(\nu_u), \sum_{i=u}^v \mathbb{W}_1(\nu_u), \sum_{i=u}^v \mathbb{W}_2(\nu_u), \dots, \sum_{i=u}^v \mathbb{W}_{\mathbb{D}(\nu_u)-1}(\nu_u), \mathbb{O}(\nu_u) \right) \\ &= (\mathbb{I}(\nu_u), n \mathbb{W}_1(\nu_u), n \mathbb{W}_2(\nu_u), \dots, n \mathbb{W}_{\mathbb{D}(\nu_u)-1}(\nu_u), \mathbb{O}(\nu_u)) \end{aligned} \quad (5.7.23)$$

(ii) *that for all $a \in C(\mathbb{R}, \mathbb{R})$, that $\mathfrak{J}_a(\mu) \in C(\mathbb{R}^{l(\nu_u)}, \mathbb{R}^{o(\nu_u)})$, and*

(iii) *for all $a \in C(\mathbb{R}, \mathbb{R})$ and $x \in \mathbb{R}^{l(\nu_u)}$ that:*

$$(\mathfrak{J}_a(\mu))(x) = \sum_{i=u}^v (\mathfrak{J}_a(\nu_i))(c_i x + b_i) \quad (5.7.24)$$

Proof. Assume hypothesis that $\mathbb{L}(\nu_u) = \mathbb{L}(\nu_{u+1}) = \dots = \mathbb{L}(\nu_v)$. Note that Item (i) of Lemma 5.5.2 gives us that for all $i \in \{u, u+1, \dots, v\}$ that:

$$\mathbb{L}(\text{Aff}_{\mathbb{I}(\nu_i), B_i}) = \mathbb{L}(\text{Aff}_{\mathbb{I}(\nu_u)}) = (\mathbb{I}(\nu_u), \mathbb{I}(\nu_u)) \in \mathbb{N}^2 \quad (5.7.25)$$

Note then that Lemma 5.2.5, Item (ii), tells us that for all $i \in \{u, u + 1, \dots, v\}$ it is the case that:

$$\mathbb{L} \left(\text{Aff}_{\mathbb{I}(\nu_i), B_i} \bullet \nu \right) = (\mathbb{I}(\nu_u), \mathbb{W}_1(\nu_u), \mathbb{W}_2(\nu_u), \dots, \mathbb{W}_{\mathbb{D}(\nu_u)}(\nu_u)) \quad (5.7.26)$$

This and Item (i) of Lemma 5.7.6 tells us that for all $i \in \{u, u + 1, \dots, v\}$ it is the case that:

$$\mathbb{L} \left(\left(\text{Aff}_{\mathbb{I}(\nu_i), b_i} \bullet \nu \right) \triangleleft c_i \right) = \mathbb{L} \left(\text{Aff}_{\mathbb{I}(\nu_i), b_i} \bullet \nu \right) \quad (5.7.27)$$

This, (5.7.26), and (Grohs et al., 2022, Lemma 3.28, Item (ii)) tell us that:

$$\begin{aligned} \mathbb{L}(\mu) &= \mathbb{L} \left(\bigoplus_{i=u}^v \left(\left(\text{Aff}_{\mathbb{I}(\nu_i), b_i} \bullet \nu_i \right) \triangleleft c_i \right) \right) \\ &= \left(\mathbb{I}(\nu_u), \sum_{i=u}^v \mathbb{W}_1(\nu_u), \sum_{i=u}^v \mathbb{W}_2(\nu_u), \dots, \sum_{i=u}^v \mathbb{W}_{\mathbb{D}(\nu_u)-1}(\nu_u), \mathbb{O}(\nu_u) \right) \\ &= (\mathbb{I}(\nu_u), n \mathbb{W}_1(\nu_u), n \mathbb{W}_2(\nu_u), \dots, n \mathbb{W}_{\mathbb{D}(\nu_u)-1}(\nu_u), \mathbb{O}(\nu_u)) \end{aligned} \quad (5.7.28)$$

This establishes Item (i). Items (i) and (ii) from Lemma 5.5.5 tells us that for all $i \in \{u, u + 1, \dots, v\}$, $\mathbf{a} \in C(\mathbb{R}, \mathbb{R})$, $x \in \mathbb{R}^{\mathbb{I}(\nu_u)}$, it is the case that $\mathfrak{J}_{\mathbf{a}} \left(\nu_i \bullet \text{Aff}_{\mathbb{I}(\nu_i), B_i} \right) \in C \left(\mathbb{R}^{\mathbb{I}(\nu_u)}, \mathbb{R}^{\mathbb{O}(\nu_u)} \right)$ and further that:

$$\left(\mathfrak{J}_{\mathbf{a}} \left(\text{Aff}_{\mathbb{I}(\nu_i), b_i} \bullet \nu_i \right) \right) (x) = (\mathfrak{J}_{\mathbf{a}}(\nu_i))(x) + b_i \quad (5.7.29)$$

This along with Lemma 5.7.6 ensures that for all $i \in \{u, u + 1, \dots, v\}$, $\mathbf{a} \in C(\mathbb{R}, \mathbb{R})$, $x \in \mathbb{R}^{\mathbb{I}(\nu_u)}$, it is the case that:

$$\mathfrak{J}_{\mathbf{a}} \left(\left(\text{Aff}_{\mathbb{I}(\nu_i), b_i} \bullet \nu_i \right) \triangleleft c_i \right) \in C \left(\mathbb{R}^{\mathbb{I}(\nu_u)}, \mathbb{R}^{\mathbb{O}(\nu_u)} \right) \quad (5.7.30)$$

and:

$$\left(\mathfrak{J}_{\mathbf{a}} \left(\left(\text{Aff}_{\mathbb{I}(\nu_i), b_i} \bullet \nu_i \right) \triangleleft c_i \right) \right) (x) = (\mathfrak{J}_{\mathbf{a}}(\nu_i))(c_i x + b_i) \quad (5.7.31)$$

Now observe that (Grohs et al., 2022, Lemma 3.28) and (??) ensure that for all $\mathbf{a} \in C(\mathbb{R}, \mathbb{R})$,

$x \in \mathbb{R}^{l(\nu_u)}$, it is the case that $\mathfrak{J}_a(\mu) \in C(\mathbb{R}^{l(\nu_u)}, \mathbb{R}^{O(\nu_u)})$ and that:

$$(\mathfrak{J}_a(\mu))(x) = \left(\mathfrak{J}_a \left(\bigoplus_{i=u}^v \left(\text{Aff}_{\mathbb{I}(\nu_i), b_i} \bullet \nu_i \right) \triangleleft c_i \right) \right) (x) \quad (5.7.32)$$

$$= \sum_{i=u}^v \left(\mathfrak{J}_a \left(\left(\text{Aff}_{\mathbb{I}(\nu_i), b_i} \bullet \nu_i \right) \triangleleft c_i \right) \right) (x) \quad (5.7.33)$$

$$= \sum_{i=u}^v (\mathfrak{J}_a(\nu_i))(c_i x + b_i)$$

This establishes items (ii)--(iii); thus, the proof is complete. \square

Lemma 5.7.11. *Let $L \in \mathbb{N}$, $u, v \in \mathbb{Z}$ with $u \leq v$. Let $c_u, c_{u+1}, \dots, c_v \in \mathbb{R}$. $\nu_u, \nu_{u+1}, \dots, \nu_v, \mu, \mathfrak{J} \in \mathbb{NN}$, $B_u, B_{u+1}, \dots, B_v \in \mathbb{R}^{l(\nu_u)}$, $\mathbf{a} \in C(\mathbb{R}, \mathbb{R})$, satisfy for all $j \in \mathbb{N} \cap [u, v]$ that $L = \max_{i \in \mathbb{N} \cap [u, v]} D(\nu_i)$, $l(\nu_j) = l(\nu_u)$, $O(\nu_j) = l(\mathfrak{J}) = O(\mathfrak{J})$, $H(\mathfrak{J}) = 1$, $\mathfrak{J}_a(\mathfrak{J}) = \mathbb{I}_{\mathbb{R}}$, and that:*

$$\mu = \boxplus_{i=u, \mathfrak{J}}^v \left(c_i \triangleright \left(\nu_i \bullet \text{Aff}_{\mathbb{I}(\nu_i), b_i} \right) \right) \quad (5.7.34)$$

We then have:

(i) *it holds that:*

$$L(\mu) = \left(l(\nu_u), \sum_{i=u}^v W_1(\mathfrak{E}_{L, \mathfrak{J}}(\nu_i)), \sum_{i=u}^v W_2(\mathfrak{E}_{L, \mathfrak{J}}(\nu_i)), \dots, \sum_{i=u}^v W_{L-1}(\mathfrak{E}_{L, \mathfrak{J}}(\nu_i), O(\nu_u)) \right) \quad (5.7.35)$$

(ii) *it holds that $\mathfrak{J}_a(\mu) \in C(\mathbb{R}^{l(\nu_u)}, \mathbb{R}^{O(\nu_u)})$, and that,*

(iii) *it holds for all $x \in \mathbb{R}^{l(\nu_u)}$ that:*

$$(\mathfrak{J}_a(\mu))(x) = \sum_{i=u}^v c_i (\mathfrak{J}_a(\nu_i))(x + b_i) \quad (5.7.36)$$

Proof. Note that Item(i) from Lemma 5.7.9 establish Item(i) and (5.6.25); in addition, items (v) and (vi) from Lemma 5.5.5 tell us that for all $i \in \mathbb{N} \cap [u, v]$, $x \in \mathbb{R}^{l(\nu_u)}$, it holds that

$\mathfrak{J}_a \left(\nu_i \bullet \text{Aff}_{\mathbb{I}(\nu_i), B_i} \in C \left(\mathbb{R}^{l(\nu_u)}, \mathbb{R}^{o(\nu_u)} \right) \right)$ and further that:

$$\left(\mathfrak{J}_a \left(\nu_i \bullet \text{Aff}_{\mathbb{I}(\nu_i), B_i} \right) \right) (x) = \left(\mathfrak{J}_a (\nu_i) \right) (x + b_i) \quad (5.7.37)$$

This, Lemma 5.7.5 and (Grohs et al., 2023, Lemma 2.14, Item (ii)) show that for all $i \in \mathbb{N} \cap [u, v]$, $x \in \mathbb{R}^{l(\nu_u)}$, it holds that:

$$\mathfrak{J}_a \left(\mathfrak{E}_{L, \mathfrak{J}} \left(c_i \triangleright \left(\nu_i \bullet \text{Aff}_{\mathbb{I}(\nu_i), b_i} \right) \right) \right) = \mathfrak{J}_a \left(c_i \triangleright \left(\nu_i \bullet \text{Aff}_{\mathbb{I}(\nu_i), b_i} \right) \right) \in C \left(\mathbb{R}^{l(\nu_u)}, \mathbb{R}^{o(\nu_u)} \right) \quad (5.7.38)$$

and:

$$\begin{aligned} \left(\mathfrak{J}_a \left(\mathfrak{E}_{L, \mathfrak{J}} \left(c_i \triangleright \left(\nu_i \bullet \text{Aff}_{\mathbb{I}(\nu_i), b_i} \right) \right) \right) \right) (x) &= \left(\mathfrak{J}_a \left(c_i \triangleright \left(\nu_i \bullet \text{Aff}_{\mathbb{I}(\nu_i), b_i} \right) \right) \right) (x) \\ &= c_i \left(\mathfrak{J}_a (\nu_i) \right) (x + b_i) \end{aligned} \quad (5.7.39)$$

This combined with (Grohs et al., 2022, Lemma 3.28) and (5.7.17) demonstrate that for all $x \in \mathbb{R}^{l(\nu_u)}$ it holds that $\mathfrak{J}_a (\mu) \in C \left(\mathbb{R}^{l(\nu_u)}, \mathbb{R}^{o(\nu_u)} \right)$ and that:

$$\begin{aligned} \left(\mathfrak{J}_a (\mu) \right) (x) &= \left(\mathfrak{J}_a \left(\boxplus_{i=u, \mathfrak{J}}^v \left(c_i \triangleright \left(\nu_i \bullet \text{Aff}_{\mathbb{I}(\nu_i)} \right) \right) \right) \right) (x) \\ &= \left(\mathfrak{J}_a \left(\oplus_{i=u}^v \mathfrak{E}_{L, \mathfrak{J}} \left(c_i \triangleright \left(\nu_i \bullet \text{Aff}_{\mathbb{I}(\nu_i), b_i} \right) \right) \right) \right) (x) \\ &= \sum_{i=u}^v c_i \left(\mathfrak{J}_a (\nu_i) \right) (x + b_i) \end{aligned} \quad (5.7.40)$$

This establishes Items(ii)--(iii), thus proving the lemma. \square

Lemma 5.7.12. *Let $L \in \mathbb{N}$, $u, v \in \mathbb{Z}$ with $u \leq v$. Let $c_u, c_{u+1}, \dots, c_v \in \mathbb{R}$. $\nu_u, \nu_{u+1}, \dots, \nu_v, \mu, \mathfrak{J} \in \mathbb{NN}$, $B_u, B_{u+1}, \dots, B_v \in \mathbb{R}^{l(\nu_u)}$, $\mathfrak{a} \in C(\mathbb{R}, \mathbb{R})$, satisfy for all $j \in \mathbb{N} \cap [u, v]$ that $L = \max_{i \in \mathbb{N} \cap [u, v]} D(\nu_i)$, $l(\nu_j) = l(\nu_u)$, $O(\nu_j) = l(\mathfrak{J}) = O(\mathfrak{J})$, $H(\mathfrak{J}) = 1$, $\mathfrak{J}_a(\mathfrak{J}) = \mathbb{I}_{\mathbb{R}}$, and that:*

$$\mu = \boxplus_{i=u, \mathfrak{J}}^v \left(\left(\text{Aff}_{\mathbb{I}(\nu_i), b_i} \bullet \nu_i \right) \triangleleft c_i \right) \quad (5.7.41)$$

We then have:

(i) it holds that:

$$L(\mu) = \left(l(\nu_u), \sum_{i=u}^v W_1(\mathfrak{E}_{L,\mathfrak{J}}(\nu_i)), \sum_{i=u}^v W_2(\mathfrak{E}_{L,\mathfrak{J}}(\nu_i)), \dots, \sum_{i=u}^v W_{L-1}(\mathfrak{E}_{L,\mathfrak{J}}(\nu_i), \mathcal{O}(\nu_u)) \right) \quad (5.7.42)$$

(ii) it holds that $\mathfrak{J}_a(\mu) \in C(\mathbb{R}^{l(\nu_u)}, \mathbb{R}^{\mathcal{O}(\nu_u)})$, and that,

(iii) it holds for all $x \in \mathbb{R}^{l(\nu_u)}$ that:

$$(\mathfrak{J}_a(\mu))(x) = \sum_{i=u}^v (\mathfrak{J}_a(\nu_i))(c_i x + b_i) \quad (5.7.43)$$

Proof. Note that Item(i) from Lemma 5.7.10 establish Item(i) and (5.6.25); in addition, items (ii) and (iii) from Lemma 5.5.5 tell us that for all $i \in \mathbb{N} \cap [u, v]$, $x \in \mathbb{R}^{l(\nu_u)}$, it holds that $\mathfrak{J}_a(\text{Aff}_{\mathbb{I}(\nu_i), B_i} \bullet \nu_i \in C(\mathbb{R}^{l(\nu_u)}, \mathbb{R}^{\mathcal{O}(\nu_u)}))$ and further that:

$$\left(\mathfrak{J}_a(\text{Aff}_{\mathbb{I}(\nu_i), B_i} \bullet \nu_i) \right)(x) = (\mathfrak{J}_a(\nu_i))(x) + b_k \quad (5.7.44)$$

This, Lemma 5.7.6 and (Grohs et al., 2023, Lemma 2.14, Item (ii)) show that for all $i \in \mathbb{N} \cap [u, v]$, $x \in \mathbb{R}^{l(\nu_u)}$, it holds that:

$$\mathfrak{J}_a(\mathfrak{E}_{L,\mathfrak{J}}(\left(\text{Aff}_{\mathbb{I}(\nu_i), b_i} \bullet \nu_i \right) \triangleleft c_i)) = \mathfrak{J}_a(\left(\text{Aff}_{\mathbb{I}(\nu_i), b_i} \bullet \nu_i \right) \triangleleft c_i) \in C(\mathbb{R}^{l(\nu_u)}, \mathbb{R}^{\mathcal{O}(\nu_u)}) \quad (5.7.45)$$

and:

$$\begin{aligned} \left(\mathfrak{J}_a(\mathfrak{E}_{L,\mathfrak{J}}(\left(\text{Aff}_{\mathbb{I}(\nu_i), b_i} \bullet \nu_i \right) \triangleleft c_i)) \right)(x) &= \left(\mathfrak{J}_a(c_i \triangleright (\nu_i \bullet \text{Aff}_{\mathbb{I}(\nu_i), b_i})) \right)(x) \\ &= (\mathfrak{J}_a(\nu_i))(c_i x + b_i) \end{aligned} \quad (5.7.46)$$

This and (Grohs et al., 2022, Lemma 3.28) and (5.7.27) demonstrate that for all $x \in \mathbb{R}^{l(\nu_u)}$ it holds

that $\mathcal{J}_a(\mu) \in C(\mathbb{R}^{l(\nu_u)}, \mathbb{R}^{o(\nu_u)})$ and that:

$$\begin{aligned}
 (\mathcal{J}_a(\mu))(x) &= \left(\mathcal{J}_a \left(\boxplus_{i=u, \mathcal{J}}^v \left(\left(\text{Aff}_{\mathbb{I}(\nu_i)} \bullet \nu_i \right) \triangleleft c_i \right) \right) \right) (x) \\
 &= \left(\mathcal{J}_a \left(\oplus_{i=u}^v \mathfrak{E}_{L, \mathcal{J}} \left(\left(\text{Aff}_{\mathbb{I}(\nu_i), b_i} \bullet \nu_i \right) \triangleleft c_i \right) \right) \right) (x) \\
 &= \sum_{i=u}^v (\mathcal{J}_a(\nu_i))(c_i x + b_i)
 \end{aligned} \tag{5.7.47}$$

This completes the proof. □

5.8 Neural Network Diagrams

Conceptually, it will be helpful to construct what are called "neural network diagrams". They take inspiration from diagrams typically seen in the literature, for instance, [Vaswani et al. \(2017a\)](#), [Arik and Pfister \(2021b\)](#), and [Chollet \(2017\)](#). They are constructed as follows. Lines with arrows indicate the flow of data:

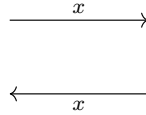

Named neural networks are always enclosed in boxes with serif fonts:



Where possible, we seek to label the arrows going in and going out of a boxed neural network with the appropriate operations that take place:



It is often more helpful to draw the arrows from right to left, as above.

Stacked neural networks are drawn in adjacent boxes.

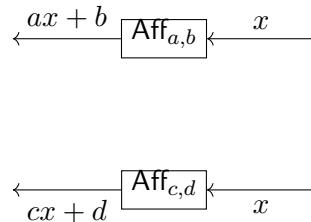

For neural networks that take in two inputs and give out one output, we use two arrows going in and one arrow going out:

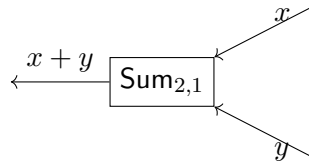

For neural networks that take in one input and give out two outputs, we use one arrow going in and two arrows going out:

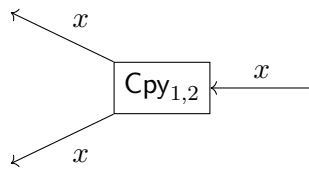

Thus taking this all together the sum of neural networks $\text{Aff}_{a,b}, \text{Aff}_{c,d} \in \text{NN}$ is given by:

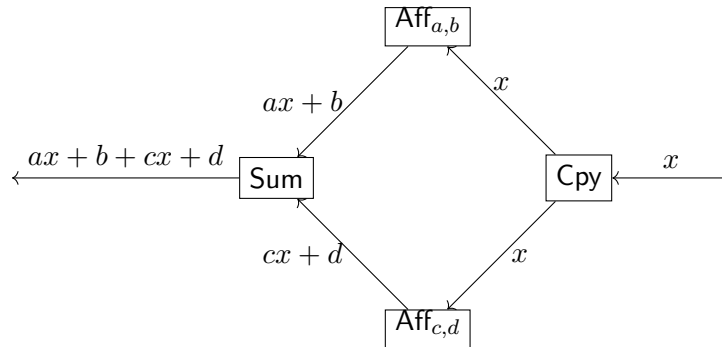

Chapter 6

ANN Product Approximations

6.1 Approximation for Products of Two Real Numbers

We will build up the tools necessary to approximate e^x via neural networks in the framework described in the previous sections. While much of the foundation comes from, e.g., [Grohs et al. \(2023\)](#) way, we will, along the way, encounter neural networks not seen in the literature, such as the Tay, Pwr, Tun, and finally a neural network approximant for e^x . For each of these neural networks, we will be concerned with at least the following:

- (i) whether their instantiations using the ReLU function (often just continuous functions) are continuous.
- (ii) whether their depths are bounded, at most polynomially, on the type of accuracy we want, ε .
- (iii) whether their parameter estimates are bounded at most polynomially on the type of accuracy we want, ε .
- (iv) The accuracy of our neural networks.

6.1.1 The squares of real numbers in $[0, 1]$

Definition 6.1.1 (The \mathbf{i}_d Network). *For all $d \in \mathbb{N}$ we will define the following set of neural networks as ``activation neural networks'' denoted \mathbf{i}_d as:*

$$\mathbf{i}_d = ((\mathbb{I}_d, \mathbf{0}_d), (\mathbb{I}_d, \mathbf{0}_d)) \quad (6.1.1)$$

Lemma 6.1.2. *Let $d \in \mathbb{N}$. It is then the case that:*

$$(i) \mathfrak{J}_\tau(\mathbf{i}_d) \in C(\mathbb{R}^d, \mathbb{R}^d).$$

$$(ii) \mathbf{L}(\mathbf{i}_d) = (d, d, d)$$

$$(iii) \mathbf{P}(\mathbf{i}_d) = 2d^2 + 2d$$

Proof. Item (i) is straightforward from the fact that for all $d \in \mathbb{N}$ it is the case that $\mathfrak{J}_\tau(\mathbf{i}_d) = \mathbb{I}_d(\mathfrak{J}_\tau([\mathbb{I}_d]_*)) + \mathbf{0}_d + \mathbf{0}_d$. Item (ii) is straightforward from the fact that $\mathbb{I}_d \in \mathbb{R}^{d \times d}$. We realize Item (iii) by observation. \square

Lemma 6.1.3. *Let $(c_k)_{k \in \mathbb{N}} \subseteq \mathbb{R}$, $(A_k)_{k \in \mathbb{N}} \in \mathbb{R}^{4 \times 4}$, $\mathbb{B} \in \mathbb{R}^{4 \times 1}$, $(C_k)_{k \in \mathbb{N}}$ satisfy for all $k \in \mathbb{N}$ that:*

$$A_k = \begin{bmatrix} 2 & -4 & 2 & 0 \\ 2 & -4 & 2 & 0 \\ 2 & -4 & 2 & 0 \\ -c_k & 2c_k & -c_k & 1 \end{bmatrix} \quad B = \begin{bmatrix} 0 \\ -\frac{1}{2} \\ -1 \\ 0 \end{bmatrix} \quad C_k = \begin{bmatrix} -c_k & 2c_k & -c_k & 1 \end{bmatrix} \quad (6.1.2)$$

and that:

$$c_k = 2^{1-2k} \quad (6.1.3)$$

Let $\Phi_k \in \mathbf{NN}$, $k \in \mathbb{N}$ satisfy for all $k \in [2, \infty) \cap \mathbb{N}$ that $\Phi_1 = (\text{Aff}_{C_{1,0}} \bullet \mathbf{i}_4) \bullet \text{Aff}_{\mathbf{e}_4, B}$, that for all $d \in \mathbb{N}$, $\mathbf{i}_d = ((\mathbb{I}_d, \mathbf{0}_d), (\mathbb{I}_d, \mathbf{0}_d))$ and that:

$$\Phi_k = (\text{Aff}_{C_{k,0}} \bullet \mathbf{i}_4) \bullet (\text{Aff}_{A_{k-1, B}} \bullet \mathbf{i}_4) \bullet \cdots \bullet (\text{Aff}_{A_{1, B}} \bullet \mathbf{i}_4) \bullet \text{Aff}_{\mathbf{e}_4, B} \quad (6.1.4)$$

It is then the case that:

(i) for all $k \in \mathbb{N}$, $x \in \mathbb{R}$ we have $\mathfrak{I}_\tau(\Phi_k)(x) \in C(\mathbb{R}, \mathbb{R})$

(ii) for all $k \in \mathbb{N}$ we have $\mathbf{L}(\Phi_k) = (1, 4, 4, \dots, 4, 1) \in \mathbb{N}^{k+2}$

(iii) for all $k \in \mathbb{N}$, $x \in \mathbb{R} \setminus [0, 1]$ that $(\mathfrak{I}_\tau(\Phi_k))(x) = \mathfrak{r}(x)$

(iv) for all $k \in \mathbb{N}$, $x \in [0, 1]$, we have $|x^2 - (\mathfrak{I}_\tau(\xi_k))(x)| \leq 2^{-2k-2}$, and

(v) for all $k \in \mathbb{N}$, we have that $\mathbf{P}(\Phi_k) = 20k - 7$

Proof. Let $g_k : \mathbb{R} \rightarrow [0, 1]$, $k \in \mathbb{N}$ be the functions defined as such, satisfying for all $k \in \mathbb{N}$, $x \in \mathbb{R}$ that:

$$g_1(x) = \begin{cases} 2x & : x \in [0, \frac{1}{2}) \\ 2 - 2x & : x \in [\frac{1}{2}, 1] \\ 0 & : x \in \mathbb{R} \setminus [0, 1] \end{cases} \quad (6.1.5)$$

$$g_{k+1} = g_1(g_k)$$

and let $f_k : [0, 1] \rightarrow [0, 1]$, $k \in \mathbb{N}_0$ be the functions satisfying for all $k \in \mathbb{N}_0$, $n \in \{0, 1, \dots, 2^k - 1\}$, $x \in [\frac{n}{2^k}, \frac{n+1}{2^k})$ that $f_k(1) = 1$ and:

$$f_k(x) = \left[\frac{2n+1}{2^k} \right] x - \frac{n^2+n}{2^{2k}} \quad (6.1.6)$$

and let $r_k = (r_{k,1}, r_{k,2}, r_{k,3}, r_{k,4}) : \mathbb{R} \rightarrow \mathbb{R}^4$, $k \in \mathbb{N}$ be the functions which which satisfy for all $x \in \mathbb{R}$, $k \in \mathbb{N}$ that:

$$r_1(x) = \begin{bmatrix} r_{1,1}(x) \\ r_{2,1}(x) \\ r_{3,1}(x) \\ r_{4,1}(x) \end{bmatrix} = \mathfrak{r} \left(\begin{bmatrix} x \\ x - \frac{1}{2} \\ x - 1 \\ x \end{bmatrix} \right) \quad (6.1.7)$$

$$r_{k+1} = A_{k+1} r_k(x)$$

Note that since it is the case that for all $x \in \mathbb{R}$ that $\mathfrak{r}(x) = \max\{x, 0\}$, (6.1.5) and (6.1.7) shows

that it holds for all $x \in \mathbb{R}$ that:

$$\begin{aligned}
2r_{1,1}(x) - 4r_{2,1}(x) + 2r_{3,1}(x) &= 2\mathfrak{r}(x) - 4\mathfrak{r}\left(x - \frac{1}{2}\right) + 2\mathfrak{r}(x - 1) \\
&= 2\max\{x, 0\} - 4\max\left\{x - \frac{1}{2}, 0\right\} + 2\max\{x - 1, 0\} \\
&= g_1(x)
\end{aligned} \tag{6.1.8}$$

Note also that combined with (6.1.6), the fact that for all $x \in [0, 1]$ it holds that $f_0(x) = x = \max\{x, 0\}$ tells us that for all $x \in \mathbb{R}$:

$$r_{4,1}(x) = \max\{x, 0\} = \begin{cases} f_0(x) & : x \in [0, 1] \\ \max\{x, 0\} & : x \in \mathbb{R} \setminus [0, 1] \end{cases} \tag{6.1.9}$$

We next claim that for all $k \in \mathbb{N}$, it is the case that:

$$(\forall x \in \mathbb{R} : 2r_{1,k}(x) - 4r_{2,k}(x) + 2r_{3,k}(x) = g(x)) \tag{6.1.10}$$

and that:

$$\left(\forall x \in \mathbb{R} : r_{4,k}(x) = \begin{cases} f_{k-1}(x) & : x \in [0, 1] \\ \max\{x, 0\} & : x \in \mathbb{R} \setminus [0, 1] \end{cases} \right) \tag{6.1.11}$$

We prove (6.1.10) and (6.1.11) by induction. The base case of $k = 1$ is proved by (6.1.8) and (6.1.9). For the induction step $\mathbb{N} \ni k \rightarrow k + 1$ assume there does exist a $k \in \mathbb{N}$ such that for all $x \in \mathbb{R}$ it is the case that:

$$2r_{1,k}(x) - 4r_{2,k}(x) + 2r_{3,k}(x) = g_k(x) \tag{6.1.12}$$

and:

$$r_{4,k}(x) = \begin{cases} f_{k-1}(x) & : x \in [0, 1] \\ \max\{x, 0\} & : x \in \mathbb{R} \setminus [0, 1] \end{cases} \tag{6.1.13}$$

Note that then (6.1.5), (6.1.7), and (6.1.8) then tells us that for all $x \in \mathbb{R}$ it is the case that:

$$\begin{aligned}
g_{k+1}(x) &= g_1(g_k(x)) = g_1(2r_{1,k}(x) + 4r_{2,k}(x) + 2r_{3,k}(x)) \\
&= 2\mathfrak{r}(2r_{1,k}(x) + 4r_{2,k}(x) + 2r_{3,k}(x)) \\
&\quad - 4\mathfrak{r}\left(2r_{1,k}(x) - 4r_{2,k}(x) + 2r_{3,k}(x) - \frac{1}{2}\right) \\
&\quad + 2\mathfrak{r}(2r_{1,k}(x) - 4r_{2,k}(x) + 2r_{3,k}(x) - 1) \\
&= 2r_{1,k+1}(x) - 4r_{2,k+1}(x) + 2r_{3,k+1}(x)
\end{aligned} \tag{6.1.14}$$

In addition note that (6.1.6), (6.1.7), and (6.1.9) tells us that for all $x \in \mathbb{R}$:

$$\begin{aligned}
r_{4,k+1}(x) &= \mathfrak{r}\left((-2)^{3-2(k+1)}r_{1,k}(x) + 2^{4-2(k+1)}r_{2,k}(x) + (-2)^{3-2(k+1)}r_{3,k}(x) + r_{4,k}(x)\right) \\
&= \mathfrak{r}\left((-2)^{1-2k}r_{1,k}(x) + 2^{2-2k}r_{2,k}(x) + (-2)^{1-2k}r_{3,k}(x) + r_{4,k}(x)\right) \\
&= \mathfrak{r}\left(2^{-2k}[-2r_{1,k}(x) + 2^2r_{2,k}(x) - 2r_{3,k}(x)] + r_{4,k}(x)\right) \\
&= \mathfrak{r}\left(-\left[2^{-2k}\right][2r_{1,k}(x) - 4r_{2,k}(x) + 2r_{3,k}(x)] + r_{4,k}(x)\right) \\
&= \mathfrak{r}\left(-\left[2^{-2k}\right]g_k(x) + r_{4,k}(x)\right)
\end{aligned} \tag{6.1.15}$$

This and the fact that for all $x \in \mathbb{R}$ it is the case that $\mathfrak{r}(x) = \max\{x, 0\}$, that for all $x \in [0, 1]$ it is the case that $f_k(x) \geq 0$, (6.1.13), shows that for all $x \in [0, 1]$ it holds that:

$$\begin{aligned}
r_{4,k+1}(x) &= \mathfrak{r}\left(-2\left[2^{-2k}g_k\right] + f_{k-1}(x)\right) = \mathfrak{r}\left(-2\left(2^{-2k}g_k(x)\right) + x - \left[\sum_{j=1}^{k-1} (2^{-2j}g_j(x))\right]\right) \\
&= \mathfrak{r}\left(x - \left[\sum_{j=1}^k 2^{-2j}g_j(x)\right]\right) = \mathfrak{r}(f_k(x)) = f_k(x)
\end{aligned} \tag{6.1.16}$$

Note next that (6.1.13) and (6.1.15) then tells us that for all $x \in \mathbb{R} \setminus [0, 1]$:

$$r_{4,k+1}(x) = \max\left\{-\left(2^{-2k}g_k(x)\right) + r_{4,k}(x)\right\} = \max\{\max\{x, 0\}, 0\} = \max\{x, 0\} \tag{6.1.17}$$

Combining (6.1.14) and (6.1.16) proves (6.1.10) and (6.1.11). Note that then (6.1.2) and (6.1.10)

assure that for all $k \in \mathbb{N}$, $x \in \mathbb{R}$ it holds that $\mathfrak{J}_\tau(\Phi_k) \in C(\mathbb{R}, \mathbb{R})$ and that:

$$\begin{aligned}
& (\mathfrak{J}_\tau(\Phi_k))(x) \\
&= (\mathfrak{J}_\tau((\text{Aff}_{C_k,0} \bullet \mathbf{i}_4) \bullet (\text{Aff}_{A_{k-1},B} \bullet \mathbf{i}_4) \bullet \cdots \bullet (\text{Aff}_{A_1,B} \bullet \mathbf{i}_4) \bullet \text{Aff}_{e_4,B})))(x) \\
&= (-2)^{1-2k} r_{1,k}(x) + 2^{2-2k} r_{2,k}(x) + (-2)^{1-2k} r_{3,k}(x) + r_{4,k}(x) \\
&= (-2)^{2-2k} \left(\left[\frac{r_{1,k}(x) + r_{3,k}(x)}{-2} \right] + r_{2,k}(x) \right) + r_{4,k}(x) \\
&= 2^{2-2k} \left(\left[\frac{r_{1,k}(x) + r_{3,k}(x)}{-2} \right] + r_{2,k}(x) \right) + r_{4,k}(x) \\
&= 2^{-2k} (4r_{2,k}(x) - 2r_{1,k}(x) - 2r_{3,k}(x)) + r_{4,k}(x) \\
&= - \left[2^{-2k} \right] [2r_{1,k}(x) - 4r_{2,k}(x) + 2r_{3,k}(x)] + r_{4,k}(x) = - \left[2^{-2k} \right] g_k(x) + r_{4,k}(x) \quad (6.1.18)
\end{aligned}$$

This and (6.1.11) tell us that:

$$\begin{aligned}
(\mathfrak{J}_\tau(\Phi_k))(x) &= - \left(2^{-2k} g_k(x) \right) + f_{k-1}(x) = - \left(2^{-2k} g_k(x) \right) + x - \left[\sum_{j=1}^{k-1} 2^{-2j} g_j(x) \right] \\
&= x - \left[\sum_{j=1}^k 2^{-2j} g_j(x) \right] = f_k(x)
\end{aligned}$$

Which then implies for all $k \in \mathbb{N}$, $x \in [0, 1]$ that it holds that:

$$\|x^2 - (\mathfrak{J}_\tau(\Phi_k))(x)\| \leq 2^{-2k-2} \quad (6.1.19)$$

This, in turn, establishes Item (i).

Finally observe that (6.1.18) then tells us that for all $k \in \mathbb{N}$, $x \in \mathbb{R} \setminus [0, 1]$ it holds that:

$$(\mathfrak{J}_\tau(\Phi_k))(x) = -2^{-2k} g_k(x) + r_{4,k}(x) = r_{4,k}(x) = \max\{x, 0\} = \mathfrak{r}(x) \quad (6.1.20)$$

This establishes Item(iv). Note next that Item(iii) ensures for all $k \in \mathbb{N}$ that $D(\xi_k) = k + 1$, and:

$$P(\Phi_k) = 4(1+1) + \left[\sum_{j=2}^k 4(4+1) \right] + (4+1) = 8 + 20(k-1) + 5 = 20k - 7 \quad (6.1.21)$$

This, in turn, proves Item(vi). The proof of the lemma is thus complete. \square

Remark 6.1.4. For an R implementation see Listing 10.13

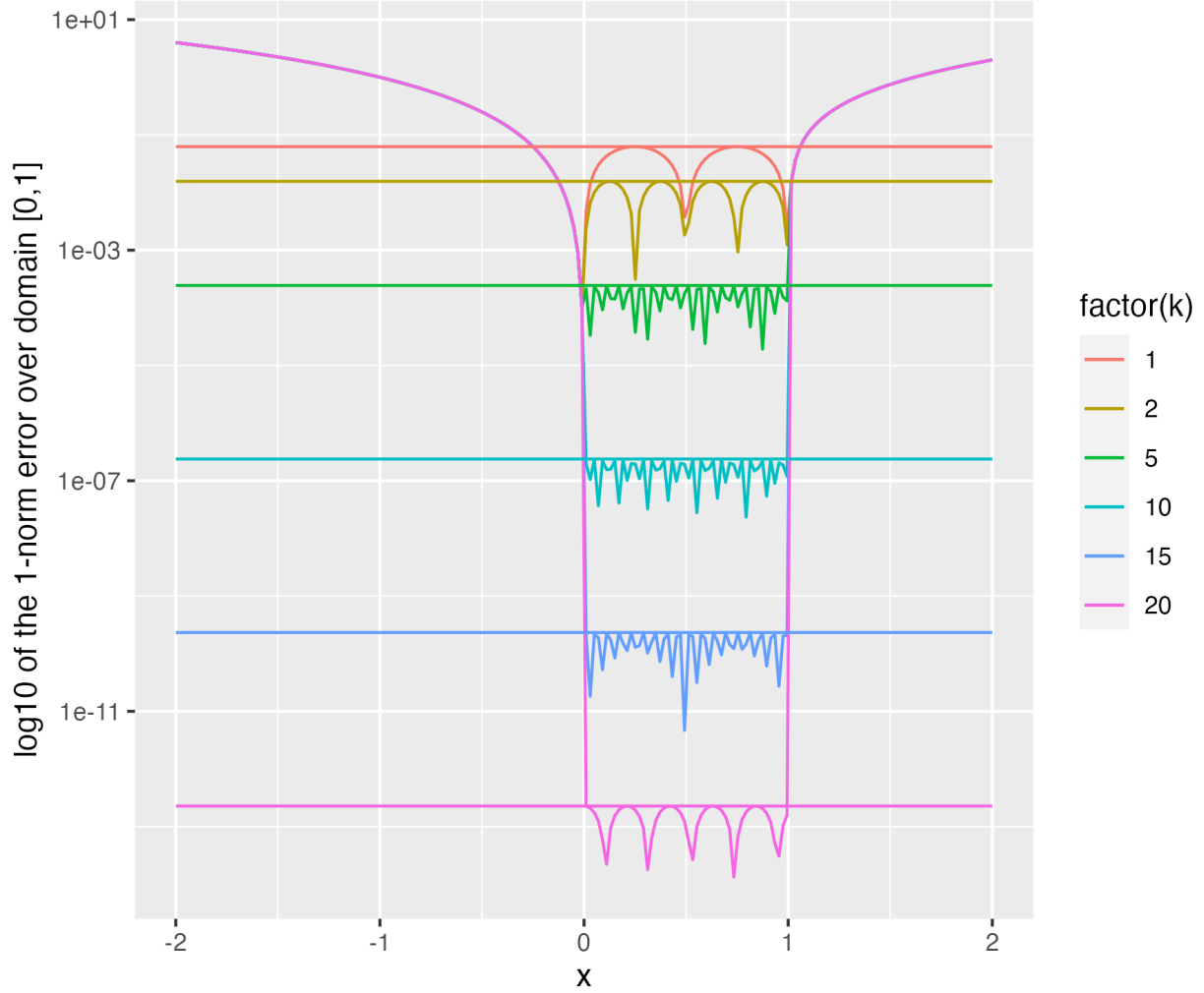

Figure 6.1: Plot of \log_{10} of the L^1 difference between Φ_k and x^2 over $[0, 1]$ for different values of k

Corollary 6.1.4.1. Let $\varepsilon \in (0, \infty)$, $M = \min\{\frac{1}{2} \log_2(\varepsilon^{-1}) - 1, \infty\} \cap \mathbb{N}$, $(c_k)_{k \in \mathbb{N}} \subseteq \mathbb{R}$, $(A_k)_{k \in \mathbb{N}} \subseteq \mathbb{R}^{4 \times 4}$, $B \in \mathbb{R}^{4 \times 1}$, $(C_k)_{k \in \mathbb{N}}$ satisfy for all $k \in \mathbb{N}$ that:

$$A_k = \begin{bmatrix} 2 & -4 & 2 & 0 \\ 2 & -4 & 2 & 0 \\ 2 & -4 & 2 & 0 \\ -c_k & 2c_k & -c_k & 1 \end{bmatrix}, \quad B = \begin{bmatrix} 0 \\ -\frac{1}{2} \\ -1 \\ 0 \end{bmatrix}, \quad C_k = \begin{bmatrix} -c_k & 2c_k & -c_k & 1 \end{bmatrix} \quad (6.1.22)$$

where:

$$c_k = 2^{1-2k} \quad (6.1.23)$$

and let $\Phi \in \mathbb{N}\mathbb{N}$ be defined as:

$$\Phi = \begin{cases} [\text{Aff}_{C_1,0} \bullet \mathbf{i}_4] \bullet \text{Aff}_{e_4,B} & M = 1 \\ [\text{Aff}_{C_M,0} \bullet \mathbf{i}_4] \bullet [\text{Aff}_{A_{M-1},0} \bullet \mathbf{i}_4] \bullet \cdots \bullet [\text{Aff}_{A_1,B} \bullet \mathbf{i}_4] \bullet \text{Aff}_{e_4,B} & M \in [2, \infty) \cap \mathbb{N} \end{cases} \quad (6.1.24)$$

it is then the case that:

(i) $\mathfrak{J}_\tau(\Phi) \in C(\mathbb{R}, \mathbb{R})$

(ii) $\mathbf{L}(\Phi) = (1, 4, 4, \dots, 4, 1) \in \mathbb{N}^{M+2}$

(iii) it holds for all $x \in \mathbb{R} \setminus [0, 1]$ that $(\mathfrak{J}_\tau(\Phi))(x) = \mathbf{r}(x)$

(iv) it holds for all $x \in [0, 1]$ that $|x^2 - (\mathfrak{J}_\tau(\Phi))(x)| \leq 2^{-2M-2} \leq \varepsilon$

(v) $\mathbf{D}(\Phi) \leq M + 1 \leq \max\{\frac{1}{2} \log_2(\varepsilon^{-1}) + 1, 2\}$, and

(vi) $\mathbf{P}(\Phi) = 20M - 7 \leq \max\{10 \log_2(\varepsilon^{-1}) - 7, 13\}$

Proof. Items (i)–(iii) are direct consequences of Lemma 6.1.3, Items (i)–(iii). Note next the fact that $M = \min\{\mathbb{N} \cap [\frac{1}{2} \log_2(\varepsilon^{-1}) - 1], \infty\}$ ensures that:

$$M = \min\left\{\mathbb{N} \cap \left[\frac{1}{2} \log_2(\varepsilon^{-1}) - 1\right], \infty\right\} \geq \min\left\{\left[\max\left\{1, \frac{1}{2} \log_2(\varepsilon^{-1}) - 1\right\}, \infty\right]\right\} \geq \frac{1}{2} \log_2(\varepsilon^{-1}) - 1 \quad (6.1.25)$$

This and Item (v) of Lemma 6.1.3 demonstrate that for all $x \in [0, 1]$ it then holds that:

$$|x^2 - (\mathfrak{J}_\tau(\Phi))(x)| \leq 2^{-2M-2} = 2^{-2(M+1)} \leq 2^{-\log_2(\varepsilon^{-1})} = \varepsilon \quad (6.1.26)$$

Thus establishing Item (iv). The fact that $M = \min\{\mathbb{N} \cap [\frac{1}{2} \log_2(\varepsilon^{-1}) - 1, \infty]\}$ and Item (ii) of

Lemma 6.1.3 tell us that:

$$D(\Phi) = M + 1 \leq \max \left\{ \frac{1}{2} \log_2 (\varepsilon^{-1}) + 1, 2 \right\} \quad (6.1.27)$$

Which establishes Item(v). This and Item (v) of Lemma 6.1.3 then tell us that:

$$P(\Phi_M) \leq 20M - 7 \leq 20 \max \left\{ \frac{1}{2} \log_2 (\varepsilon^{-1}), 2 \right\} - 7 = \max \{10 \log_2 (\varepsilon^{-1}) - 7, 13\} \quad (6.1.28)$$

This completes the proof of the corollary. □

Remark 6.1.5. For an implementation in R, see Listing 10.15

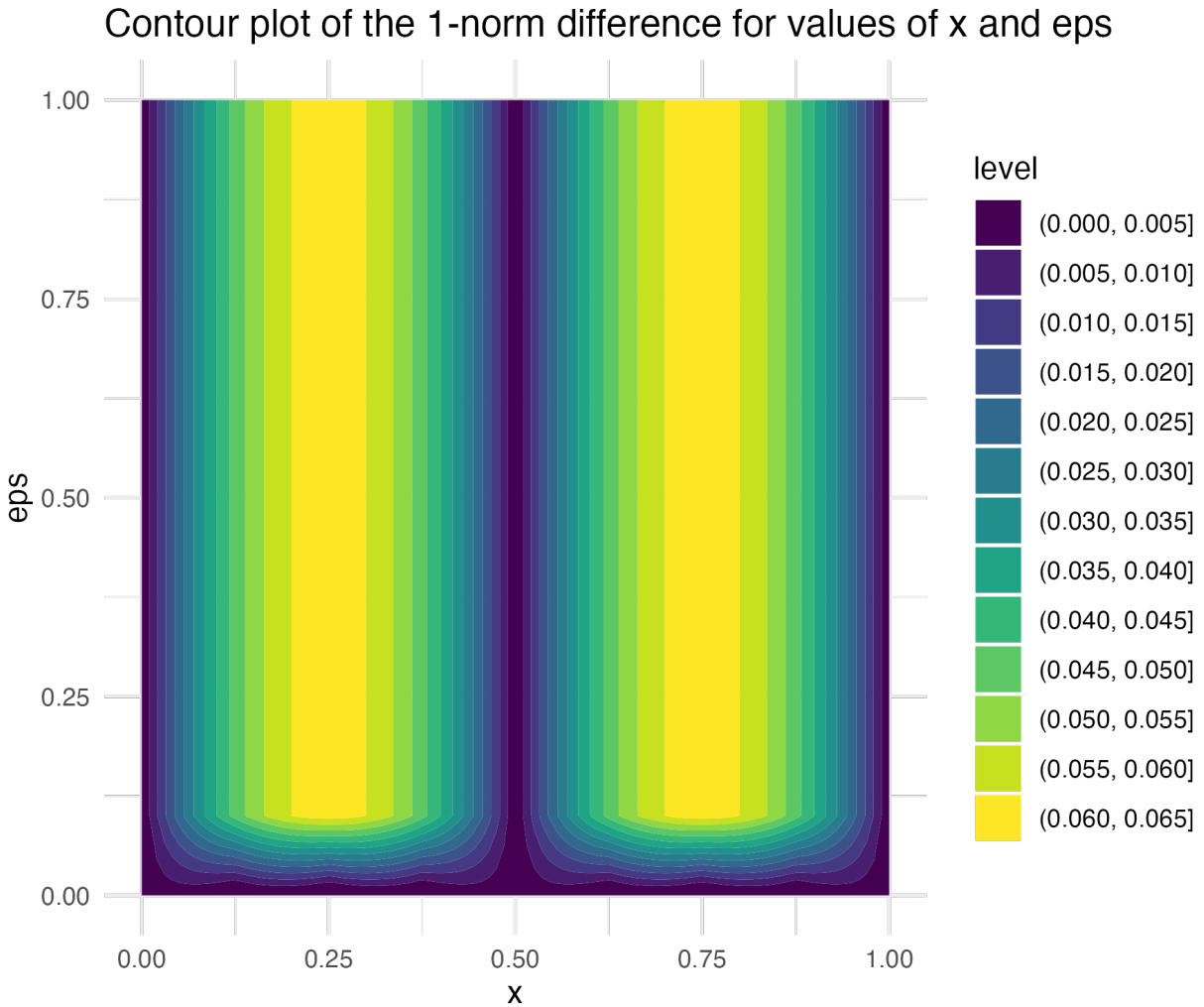

Figure 6.2: Contour plot of the L^1 difference between Φ and x^2 over $[0, 1]$ for different values of ε .

Remark 6.1.6. Note that (6.1.24) implies that $D(\Phi) \geq 4$.

Now that we have neural networks that perform the squaring operation inside $[-1, 1]$, we may extend to all of \mathbb{R} . Note that this neural network representation differs somewhat from the ones in Grohs et al. (2023).

6.1.2 The Sqr network

Lemma 6.1.7. Let $\delta, \epsilon \in (0, \infty)$, $\alpha \in (0, \infty)$, $q \in (2, \infty)$, $\Phi \in \text{NN}$ satisfy that $\delta = 2^{\frac{-2}{q-2}} \epsilon^{\frac{q}{q-2}}$, $\alpha = \left(\frac{\epsilon}{2}\right)^{\frac{1}{q-2}}$, $\mathfrak{J}_\tau(\Phi) \in C(\mathbb{R}, \mathbb{R})$, $D(\Phi) \leq \max\{\frac{1}{2} \log_2(\delta^{-1}) + 1, 2\}$, $P(\Phi) \leq \max\{10 \log_2(\delta^{-1}) - 7, 13\}$, $\sup_{x \in \mathbb{R} \setminus [0, 1]} |(\mathfrak{J}_\tau(\Phi) - \tau(x))| = 0$, and $\sup_{x \in [0, 1]} |x^2 - (\mathfrak{J}_\tau(\Phi))(x)| \leq \delta$, let $\Psi \in \text{NN}$ be the neural network given by:

$$\Psi = (\text{Aff}_{\alpha^{-2}, 0} \bullet \Phi \bullet \text{Aff}_{\alpha, 0}) \oplus (\text{Aff}_{\alpha^{-2}, 0} \bullet \Phi \bullet \text{Aff}_{-\alpha, 0}) \quad (6.1.29)$$

(i) it holds that $\mathfrak{J}_\tau(\Psi) \in C(\mathbb{R}, \mathbb{R})$.

(ii) it holds that $(\mathfrak{J}_\tau(\Psi))(0) = 0$

(iii) it holds for all $x \in \mathbb{R}$ that $0 \leq (\mathfrak{J}_\tau(\Psi))(x) \leq \epsilon + |x|^2$

(iv) it holds for all $x \in \mathbb{R}$ that $|x^2 - (\mathfrak{J}_\tau(\Psi))(x)| \leq \epsilon \max\{1, |x|^q\}$

(v) it holds that $D(\Psi) \leq \max\left\{1 + \frac{1}{q-2} + \frac{q}{2(q-2)} \log_2(\epsilon^{-1}), 2\right\}$, and

(vi) it holds that $P(\Psi) \leq \max\left\{\left\lceil \frac{40q}{q-2} \right\rceil \log_2(\epsilon^{-1}) + \frac{80}{q-2} - 28, 52\right\}$

Proof. Note that for all $x \in \mathbb{R}$ it is the case that:

$$\begin{aligned} (\mathfrak{J}_\tau(\Psi))(x) &= (\mathfrak{J}_\tau((\text{Aff}_{\alpha^{-2}} \bullet \Phi \bullet \text{Aff}_{\alpha, 0}) \oplus (\text{Aff}_{\alpha^{-2}, 0} \bullet \Phi \bullet \text{Aff}_{-\alpha, 0}))) (x) \\ &= (\mathfrak{J}_\tau(\text{Aff}_{\alpha^{-2}, 0} \bullet \Phi \bullet \text{Aff}_{\alpha, 0}))(x) + (\mathfrak{J}_\tau(\text{Aff}_{\alpha^{-2}, 0} \bullet \Phi \bullet \text{Aff}_{-\alpha, 0}))(x) \\ &= \frac{1}{\alpha^2} (\mathfrak{J}_\tau(\Phi))(\alpha x) + \frac{1}{\alpha^2} (\mathfrak{J}_\tau(\Phi))(-\alpha x) \\ &= \frac{1}{\left(\frac{\epsilon}{2}\right)^{\frac{2}{q-2}}} \left[(\mathfrak{J}_\tau(\Phi))\left(\left(\frac{\epsilon}{2}\right)^{\frac{1}{q-2}} x\right) + (\mathfrak{J}_\tau(\Phi))\left(-\left(\frac{\epsilon}{2}\right)^{\frac{1}{q-2}} x\right) \right] \end{aligned} \quad (6.1.30)$$

This and the assumption that $\Phi \in C(\mathbb{R}, \mathbb{R})$ along with the assumption that $\sup_{x \in \mathbb{R} \setminus [0,1]} |(\mathfrak{J}_\tau(\Phi))(x) - \mathfrak{r}(x)| = 0$ tells us that for all $x \in \mathbb{R}$ it holds that:

$$\begin{aligned} (\mathfrak{J}_\tau(\Psi))(0) &= \left(\frac{\varepsilon}{2}\right)^{\frac{-2}{q-2}} [(\mathfrak{J}_\tau(\Phi))(0) + (\mathfrak{J}_\tau(\Phi))(0)] \\ &= \left(\frac{\varepsilon}{2}\right)^{\frac{-2}{q-2}} [\mathfrak{r}(0) + \mathfrak{r}(0)] \\ &= 0 \end{aligned} \tag{6.1.31}$$

This, in turn, establishes Item (i)--(ii). Observe next that from the assumption that $\mathfrak{J}_\tau(\Phi) \in C(\mathbb{R}, \mathbb{R})$ and the assumption that $\sup_{x \in \mathbb{R} \setminus [0,1]} |(\mathfrak{J}_\tau(\Phi))(x) - \mathfrak{r}(x)| = 0$ ensure that for all $x \in \mathbb{R} \setminus [-1, 1]$ it holds that:

$$\begin{aligned} [\mathfrak{J}_\tau(\Phi)](x) + [\mathfrak{J}_\tau(\Phi)](-x) &= \mathfrak{r}(x) + \mathfrak{r}(-x) = \max\{x, 0\} + \max\{-x, 0\} \\ &= |x| \end{aligned} \tag{6.1.32}$$

The assumption that for all $\sup_{x \in \mathbb{R} \setminus [0,1]} |(\mathfrak{J}_\tau(\Phi))(x) - \mathfrak{r}(x)| = 0$ and the assumption that $\sup_{x \in [0,1]} |x^2 - (\mathfrak{J}_\tau(\Phi))(x)| \leq \delta$ show that:

$$\begin{aligned} &\sup_{x \in [-1,1]} |x^2 - ([\mathfrak{J}_\tau(\Phi)](x) + [\mathfrak{J}_\tau(\Phi)](x))| \\ &= \max \left\{ \sup_{x \in [-1,0]} |x^2 - (\mathfrak{r}(x) + [\mathfrak{J}_\tau(\Phi)](-x))|, \sup_{x \in [0,1]} |x^2 - ([\mathfrak{J}_\tau(\Phi)](x) + \mathfrak{r}(-x))| \right\} \\ &= \max \left\{ \sup_{x \in [-1,0]} |(-x)^2 - (\mathfrak{J}_\tau(\Phi))(-x)|, \sup_{x \in [0,1]} |x^2 - (\mathfrak{J}_\tau(\Phi))(x)| \right\} \\ &= \sup_{x \in [0,1]} |x^2 - (\mathfrak{J}_\tau(\Phi))(x)| \leq \delta \end{aligned} \tag{6.1.33}$$

Next observe that (6.1.30) and (6.1.32) show that for all $x \in \mathbb{R} \setminus \left[-\left(\frac{\varepsilon}{2}\right)^{\frac{-1}{q-2}}, \left(\frac{\varepsilon}{2}\right)^{\frac{-1}{q-2}}\right]$ it holds that:

$$\begin{aligned} 0 \leq [\mathfrak{J}_\tau(\Psi)](x) &= \left(\frac{\varepsilon}{2}\right)^{\frac{-2}{q-2}} \left([\mathfrak{J}_\tau(\Phi)] \left(\left(\frac{\varepsilon}{2}\right)^{\frac{1}{q-2}} x \right) + [\mathfrak{J}_\tau(\Phi)] \left(-\left(\frac{\varepsilon}{2}\right)^{\frac{1}{q-2}} x \right) \right) \\ &= \left(\frac{\varepsilon}{2}\right)^{\frac{-2}{q-2}} \left| \left(\frac{\varepsilon}{2}\right)^{\frac{1}{q-2}} x \right| = \left(\frac{\varepsilon}{2}\right)^{\frac{-1}{q-2} |x|} \leq |x|^2 \end{aligned} \tag{6.1.34}$$

The triangle inequality then tells us that for all $x \in \mathbb{R} \setminus \left[-\left(\frac{\varepsilon}{2}\right)^{\frac{-1}{q-2}}, \left(\frac{\varepsilon}{2}\right)^{\frac{-1}{q-2}}\right]$ it holds that:

$$\begin{aligned}
|x^2 - (\mathfrak{J}_\tau(\Psi))(x)| &= \left| x^2 - \left(\frac{\varepsilon}{2}\right)^{\frac{-1}{q-2}} |x| \right| \leq \left(|x|^2 + \left(\frac{\varepsilon}{2}\right)^{\frac{-1}{q-2}} |x| \right) \\
&= \left(|x|^q |x|^{-(q-2)} + \left(\frac{\varepsilon}{2}\right)^{\frac{-1}{q-2}} |x|^q |x|^{-(q-1)} \right) \\
&\leq \left(|x|^q \left(\frac{\varepsilon}{2}\right)^{\frac{q-2}{q-2}} + \left(\frac{\varepsilon}{2}\right)^{\frac{-1}{q-2}} |x|^q \left(\frac{\varepsilon}{2}\right)^{\frac{q-1}{q-2}} \right) \\
&= \left(\frac{\varepsilon}{2} + \frac{\varepsilon}{2}\right) |x|^q = \varepsilon |x|^q \leq \varepsilon \max\{1, |x|^q\}
\end{aligned} \tag{6.1.35}$$

Note that (6.1.33), (6.1.30) and the fact that $\delta = 2^{\frac{-2}{q-2}} \varepsilon^{\frac{q}{q-2}}$ then tell for all $x \in \left[-\left(\frac{\varepsilon}{2}\right)^{\frac{-1}{q-2}}, \left(\frac{\varepsilon}{2}\right)^{\frac{-1}{q-2}}\right]$ it holds that:

$$\begin{aligned}
&|x^2 - (\mathfrak{J}_\tau(\Phi))(x)| \\
&= \left(\frac{\varepsilon}{2}\right)^{\frac{-2}{q-2}} \left| \left(\left(\frac{\varepsilon}{2}\right)^{\frac{1}{q-2}} x\right)^2 - \left([\mathfrak{J}_\tau(\Phi)]\left(\left(\frac{\varepsilon}{2}\right)^{\frac{1}{q-2}} x\right) + [\mathfrak{J}_\tau(\Phi)](-y)\right) \right| \\
&\leq \left(\frac{\varepsilon}{2}\right)^{\frac{-2}{q-2}} \left[\sup_{y \in [-1,1]} |y^2 - [\mathfrak{J}_\tau(\Phi)](y) + [\mathfrak{J}_\tau(\Phi)](-y)| \right] \\
&\leq \left(\frac{\varepsilon}{2}\right)^{\frac{-2}{q-2}} \delta = \left(\frac{\varepsilon}{2}\right)^{\frac{-2}{q-2}} 2^{\frac{-2}{q-2}} \varepsilon^{\frac{q}{q-2}} = \varepsilon \leq \varepsilon \max\{1, |x|^q\}
\end{aligned} \tag{6.1.36}$$

Now note that this and (6.1.35) tells us that for all $x \in \mathbb{R}$ it is the case that:

$$|x^2 - (\mathfrak{J}_\tau(\Psi))(x)| \leq \varepsilon \max\{1, |x|^q\} \tag{6.1.37}$$

This establishes Item (v). Note that, (6.1.36) tells that for all $x \in \left[-\left(\frac{\varepsilon}{2}\right)^{\frac{-1}{q-2}}, \left(\frac{\varepsilon}{2}\right)^{\frac{-1}{q-2}}\right]$ it is the case that:

$$|(\mathfrak{J}_\tau(\Psi))(x)| \leq |x^2 - (\mathfrak{J}_\tau(\Psi))(x)| + |x|^2 \leq \varepsilon + |x|^2 \tag{6.1.38}$$

This and (6.1.35) tells us that for all $x \in \mathbb{R}$:

$$|(\mathfrak{J}_\tau)(x)| \leq \varepsilon + |x|^2 \tag{6.1.39}$$

This establishes Item (iv).

Note next that by Corollary 5.5.5.1, Remark 5.5.2, the hypothesis, and the fact that $\delta = 2^{\frac{-2}{q-2}} \varepsilon^{\frac{q}{q-2}}$

tells us that:

$$\begin{aligned} D(\Psi) = D(\Phi) &\leq \max \left\{ \frac{1}{2} \log_2(\delta^{-1}) + 1, 2 \right\} \\ &= \max \left\{ \frac{1}{q-2} + \left\lceil \frac{q}{q-2} \right\rceil \log_2(\varepsilon) + 1, 2 \right\} \end{aligned} \quad (6.1.40)$$

This establishes Item (v).

Notice next that the fact that $\delta = 2^{\frac{-2}{q-2}} \varepsilon^{\frac{q}{q-2}}$ tells us that:

$$\log_2(\delta^{-1}) = \log_2 \left(2^{\frac{2}{q-2}} \varepsilon^{\frac{-q}{q-2}} \right) = \frac{2}{q-2} + \left\lceil \frac{q}{q-2} \right\rceil \log_2(\varepsilon^{-1}) \quad (6.1.41)$$

Note that by , Corollary 5.5.5.1 we have that:

$$P(\Phi \bullet \text{Aff}_{-\alpha,0}) \leq \left[\max \left\{ 1, \frac{I(\text{Aff}_{-\alpha,0}) + 1}{I(\Phi) + 1} \right\} \right] P(\Phi) = P(\Phi) \quad (6.1.42)$$

and further that:

$$\begin{aligned} P(\text{Aff}_{\alpha^{-2},0} \bullet \Phi \bullet \text{Aff}_{-\alpha,0}) &= \left[\max \left\{ 1, \frac{O(\text{Aff}_{-\alpha^2,0})}{O(\Phi \bullet \text{Aff}_{-\alpha,0})} \right\} \right] P(\Phi \bullet \text{Aff}_{-\alpha,0}) \\ &\leq P(\Phi) \end{aligned} \quad (6.1.43)$$

By symmetry note also that $P(\text{Aff}_{\alpha^{-2},0} \bullet \Phi \bullet \text{Aff}_{\alpha,0}) = P(\text{Aff}_{\alpha^{-2},0} \bullet \Phi \bullet \text{Aff}_{-\alpha,0})$ and also that $L(\text{Aff}_{\alpha^{-2},0} \bullet \Phi \bullet \text{Aff}_{\alpha,0}) = L(\text{Aff}_{\alpha^{-2},0} \bullet \Phi \bullet \text{Aff}_{-\alpha,0})$. Thus Lemma 5.6.9, Corollary 5.3.5.1, and the hypothesis tells us that:

$$\begin{aligned} P(\Psi) &= P(\Phi \boxplus \Phi) \\ &\leq 4P(\Phi) \\ &= 4 \max \{ 10 \log_2(\delta^{-1}) - 7, 13 \} \end{aligned} \quad (6.1.44)$$

This, and the fact that $\delta = 2^{\frac{-2}{q-2}} \varepsilon^{\frac{q}{q-2}}$ renders (6.1.44) as:

$$\begin{aligned}
4 \max \{10 \log_2 (\delta^{-1}) - 7, 13\} &= 4 \max \{10 \log_2 (\delta^{-1}) - 7, 13\} \\
&= 4 \max \left\{ 10 \left(\frac{2}{q-2} + \frac{q}{q-2} \log_2 (\varepsilon^{-1}) \right) - 7, 13 \right\} \\
&= \max \left\{ \left[\frac{40q}{q-2} \right] \log_2 (\varepsilon^{-1}) + \frac{80}{q-2} - 28, 52 \right\} \tag{6.1.45}
\end{aligned}$$

□

Remark 6.1.8. We will often find it helpful to refer to this network for fixed $\varepsilon \in (0, \infty)$ and $q \in (2, \infty)$ as the $\text{Sqr}^{q,\varepsilon}$ network.

Remark 6.1.9. For an R implementation see Listing 10.17

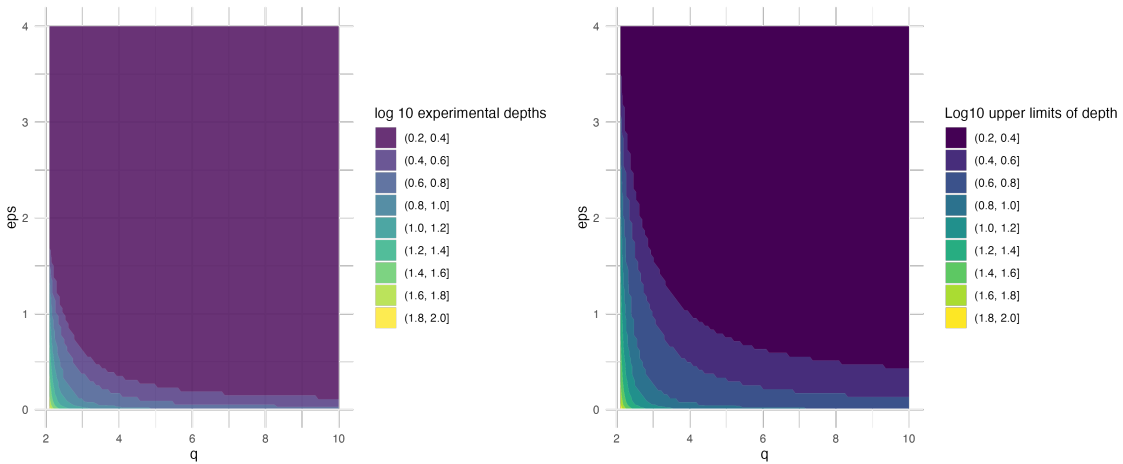

Figure 6.3: Left: \log_{10} of depths for a simulation with $q \in [2.1, 4]$, $\varepsilon \in (0.1, 2]$, and $x \in [-5, 5]$, all with 50 mesh-points. Right: The theoretical upper limits over the same range of values

	Min.	1 st Qu.	Median	Mean	3 rd Qu.	Max.
Experimental $ x^2 - \mathfrak{I}_\tau(\text{Sqr}^{q,\varepsilon})(x) $	0.000003	0.089438	0.337870	3.148933	4.674652	20.00
Theoretical $ x^2 - \mathfrak{I}_\tau(\text{Sqr}^{q,\varepsilon})(x) $	0.010	1.715	10.402	48.063	45.538	1250.00
Difference	0.001	1.6012	9.8655	44.9141	40.7102	1230

Table 6.1: Theoretical upper bounds for L^1 error, experimental L^1 error and their forward difference, with $q \in [2.1, 4]$, $\varepsilon \in (0.1, 2]$, and $x \in [-5, 5]$, all with 50 mesh-points.

6.1.3 The Prd network

We are finally ready to give neural network representations of arbitrary products of real numbers. However, this representation differs somewhat from those found in the literature, especially [Grohs et al. \(2023\)](#), where parallelization (stacking) is used instead of neural network sums. This will help us calculate W_1 and the width of the second to last layer.

Lemma 6.1.10. *Let $\delta, \varepsilon \in (0, \infty)$, $q \in (2, \infty)$, $A_1, A_2, A_3 \in \mathbb{R}^{1 \times 2}$, $\Psi \in \text{NN}$ satisfy for all $x \in \mathbb{R}$ that $\delta = \varepsilon (2^{q-1} + 1)^{-1}$, $A_1 = [1 \ 1]$, $A_2 = [1 \ 0]$, $A_3 = [0 \ 1]$, $\mathfrak{J}_\tau \in C(\mathbb{R}, \mathbb{R})$, $(\mathfrak{J}_\tau(\Psi))(0) = 0$, $0 \leq (\mathfrak{J}_\tau(\Psi))(x) \leq \delta + |x|^2$, $|x^2 - (\mathfrak{J}_\tau(\Psi))(x)| \leq \delta \max\{1, |x|^q\}$, $D(\Psi) \leq \max\{1 + \frac{1}{q-2} + \frac{q}{2(q-2)} \log_2(\delta^{-1}), 2\}$, and $P(\Psi) \leq \max\left\{\left\lceil \frac{40q}{q-2} \right\rceil \log_2(\delta^{-1}) + \frac{80}{q-2} - 28, 52\right\}$, then:*

(i) *there exists a unique $\Gamma \in \text{NN}$ satisfying:*

$$\Gamma = \left(\frac{1}{2} \triangleright (\Psi \bullet \text{Aff}_{A_1,0}) \right) \oplus \left(\left(-\frac{1}{2} \right) \triangleright (\Psi \bullet \text{Aff}_{A_2,0}) \right) \oplus \left(\left(-\frac{1}{2} \right) \triangleright (\Psi \bullet \text{Aff}_{A_3,0}) \right) \quad (6.1.46)$$

(ii) *it that $\mathfrak{J}_\tau(\Gamma) \in C(\mathbb{R}^2, \mathbb{R})$*

(iii) *it holds for all $x \in \mathbb{R}$ that $(\mathfrak{J}_\tau(\Gamma))(x, 0) = (\mathfrak{J}_\tau(\Gamma))(0, y) = 0$*

(iv) *it holds for any $x, y \in \mathbb{R}$ that $\left| xy - (\mathfrak{J}_\tau(\Gamma)) \left(\begin{bmatrix} x \\ y \end{bmatrix} \right) \right| \leq \varepsilon \max\{1, |x|^q, |y|^q\}$*

(v) *it holds that $P(\Gamma) \leq \frac{360q}{q-2} [\log_2(\varepsilon^{-1}) + q + 1] - 252$*

(vi) *it holds that $D(\Gamma) \leq \frac{q}{q-2} [\log_2(\varepsilon^{-1}) + q]$*

(vii) *it holds that $W_1(\Gamma) = 24$*

(viii) *it holds that $W_{H(\Gamma)} = 24$*

Proof. Note that:

$$\begin{aligned}
(\mathfrak{J}_\tau(\Gamma)) \left(\begin{bmatrix} x \\ y \end{bmatrix} \right) &= \mathfrak{J}_\tau \left(\left(\frac{1}{2} \triangleright (\Psi \bullet \text{Aff}_{A_1,0}) \right) \oplus \left(\left(-\frac{1}{2} \right) \triangleright (\Psi \bullet \text{Aff}_{A_2,0}) \right) \oplus \right. \\
&\quad \left. \left(\left(-\frac{1}{2} \right) \triangleright (\Psi \bullet \text{Aff}_{A_3,0}) \right) \right) \left(\begin{bmatrix} x \\ y \end{bmatrix} \right) \\
&= \mathfrak{J}_\tau \left(\frac{1}{2} \triangleright (\Psi \bullet \text{Aff}_{A_1,0}) \right) \left(\begin{bmatrix} x \\ y \end{bmatrix} \right) + \mathfrak{J}_\tau \left(\left(-\frac{1}{2} \right) \triangleright (\Psi \bullet \text{Aff}_{A_2,0}) \right) \left(\begin{bmatrix} x \\ y \end{bmatrix} \right) \\
&\quad + \mathfrak{J}_\tau \left(\left(-\frac{1}{2} \right) \triangleright (\Psi \bullet \text{Aff}_{A_3,0}) \right) \left(\begin{bmatrix} x \\ y \end{bmatrix} \right) \\
&= \frac{1}{2} (\mathfrak{J}_\tau(\Psi)) \left(\begin{bmatrix} 1 & 1 \\ 1 & 1 \end{bmatrix} \begin{bmatrix} x \\ y \end{bmatrix} \right) - \frac{1}{2} (\mathfrak{J}_\tau(\Psi)) \left(\begin{bmatrix} 1 & 0 \\ 1 & 0 \end{bmatrix} \begin{bmatrix} x \\ y \end{bmatrix} \right) \\
&\quad - \frac{1}{2} (\mathfrak{J}_\tau(\Psi)) \left(\begin{bmatrix} 0 & 1 \\ 1 & 1 \end{bmatrix} \begin{bmatrix} x \\ y \end{bmatrix} \right) \\
&= \frac{1}{2} (\mathfrak{J}_\tau(\Psi))(x+y) - \frac{1}{2} (\mathfrak{J}_\tau(\Psi))(x) - \frac{1}{2} (\mathfrak{J}_\tau(\Psi))(y)
\end{aligned} \tag{6.1.48}$$

Note that this, and the assumption that $(\mathfrak{J}_\tau(\Psi))(x) \in C(\mathbb{R}, \mathbb{R})$ and that $(\mathfrak{J}_\tau(\Psi))(0) = 0$ ensures:

$$\begin{aligned}
(\mathfrak{J}_\tau(\Gamma)) \left(\begin{bmatrix} x \\ 0 \end{bmatrix} \right) &= \frac{1}{2} (\mathfrak{J}_\tau(\Psi))(x+0) - \frac{1}{2} (\mathfrak{J}_\tau(\Psi))(x) - \frac{1}{2} (\mathfrak{J}_\tau(\Psi))(0) \\
&= 0 \\
&= \frac{1}{2} (\mathfrak{J}_\tau(\Psi))(0+y) - \frac{1}{2} (\mathfrak{J}_\tau(\Psi))(0) - \frac{1}{2} (\mathfrak{J}_\tau(\Psi))(y) \\
&= (\mathfrak{J}_\tau(\Gamma)) \left(\begin{bmatrix} 0 \\ y \end{bmatrix} \right)
\end{aligned} \tag{6.1.49}$$

Next, observe that since by assumption it is the case for all $x, y \in \mathbb{R}$ that $|x^2 - (\mathfrak{J}_\tau(\Psi))(x)| \leq$

$\delta \max\{1, |x|^q\}$, $xy = \frac{1}{2}|x+y|^2 - \frac{1}{2}|x|^2 - \frac{1}{2}|y|^2$, triangle Inequality and from (6.1.48) we have that:

$$\begin{aligned}
& |(\mathfrak{I}_\tau(\Gamma))(x, y) - xy| \\
&= \left| \frac{1}{2} [(\mathfrak{I}_\tau(\Psi))(x+y) - |x+y|^2] - \frac{1}{2} [(\mathfrak{I}_\tau(\Psi))(x) - |x|^2] - \frac{1}{2} [(\mathfrak{I}_\tau(\Psi))(x) - |y|^2] \right| \\
&\leq \left| \frac{1}{2} [(\mathfrak{I}_\tau(\Psi))(x+y) - |x+y|^2] + \frac{1}{2} [(\mathfrak{I}_\tau(\Psi))(x) - |x|^2] + \frac{1}{2} [(\mathfrak{I}_\tau(\Psi))(x) - |y|^2] \right| \\
&\leq \frac{\delta}{2} [\max\{1, |x+y|^q\} + \max\{1, |x|^q\} + \max\{1, |y|^q\}]
\end{aligned}$$

Note also that since for all $\alpha, \beta \in \mathbb{R}$ and $p \in [1, \infty)$ we have that $|\alpha + \beta|^p \leq 2^{p-1}(|\alpha|^p + |\beta|^p)$ we have that:

$$\begin{aligned}
& |(\mathfrak{I}_\tau(\Psi))(x) - xy| \\
&\leq \frac{\delta}{2} [\max\{1, 2^{q-1}|x|^q + 2^{q-1}|y|^q\} + \max\{1, |x|^q\} + \max\{1, |y|^q\}] \\
&\leq \frac{\delta}{2} [\max\{1, 2^{q-1}|x|^q\} + 2^{q-1}|y|^q + \max\{1, |x|^q\} + \max\{1, |y|^q\}] \\
&\leq \frac{\delta}{2} [2^q + 2] \max\{1, |x|^q, |y|^q\} = \varepsilon \max\{1, |x|^q, |y|^q\}
\end{aligned}$$

This proves Item (iv).

By symmetry it holds that $\mathbb{P}(\frac{1}{2} \triangleright (\Psi \bullet \text{Aff}_{A_1,0})) = \mathbb{P}(-\frac{1}{2} \triangleright (\Psi \bullet \text{Aff}_{A_2,0})) = \mathbb{P}(-\frac{1}{2} \triangleright (\Psi \bullet \text{Aff}_{A_3,0}))$ and further that $\mathbb{L}(\frac{1}{2} \triangleright (\Psi \bullet \text{Aff}_{A_1,0})) = \mathbb{L}(-\frac{1}{2} \triangleright (\Psi \bullet \text{Aff}_{A_2,0})) = \mathbb{L}(-\frac{1}{2} \triangleright (\Psi \bullet \text{Aff}_{A_3,0}))$. Note also that Corollary 5.5.5.1 tells us that for all $i \in \{1, 2, 3\}$ and $a \in \{\frac{1}{2}, -\frac{1}{2}\}$ it is the case that:

$$\mathbb{P}(a \triangleright (\Psi \bullet \text{Aff}_{A_i,0})) = \mathbb{P}(\Psi) \tag{6.1.50}$$

This, together with Corollary 5.6.9.1 indicates that:

$$\begin{aligned}
& \mathbb{P}(\Gamma) \leq 9 \mathbb{P}(\Psi) \\
&\leq 9 \max \left\{ \left\lceil \frac{40q}{q-2} \right\rceil \log_2(\delta^{-1}) + \frac{80}{q-2} - 28, 52 \right\}
\end{aligned} \tag{6.1.51}$$

Combined with the fact that $\delta = \varepsilon (2^{q-1} + 1)^{-1}$, this is then rendered as:

$$\begin{aligned} & 9 \max \left\{ \left[\frac{40q}{q-2} \right] \log_2 (\delta^{-1}) + \frac{80}{q-2} - 28, 52 \right\} \\ & = 9 \max \left\{ \left[\frac{40q}{q-2} \right] (\log_2 (\varepsilon^{-1}) + \log_2 (2^{q-1} + 1)) + \frac{80}{q-2} - 28, 52 \right\} \end{aligned} \quad (6.1.52)$$

Note that:

$$\begin{aligned} \log_2 (2^{q-1} + 1) & = \log_2 (2^{q-1} + 1) - \log_2 (2^q) + q \\ & = \log_2 \left(\frac{2^{q-1} + 1}{2^q} \right) + q = \log_2 (2^{-1} + 2^{-q}) + q \\ & \leq \log_2 (2^{-1} + 2^{-2}) + q = \log_2 \left(\frac{3}{4} \right) + q = \log_2 (3) - 2 + q \end{aligned} \quad (6.1.53)$$

Combine this with the fact that for all $q \in (2, \infty)$ it is the case that $\frac{q(q-1)}{q-2} \geq 2$ then gives us that:

$$\left[\frac{40q}{q-2} \right] \log_2 (2^{q-1} + 1) - 28 \geq \left[\frac{40q}{q-2} \right] \log_2 (2^{q-1}) - 28 = \frac{40q(q-1)}{q-2} - 28 \geq 52 \quad (6.1.54)$$

This then finally renders (6.1.52) as:

$$\begin{aligned} & 9 \max \left\{ \left[\frac{40q}{q-2} \right] (\log_2 (\varepsilon^{-1}) + \log_2 (2^{q-1} + 1)) + \frac{80}{q-2} - 28, 52 \right\} \\ & \leq 9 \left[\left[\frac{40q}{q-2} \right] (\log_2 (\varepsilon^{-1}) + \log_2 (3) - 2 + q) + \frac{80}{q-2} - 28 \right] \\ & = 9 \left[\left[\frac{40q}{q-2} \right] \left(\log_2 (\varepsilon^{-1}) + \log_2 (3) - 2 + \frac{2}{q} \right) - 28 \right] \\ & \leq 9 \left[\left[\frac{40q}{q-2} \right] (\log_2 (\varepsilon^{-1}) + \log_2 (3) - 1) - 28 \right] \\ & = \frac{360q}{q-2} [\log_2 (\varepsilon^{-1}) + q + \log_2 (3) - 1] - 252 \end{aligned} \quad (6.1.55)$$

Note that Lemma 5.6.10, Lemma 5.5.5, the hypothesis, and the fact that $\delta = \varepsilon (2^{q-1} + 1)^{-1}$ tell us

that:

$$\begin{aligned}
D(\Gamma) = D(\Psi) &\leq \max \left\{ 1 + \frac{1}{q-2} + \frac{q}{2(q-2)} \log_2(\delta^{-1}), 2 \right\} \\
&= \max \left\{ 1 + \frac{1}{q-2} + \frac{q}{2(q-2)} [\log_2(\varepsilon^{-1}) + \log_2(2^{q-1} + 1)], 2 \right\} \\
&= \max \left\{ 1 + \frac{1}{q-2} + \frac{q}{2(q-2)} (\log_2(\varepsilon^{-1}) + q - 1), 2 \right\} \tag{6.1.56}
\end{aligned}$$

Since it is the case that $\frac{q(q-1)}{2(q-2)} > 2$ for $q \in (2, \infty)$ we have that:

$$\begin{aligned}
&\max \left\{ 1 + \frac{1}{q-2} + \frac{q}{2(q-2)} (\log_2(\varepsilon^{-1}) + q - 1), 2 \right\} \\
&= 1 + \frac{1}{q-2} + \frac{q}{2(q-2)} (\log_2(\varepsilon^{-1}) + q - 1) \\
&\leq \frac{q-1}{q-2} + \frac{q}{2(q-2)} (\log_2(\varepsilon^{-1}) + q) \tag{6.1.57}
\end{aligned}$$

Observe next that for $q \in (0, \infty)$, $\varepsilon \in (0, \infty)$, Γ consists of, among other things, three stacked $(\Psi \bullet \text{Aff}_{A_i,0})$ networks where $i \in \{1, 2, 3\}$. Corollary 5.5.5.1 tells us therefore, that $W_1(\Gamma) = 3 \cdot W_1(\Psi)$. On the other hand, note that each Ψ networks consist of, among other things, two stacked Φ networks, which by Corollary 5.5.5.1 and Lemma 6.1.7, yields that $W_1(\Gamma) = 6 \cdot W_1(\Phi)$. Finally from Corollary 6.1.4.1, and Corollary 5.5.5.1, we see that the only thing contributing to the $W_1(\Phi)$ is $W_1(i_4)$, which was established from Lemma 6.1.2 as 4. Whence we get that $W_1(\Gamma) = 6 \cdot 4 = 24$, and that $W_{H(\Gamma)}(\Gamma) = 24$. This proves Item (vii)—(viii). This then completes the proof of the Lemma. \square

Corollary 6.1.10.1. *Let $\delta, \varepsilon \in (0, \infty)$, $q \in (2, \infty)$, $A_1, A_2, A_3 \in \mathbb{R}^{1 \times 2}$, $\Psi \in \mathbb{N}$ satisfy for all $x \in \mathbb{R}$ that $\delta = \varepsilon(2^{q-1} + 1)^{-1}$, $A_1 = [1 \ 1]$, $A_2 = [1 \ 0]$, $A_3 = [0 \ 1]$, $\mathfrak{J}_\tau \in C(\mathbb{R}, \mathbb{R})$, $(\mathfrak{J}_\tau(\Psi))(0) = 0$, $0 \leq (\mathfrak{J}_\tau(\Psi))(x) \leq \delta + |x|^2$, $|x^2 - (\mathfrak{J}_\tau(\Psi))(x)| \leq \delta \max\{1, |x|^q\}$, $D(\Psi) \leq \max\{1 + \frac{1}{q-2} + \frac{q}{2(q-2)} \log_2(\delta^{-1}), 2\}$, and $P(\Psi) \leq \max\left\{\left\lceil \frac{40q}{q-2} \right\rceil \log_2(\delta^{-1}) + \frac{80}{q-2} - 28, 52\right\}$, and finally let Γ be defined as in Lemma 6.1.10, i.e.:*

$$\Gamma = \left(\frac{1}{2} \otimes (\Psi \bullet \text{Aff}_{A_1,0}) \right) \oplus \left(\left(-\frac{1}{2} \right) \otimes (\Psi \bullet \text{Aff}_{A_2,0}) \right) \oplus \left(\left(-\frac{1}{2} \right) \otimes (\Psi \bullet \text{Aff}_{A_3,0}) \right) \tag{6.1.58}$$

It is then the case for all $x, y \in \mathbb{R}$ that:

$$\mathfrak{J}_\tau(\Gamma)(x, y) \leq \frac{3}{2} \left(\frac{\varepsilon}{3} + x^2 + y^2 \right) \leq \varepsilon + 2x^2 + 2y^2 \quad (6.1.59)$$

Proof. Note that the triangle inequality, the fact that $\delta = \varepsilon(2^{q-1} + 1)^{-1}$, the fact that for all $x, y \in \mathbb{R}$ it is the case that $|x + y|^2 \leq 2(|x|^2 + |y|^2)$ and (6.1.48) tell us that:

$$\begin{aligned} |\mathfrak{J}_\tau(\Gamma)(x, y)| &\leq \frac{1}{2} |\mathfrak{J}_\tau(\Psi)(x + y)| + \frac{1}{2} |\mathfrak{J}_\tau(\Psi)(x)| + \frac{1}{2} |\mathfrak{J}_\tau(\Psi)(y)| \\ &\leq \frac{1}{2} (\delta + |x + y|^2) + \frac{1}{2} (\delta + |x|^2) + \frac{1}{2} (\delta + |y|^2) \\ &\leq \frac{3\delta}{2} + \frac{3}{2} (|x|^2 + |y|^2) = \left(\frac{3\varepsilon}{2} \right) (2^{q-1} + 1)^{-1} + \frac{3}{2} (|x|^2 + |y|^2) \\ &= \frac{3}{2} \left(\frac{\varepsilon}{2^{q-1} + 1} + |x|^2 + |y|^2 \right) \leq \frac{3}{2} \left(\frac{\varepsilon}{3} + |x|^2 + |y|^2 \right) \\ &\leq \varepsilon + 2x^2 + 2y^2 \end{aligned} \quad (6.1.60)$$

□

Remark 6.1.11. We shall refer to this neural network for a given $q \in (2, \infty)$ and given $\varepsilon \in (0, \infty)$ from now on as $\text{Prd}^{q, \varepsilon}$.

Remark 6.1.12. For an R implementation see Listing ??

Remark 6.1.13. Diagrammatically, this can be represented as:

6.2 Higher Approximations

We take inspiration from the Sum neural network to create the Prd neural network. However, we first need to define a special neural network called *tunneling neural network* to stack two neural networks not of the same length effectively.

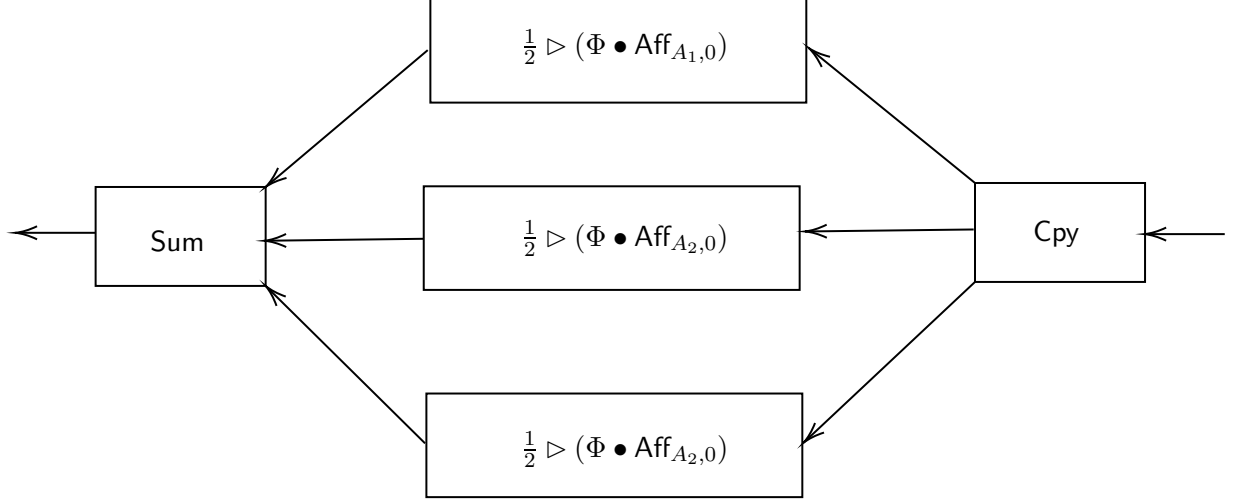

Figure 6.4: A neural network diagram of the Sqr.

6.2.1 The Tun Neural Networks and Their Properties

Definition 6.2.1 (R—,2023, The Tunneling Neural Networks). *We define the tunneling neural network, denoted as Tun_n for $n \in \mathbb{N}$ by:*

$$\text{Tun}_n = \begin{cases} \text{Aff}_{1,0} & : n = 1 \\ \text{Id}_1 & : n = 2 \\ \bullet^{n-2} \text{Id}_1 & n \in \mathbb{N} \cap [3, \infty) \end{cases} \quad (6.2.1)$$

Where Id_1 is as in Definition 8.1.1.

Remark 6.2.2. *For an R implementation see Listing 10.12*

Lemma 6.2.3. *Let $n \in \mathbb{N}$, $x \in \mathbb{R}$ and $\text{Tun}_n \in \text{NN}$. For all $n \in \mathbb{N}$ and $x \in \mathbb{R}$, it is then the case that:*

(i) $\mathfrak{J}_\tau(\text{Tun}_n) \in C(\mathbb{R}, \mathbb{R})$

(ii) $D(\text{Tun}_n) = n$

(iii) $(\mathfrak{J}_\tau(\text{Tun}_n))(x) = x$

$$(iv) \text{ P}(\text{Tun}_n) = \begin{cases} 2 & : n = 1 \\ 7 + 6(n - 2) & : n \in \mathbb{N} \cap [2, \infty) \end{cases}$$

$$(v) \text{ L}(\text{Tun}_n) = (l_0, l_1, \dots, l_{L-1}, l_L) = (1, 2, \dots, 2, 1)$$

Proof. Note that $\text{Aff}_{0,1} \in C(\mathbb{R}, \mathbb{R})$ and by Lemma 8.1.2 we have that $\text{Id}_1 \in C(\mathbb{R}, \mathbb{R})$. Finally, the composition of continuous functions is continuous, hence $\text{Tun}_n \in C(\mathbb{R}, \mathbb{R})$ for $n \in \mathbb{N} \cap [2, \infty)$. This proves Item (i).

Note that by Lemma 5.5.2 it is the case that $D(\text{Aff}_{1,0}) = 1$ and by Lemma 8.1.1 it is the case that $D(\text{Id}_1) = 2$. Assume now that for all $n \leq N$ that $D(\text{Tun}_n) = n$, then for the inductive step, by Lemma 5.2.5 we have that:

$$\begin{aligned} D(\text{Tun}_{n+1}) &= D(\bullet^{n-1} \text{Id}_1) \\ &= D((\bullet^{n-2} \text{Id}_1) \bullet \text{Id}_1) \\ &= n + 2 - 1 = n + 1 \end{aligned} \tag{6.2.2}$$

This completes the induction and proves Item (i)—(iii). Note next that by (5.1.10) we have that:

$$(\mathfrak{J}_\tau(\text{Aff}_{1,0}))(x) = x \tag{6.2.3}$$

Lemma 8.1.2, Item (iii) also tells us that:

$$(\mathfrak{J}_\tau(\text{Id}_1))(x) = \mathfrak{r}(x) - \mathfrak{r}(-x) = x \tag{6.2.4}$$

Assume now that for all $n \leq N$ that $\text{Tun}_n(x) = x$. For the inductive step, by Lemma 8.1.2, Item

(iii), and we then have that:

$$\begin{aligned}
(\mathfrak{J}_\tau(\mathbf{Tun}_{n+1}))(x) &= (\mathfrak{J}_\tau(\bullet^{n-1} \mathbf{Id}_1))(x)(x) \\
&= (\mathfrak{J}_\tau((\bullet^{n-2} \mathbf{Id}_1) \bullet \mathbf{Id}_1)) \\
&= ((\mathfrak{J}_\tau(\bullet^{n-2} \mathbf{Id}_1)) \circ (\mathfrak{J}_\tau(\mathbf{Id}_1)))(x) \\
&= ((\mathfrak{J}_\tau(\mathbf{Tun}_n)) \circ (\mathfrak{J}_\tau(\mathbf{Id}_1)))(x) \\
&= x
\end{aligned} \tag{6.2.5}$$

This proves Item (ii). Next note that $P(\mathbf{Tun}_1) = P(\mathbf{Aff}_{1,0}) = 2$. Note also that:

$$\begin{aligned}
P(\mathbf{Tun}_2) &= P(\mathbf{Id}_1) = P \left[\left(\left(\left[\begin{array}{c} 1 \\ -1 \end{array} \right], \left[\begin{array}{c} 0 \\ 0 \end{array} \right] \right), \left(\left[\begin{array}{cc} 1 & -1 \end{array} \right], \left[\begin{array}{c} 0 \\ 0 \end{array} \right] \right) \right) \right] \\
&= 7
\end{aligned}$$

And that by definition of composition:

$$\begin{aligned}
P(\mathbf{Tun}_3) &= P \left[\left(\left(\left(\left[\begin{array}{c} 1 \\ -1 \end{array} \right], \left[\begin{array}{c} 0 \\ 0 \end{array} \right] \right), \left(\left[\begin{array}{cc} 1 & -1 \end{array} \right], \left[\begin{array}{c} 0 \\ 0 \end{array} \right] \right) \right) \bullet \left(\left(\left[\begin{array}{c} 1 \\ -1 \end{array} \right], \left[\begin{array}{c} 0 \\ 0 \end{array} \right] \right), \left(\left[\begin{array}{cc} 1 & -1 \end{array} \right], \left[\begin{array}{c} 0 \\ 0 \end{array} \right] \right) \right) \right) \right] \\
&= P \left[\left(\left(\left[\begin{array}{c} 1 \\ -1 \end{array} \right], \left[\begin{array}{c} 0 \\ 0 \end{array} \right] \right), \left(\left[\begin{array}{cc} 1 & -1 \\ -1 & 1 \end{array} \right], \left[\begin{array}{c} 0 \\ 0 \end{array} \right] \right), \left(\left[\begin{array}{cc} 1 & -1 \end{array} \right], \left[\begin{array}{c} 0 \\ 0 \end{array} \right] \right) \right) \right] \\
&= 13
\end{aligned}$$

Now for the inductive step assume that for all $n \leq N \in \mathbb{N}$, it is the case that $P(\mathbf{Tun}_n) = 7 + 6(n-2)$.

For the inductive step, we then have:

$$\begin{aligned}
\mathbf{P}(\mathbf{Tun}_{n+1}) &= \mathbf{P}(\mathbf{Tun}_n \bullet \mathbf{Id}_1) \\
&= \mathbf{P} \left[\left(\left(\left(\begin{bmatrix} 1 \\ -1 \end{bmatrix}, \begin{bmatrix} 0 \\ 0 \end{bmatrix} \right), \left(\begin{bmatrix} 1 & -1 \\ -1 & 1 \end{bmatrix}, \begin{bmatrix} 0 \\ 0 \end{bmatrix} \right), \dots, \left(\begin{bmatrix} 1 & -1 \\ -1 & 1 \end{bmatrix}, \begin{bmatrix} 0 \\ 0 \end{bmatrix} \right) \right) \bullet \mathbf{Id}_1 \right] \\
&= \mathbf{P} \left[\left(\left(\left(\begin{bmatrix} 1 \\ -1 \end{bmatrix}, \begin{bmatrix} 0 \\ 0 \end{bmatrix} \right), \left(\begin{bmatrix} 1 & -1 \\ -1 & 1 \end{bmatrix}, \begin{bmatrix} 0 \\ 0 \end{bmatrix} \right), \dots, \left(\begin{bmatrix} 1 & -1 \\ -1 & 1 \end{bmatrix}, \begin{bmatrix} 0 \\ 0 \end{bmatrix} \right), \left(\begin{bmatrix} 1 & -1 \\ -1 & 1 \end{bmatrix}, \begin{bmatrix} 0 \\ 0 \end{bmatrix} \right) \right) \right] \\
&= 7 + 6(n-2) + 6 = 7 + 6((n+1) - 2) \tag{6.2.6}
\end{aligned}$$

This proves Item (iv).

Note finally that Item (v) is a consequence of Lemma 8.1.2, Item (i), and Lemma 5.2.5 \square

Definition 6.2.4 (R—, 2023, The Multi-dimensional Tunneling Network). *We define the multi-dimensional tunneling neural network, denoted as \mathbf{Tun}_n^d for $n \in \mathbb{N}$ and $d \in \mathbb{N}$ by:*

$$\mathbf{Tun}_n^d = \begin{cases} \mathbf{Aff}_{\mathbb{I}_d, 0_d} & : n = 1 \\ \mathbf{Id}_d & : n = 2 \\ \bullet^{n-2} \mathbf{Id}_d & : n \in \mathbb{N} \cap [3, \infty) \end{cases} \tag{6.2.7}$$

Where \mathbf{Id}_d is as in Definition 8.1.1.

Remark 6.2.5. *We may drop the requirement for a d and write \mathbf{Tun}_n where $d = 1$, and it is evident from the context.*

Lemma 6.2.6. *Let $n \in \mathbb{N}$, $d \in \mathbb{N}$, $x \in \mathbb{R}$ and $\mathbf{Tun}_n^d \in \mathbf{NN}$. For all $n \in \mathbb{N}$, $d \in \mathbb{N}$, and $x \in \mathbb{R}$, it is then the case that:*

$$(i) \mathfrak{J}_\tau(\mathbf{Tun}_n^d) \in C(\mathbb{R}, \mathbb{R})$$

$$(ii) \mathbf{D}(\mathbf{Tun}_n^d) = n$$

$$(iii) (\mathfrak{J}_\tau(\mathbf{Tun}_n^d))(x) = x$$

$$(iv) \text{ P}(\text{Tun}_n^d) = \begin{cases} 8d^2 + 5d & : n = 1 \\ 4d^2 + 3d + (n-1)(4d^2 + 2d) & : n \in \mathbb{N} \cap [2, \infty) \end{cases}$$

$$(v) \text{ L}(\text{Tun}_n^d) = (l_0, l_1, \dots, l_{L-1}, l_L) = (d, 2d, \dots, 2d, d)$$

Proof. Note that Items (i)–(iii) are consequences of Lemma 8.1.2 and Lemma 5.2.5 respectively.

Note now that by observation $\text{P}(\text{Tun}_1^d) = d^2 + d$. Next Lemma 8.1.4 tells us that $\text{P}(\text{Tun}_2^d) = 4d^2 + 3d$

Note also that by definition of neural network composition, we have the following:

$$\text{P}(\text{Tun}_3^d) \tag{6.2.8}$$

$$= \text{P} \left[\left(\left(\left(\begin{bmatrix} 1 \\ -1 \\ \vdots \\ 1 \\ -1 \end{bmatrix}, \begin{bmatrix} 0 \\ 0 \\ \vdots \\ 0 \\ 0 \end{bmatrix} \right), \left(\begin{bmatrix} 1 & -1 & & \\ & & \ddots & \\ & & & 1 & -1 \end{bmatrix}, \begin{bmatrix} 0 \\ \vdots \\ 0 \end{bmatrix} \right) \right) \right) \bullet \tag{6.2.9}$$

$$\left[\left(\left(\begin{bmatrix} 1 \\ -1 \\ \vdots \\ 1 \\ -1 \end{bmatrix}, \begin{bmatrix} 0 \\ 0 \\ \vdots \\ 0 \\ 0 \end{bmatrix} \right), \left(\begin{bmatrix} 1 & -1 & & \\ & & \ddots & \\ & & & 1 & -1 \end{bmatrix}, \begin{bmatrix} 0 \\ \vdots \\ 0 \end{bmatrix} \right) \right) \right]$$

$$= \text{P} \left[\left(\left(\left(\begin{bmatrix} 1 \\ -1 \\ \vdots \\ 1 \\ -1 \end{bmatrix}, \begin{bmatrix} 0 \\ 0 \\ \vdots \\ 0 \\ 0 \end{bmatrix} \right), \left(\begin{bmatrix} 1 & -1 & & \\ -1 & 1 & & \\ & & \ddots & \\ & & & 1 & -1 \\ & & & -1 & 1 \end{bmatrix}, \begin{bmatrix} 0 \\ 0 \\ \vdots \\ 0 \\ 0 \end{bmatrix} \right), \left(\begin{bmatrix} 1 & -1 & & \\ & & \ddots & \\ & & & 1 & -1 \end{bmatrix}, \begin{bmatrix} 0 \\ \vdots \\ 0 \end{bmatrix} \right) \right) \right]$$

$$= 2d \times d + 2d + 2d \times 2d + 2d + 2d \times d + d$$

$$= 2d^2 + 2d + 4d^2 + 2d + 2d^2 + d$$

$$= 8d^2 + 5d \tag{6.2.10}$$

Suppose now that for all naturals up to and including n , it is the case that $\text{P}(\text{Tun}_n^d) = 4d^2 + 3d +$

$(n - 2) (4d^2 + 2d)$. For the inductive step, we have the following:

$$\begin{aligned}
& \mathbb{P} \left(\text{Tun}_{n+1}^d \right) = \mathbb{P} \left(\text{Tun}_n^d \bullet \text{Id}_d \right) \\
& = \mathbb{P} \left[\left(\begin{bmatrix} 1 & & & \\ & -1 & & \\ & & \ddots & \\ & & & 1 \\ & & & & -1 \end{bmatrix}, \begin{bmatrix} 0 \\ 0 \\ \vdots \\ 0 \\ 0 \end{bmatrix} \right), \left(\begin{bmatrix} 1 & -1 & & \\ & -1 & 1 & \\ & & \ddots & \\ & & & 1 & -1 \\ & & & & -1 & 1 \end{bmatrix}, \begin{bmatrix} 0 \\ 0 \\ \vdots \\ 0 \\ 0 \end{bmatrix} \right), \dots, \left(\begin{bmatrix} 1 & -1 & & \\ & & \ddots & \\ & & & 1 & -1 \end{bmatrix}, \begin{bmatrix} 0 \\ \vdots \\ 0 \end{bmatrix} \right) \right. \\
& \quad \left. \bullet \text{Id}_d \right] \\
& = \mathbb{P} \left[\left(\begin{bmatrix} 1 & & & \\ & -1 & & \\ & & \ddots & \\ & & & 1 \\ & & & & -1 \end{bmatrix}, \begin{bmatrix} 0 \\ 0 \\ \vdots \\ 0 \\ 0 \end{bmatrix} \right), \left(\begin{bmatrix} 1 & -1 & & \\ & -1 & 1 & \\ & & \ddots & \\ & & & 1 & -1 \\ & & & & -1 & 1 \end{bmatrix}, \begin{bmatrix} 0 \\ 0 \\ \vdots \\ 0 \\ 0 \end{bmatrix} \right), \dots, \left(\begin{bmatrix} 1 & -1 & & \\ & -1 & 1 & \\ & & \ddots & \\ & & & 1 & -1 \\ & & & & -1 & 1 \end{bmatrix}, \begin{bmatrix} 0 \\ 0 \\ \vdots \\ 0 \\ 0 \end{bmatrix} \right), \right. \\
& \quad \left. \left(\begin{bmatrix} 1 & -1 & & \\ & & \ddots & \\ & & & 1 & -1 \end{bmatrix}, \begin{bmatrix} 0 \\ \vdots \\ 0 \end{bmatrix} \right) \right] \\
& = 4d^2 + 3d + (n - 2) (4d^2 + 2d) + 4d^2 + 2d \\
& = 4d^2 + 3d + (n - 1) (4d^2 + 2d)
\end{aligned}$$

This proves Item (iv). Finally, Item (v) is a consequence of Lemma 5.5.2 □

6.2.2 The Pwr Neural Networks and Their Properties

Definition 6.2.7 (R—, 2023, The Power Neural Network). *Let $n \in \mathbb{N}$. Let $\delta, \varepsilon \in (0, \infty)$, $q \in (2, \infty)$, satisfy that $\delta = \varepsilon (2^{q-1} + 1)^{-1}$. We define the power neural networks $\text{Pwr}_n^{q, \varepsilon} \in \text{NN}$, denoted for*

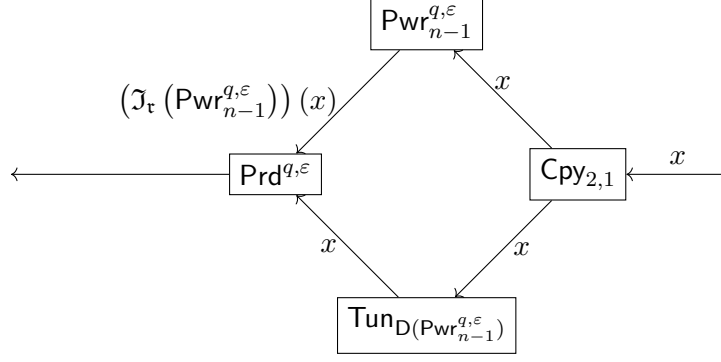

Figure 6.5: A representation of a typical $\text{Pwr}_n^{q,\varepsilon}$ network.

$n \in \mathbb{N}_0$ as:

$$\text{Pwr}_n^{q,\varepsilon} = \begin{cases} \text{Aff}_{0,1} & : n = 0 \\ \text{Prd}^{q,\varepsilon} \bullet \left[\text{Tun}_D(\text{Pwr}_{n-1}^{q,\varepsilon}) \boxplus \text{Pwr}_{n-1}^{q,\varepsilon} \right] \bullet \text{Cpy}_{2,1} & : n \in \mathbb{N} \end{cases}$$

Diagrammatically, this can be represented as:

Remark 6.2.8. For an R implementation see Listing 10.19

Remark 6.2.9. Note that for all $i \in \mathbb{N}$, $q \in (2, \infty)$, $\varepsilon \in (0, \infty)$, each $\text{Pwr}_i^{q,\varepsilon}$ differs from $\text{Pwr}_{i+1}^{q,\varepsilon}$ by atleast one $\text{Prd}^{q,\varepsilon}$ network.

Lemma 6.2.10. Let $x, y \in \mathbb{R}$, $\varepsilon \in (0, \infty)$ and $q \in (2, \infty)$. It is then the case for all $x, y \in \mathbb{R}$ that:

$$\varepsilon \max \{1, |x|^q, |y|^q\} \leq \varepsilon + \varepsilon|x|^q + \varepsilon|y|^q. \quad (6.2.11)$$

Proof. We will do this in the following cases:

For the case that $|x| \leq 1$ and $|y| \leq 1$ we then have:

$$\varepsilon \max \{1, |x|^q, |y|^q\} = \varepsilon \leq \varepsilon + \varepsilon|x|^q + \varepsilon|y|^q \quad (6.2.12)$$

For the case that $|x| \leq 1$ and $|y| \geq 1$, without loss of generality we have then:

$$\varepsilon \max \{1, |x|^q, |y|^q\} \leq \varepsilon|y|^q \leq \varepsilon + \varepsilon|x|^q + \varepsilon|y|^q : \quad (6.2.13)$$

For the case that $|x| \geq 1$ and $|y| \geq 1$, and without loss of generality that $|x| \geq |y|$ we have that:

$$\varepsilon \max\{1, |x|^q, |y|^q\} = \varepsilon |x|^q \leq \varepsilon + \varepsilon |x|^q + \varepsilon |y|^q \quad (6.2.14)$$

□

Lemma 6.2.11. *Let \mathfrak{p}_i for $i \in \{1, 2, \dots\}$ be the set of functions defined for $\varepsilon \in (0, \infty)$, and $x \in \mathbb{R}$ as follows:*

$$\begin{aligned} \mathfrak{p}_1 &= \varepsilon + 2 + 2|x|^2 \\ \mathfrak{p}_i &= \varepsilon + 2(\mathfrak{p}_{i-1})^2 + 2|x|^2 \text{ for } i \geq 2 \end{aligned} \quad (6.2.15)$$

For all $n \in \mathbb{N}$ and $\varepsilon \in (0, \infty)$ and $q \in (2, \infty)$ it holds for all $x \in \mathbb{R}$ that:

$$|\mathfrak{J}_\tau(\text{Pwr}_n^{q,\varepsilon})(x)| \leq \mathfrak{p}_n \quad (6.2.16)$$

Proof. Note that by Corollary 6.1.10.1 it is the case that:

$$|\mathfrak{J}_\tau(\text{Pwr}_1^{q,\varepsilon})(x)| = |\mathfrak{J}_\tau(\text{Prd}^{q,\varepsilon})(1, x)| \leq \mathfrak{p}_1 \quad (6.2.17)$$

and applying (6.2.17) twice, it is the case that:

$$\begin{aligned} |\mathfrak{J}_\tau(\text{Pwr}_2^{q,\varepsilon})(x)| &= |\mathfrak{J}_\tau(\text{Prd}^{q,\varepsilon})(\mathfrak{J}_\tau(\text{Prd}^{q,\varepsilon})(1, x), x)| \\ &\leq \varepsilon + 2|\mathfrak{J}_\tau(\text{Prd}^{q,\varepsilon})(1, x)|^2 + 2|x|^2 \\ &\leq \varepsilon + 2\mathfrak{p}_1^2 + 2|x|^2 = \mathfrak{p}_2 \end{aligned} \quad (6.2.18)$$

Let's assume this holds for all cases up to and including n . For the inductive step, Corollary 6.1.10.1

tells us that:

$$\begin{aligned}
|\mathfrak{J}_\tau(\text{Pwr}_{n+1}^{q,\varepsilon})(x)| &\leq |\mathfrak{J}_\tau(\text{Prd}^{q,\varepsilon}(\mathfrak{J}_\tau(\text{Prd}^{q,\varepsilon}(\mathfrak{J}_\tau \cdots (1,x),x),x) \cdots))| \\
&\leq \mathfrak{J}_\tau[\text{Prd}^{q,\varepsilon}(\text{Pwr}_n^{q,\varepsilon}(x),x)] \\
&\leq \varepsilon + 2\mathfrak{p}_n^2 + 2|x|^2 = \mathfrak{p}_{n+1}
\end{aligned} \tag{6.2.19}$$

This completes the proof of the lemma. \square

Remark 6.2.12. Note that since any instance of \mathfrak{p}_i contains an instance of \mathfrak{p}_{i-1} for $i \in \mathbb{N} \cap [2, \infty)$, we have that $\mathfrak{p}_n \in \mathcal{O}(\varepsilon^{2(n-1)})$

Lemma 6.2.13. For all $n \in \mathbb{N}$, $q \in (2, \infty)$, and $\varepsilon \in (0, \infty)$, it is the case that $\text{P}(\text{Tun}_{\text{D}(\text{Pwr}_n^{q,\varepsilon})}) \leq \text{P}(\text{Pwr}_n^{q,\varepsilon})$.

Proof. Note that for all $n \in \mathbb{N}$ it is straightforwardly the case that $\text{P}(\text{Pwr}_n^{q,\varepsilon}) \geq \text{P}(\text{Tun}_{\text{D}(\text{Pwr}_{n-1}^{q,\varepsilon})})$ because for all $n \in \mathbb{N}$, a $\text{Pwr}_n^{q,\varepsilon}$ network contains a $\text{Tun}_{\text{D}(\text{Pwr}_{n-1}^{q,\varepsilon})}$ network. Note now that for all $i \in \mathbb{N}$ we have from Lemma 6.2.3 that $5 \leq \text{P}(\text{Tun}_{i+1}) - \text{P}(\text{Tun}_i) \leq 6$. Recall from Corollary 6.1.4.1 that every instance of the Φ network contains atleast one \mathfrak{i}_4 network, which by Lemma 6.1.2 has 40 parameters, whence the $\text{Prd}^{q,\varepsilon}$ network has atleast 40 parameters for all $\varepsilon \in (0, \infty)$ and $q \in (2, \infty)$. Note now that for all $i \in \mathbb{N}$, $\text{Pwr}_i^{q,\varepsilon}$ and $\text{Pwr}_{i+1}^{q,\varepsilon}$ differ by atleast as many parameters as there are in $\text{Prd}^{q,\varepsilon}$, since, indeed, they differ by atleast one more $\text{Prd}^{q,\varepsilon}$. Thus for every increment in i , $\text{Pwr}_i^{q,\varepsilon}$ outstrips Tun_i by at-least $40 - 6 = 34$ parameters. This is true for all $i \in \mathbb{N}$. Whence it is the case that for all $i \in \mathbb{N}$, it is the case that $\text{P}(\text{Tun}_i) \leq \text{P}(\text{Pwr}_i^{q,\varepsilon})$. \square

Lemma 6.2.14 (R—,2023). Let $\delta, \varepsilon \in (0, \infty)$, $q \in (2, \infty)$, and $\delta = \varepsilon(2^{q-1} + 1)^{-1}$. Let $n \in \mathbb{N}_0$, and $\text{Pwr}_n \in \text{NN}$. It is then the case for all $n \in \mathbb{N}_0$, and $x \in \mathbb{R}$ that:

$$\begin{aligned}
(i) \quad &(\mathfrak{J}_\tau(\text{Pwr}_n^{q,\varepsilon}))(x) \in C(\mathbb{R}, \mathbb{R}) \\
(ii) \quad &\text{D}(\text{Pwr}_n^{q,\varepsilon}) \leq \begin{cases} 1 & : n = 0 \\ n \left[\frac{q}{q-2} [\log_2(\varepsilon^{-1}) + q] - 1 \right] + 1 & : n \in \mathbb{N} \end{cases} \\
(iii) \quad &W_1(\text{Pwr}_n^{q,\varepsilon}) = \begin{cases} 1 & : n = 0 \\ 24 + 2(n-1) & : n \in \mathbb{N} \end{cases}
\end{aligned}$$

$$(iv) \ P(\text{Pwr}_n^{q,\varepsilon}) \leq \begin{cases} 2 & : n = 0 \\ 4^{n+\frac{3}{2}} + \left(\frac{4^{n+1}-1}{3}\right) \left(\frac{360q}{q-2} [\log_2(\varepsilon^{-1}) + q + 1] + 372\right) & : n \in \mathbb{N} \end{cases}$$

$$(v) \ |x^n - (\mathfrak{J}_\tau(\text{Pwr}_n^{q,\varepsilon}))(x)| \leq \begin{cases} 0 & : n = 0 \\ |x(x^{n-1} - \mathfrak{J}_\tau(\text{Pwr}_{n-1}^{q,\varepsilon})(x))| + \varepsilon + |x|^q + \mathfrak{p}_{n-1}^q & : n \in \mathbb{N} \end{cases}$$

Where we let \mathfrak{p}_i for $i \in \{1, 2, \dots\}$ be the set of functions defined as follows:

$$\begin{aligned} \mathfrak{p}_1 &= \varepsilon + 2 + 2|x|^2 \\ \mathfrak{p}_i &= \varepsilon + 2(\mathfrak{p}_{i-1})^2 + 2|x|^2 \end{aligned} \tag{6.2.20}$$

And whence we get that:

$$|x^n - \mathfrak{J}_\tau(\text{Pwr}_n^{q,\varepsilon})(x)| \in \mathcal{O}\left(\varepsilon^{2q(n-1)}\right) \text{ for } n \geq 2 \tag{6.2.21}$$

$$(vi) \ W_{\text{H}(\text{Pwr}_n^{q,\varepsilon})}(\text{Pwr}_n^{q,\varepsilon}) = \begin{cases} 1 & n = 0 \\ 24 & n \in \mathbb{N} \end{cases}$$

Proof. Note that Item (ii) of Lemma 5.5.2 ensures that $\mathfrak{J}_\tau(\text{Pwr}_0) = \text{Aff}_{1,0} \in C(\mathbb{R}, \mathbb{R})$. Note next that by Item (v) of Lemma 5.2.5, with $\Phi_1 \curvearrowright \nu_1, \Phi_2 \curvearrowright \nu_2, a \curvearrowright \tau$, we have that:

$$(\mathfrak{J}_\tau(\nu_1 \bullet \nu_2))(x) = ((\mathfrak{J}_\tau(\nu_1)) \circ (\mathfrak{J}_\tau(\nu_2)))(x) \tag{6.2.22}$$

This, with the fact that the composition of continuous functions is continuous, the fact the stacking of continuous instantiated neural networks is continuous tells us that $(\mathfrak{J}_\tau \text{Pwr}_n) \in C(\mathbb{R}, \mathbb{R})$ for $n \in \mathbb{N} \cap [2, \infty)$. This establishes Item (i).

Note next that by observation $D(\text{Pwr}_0^{q,\varepsilon}) = 1$ and by Item (iv) of Lemma 8.1.2, it is the case that $D(\text{Id}_1) = 2$. By Lemmas 5.6.3 and 5.2.3 it is also the case that: $D\left(\text{Prd}^{q,\varepsilon} \bullet \left[\text{Tun}_{\text{D}(\text{Pwr}_{n-1}^{q,\varepsilon})} \boxminus \text{Pwr}_{n-1}^{q,\varepsilon}\right] \bullet \text{Cpy}\right) = D\left(\text{Prd}^{q,\varepsilon} \bullet \left[\text{Tun}_{\text{D}(\text{Pwr}_{n-1}^{q,\varepsilon})} \boxminus \text{Pwr}_{n-1}^{q,\varepsilon}\right]\right)$. Note also that by Lemma we have that $D\left(\text{Tun}_{\text{D}(\text{Pwr}_{n-1}^{q,\varepsilon})} \boxminus \text{Pwr}_{n-1}^{q,\varepsilon}\right) =$

$D(\text{Pwr}_{n-1}^{q,\varepsilon})$. This with Lemma 5.2.5 then yields for $n \in \mathbb{N}$ that:

$$\begin{aligned}
D(\text{Pwr}_n^{q,\varepsilon}) &= D\left(\text{Prd} \bullet \left[\text{Tun}_{\mathcal{D}(\text{Pwr}_{n-1}^{q,\varepsilon})} \boxminus \text{Pwr}_{n-1}^{q,\varepsilon}\right] \bullet \text{Cpy}_{2,1}\right) \\
&= D\left(\text{Prd} \bullet \left[\text{Tun}_{\mathcal{D}(\text{Pwr}_{n-1}^{q,\varepsilon})} \boxminus \text{Pwr}_{n-1}^{q,\varepsilon}\right]\right) \\
&= D(\text{Prd}) + D\left(\text{Tun}_{\mathcal{D}(\text{Pwr}_{n-1}^{q,\varepsilon})}\right) - 1 \\
&\leq \frac{q}{q-2} \left[\log_2(\varepsilon^{-1}) + q\right] + D\left(\text{Tun}_{\mathcal{D}(\text{Pwr}_{n-1}^{q,\varepsilon})}\right) - 1 \\
&= \frac{q}{q-2} \left[\log_2(\varepsilon^{-1}) + q\right] + D(\text{Pwr}_{n-1}^{q,\varepsilon}) - 1
\end{aligned} \tag{6.2.23}$$

And hence for all $n \in \mathbb{N}$ it is the case that:

$$D(\text{Pwr}_n^{q,\varepsilon}) - D(\text{Pwr}_{n-1}^{q,\varepsilon}) \leq \frac{q}{q-2} \left[\log_2(\varepsilon^{-1}) + q\right] - 1 \tag{6.2.24}$$

This, in turn, indicates that:

$$\begin{aligned}
D(\text{Pwr}_n^{q,\varepsilon}) &\leq n \left[\frac{q}{q-2} \left[\log_2(\varepsilon^{-1}) + q\right] - 1 \right] + 1 \\
&\leq n \left[\frac{q}{q-2} \left[\log_2(\varepsilon^{-1}) + q\right] - 1 \right] + 1
\end{aligned} \tag{6.2.25}$$

This proves Item (ii).

Note now that $W_1(\text{Pwr}_0^{q,\varepsilon}) = W_1(\text{Aff}_{0,1}) = 1$. Further Lemma 5.2.5, Remark 5.5.2, tells us that for all $i, k \in \mathbb{N}$ it is the case that $W_i(\text{Tun}_k) \leq 2$. Observe that since $\text{Cpy}_{2,1}$, $\text{Pwr}_0^{q,\varepsilon}$, and $\text{Tun}_{\mathcal{D}(\text{Pwr}_0^{q,\varepsilon})}$ are all affine neural networks, Lemma 5.5.5, Corollary 5.5.5.1, and Lemma 6.1.10 tells us that:

$$\begin{aligned}
W_1(\text{Pwr}_1^{q,\varepsilon}) &= W_1\left(\text{Prd}^{q,\varepsilon} \bullet \left[\text{Tun}_{\mathcal{D}(\text{Pwr}_0^{q,\varepsilon})} \boxminus \text{Pwr}_0^{q,\varepsilon}\right] \bullet \text{Cpy}_{2,1}\right) \\
&= W_1(\text{Prd}^{q,\varepsilon}) = 24
\end{aligned} \tag{6.2.26}$$

And that:

$$\begin{aligned}
W_1(\text{Pwr}_2^{q,\varepsilon}) &= W_1\left(\text{Prd}^{q,\varepsilon} \bullet \left[\text{Tun}_{\text{D}(\text{Pwr}_1^{q,\varepsilon})} \boxminus \text{Pwr}_1^{q,\varepsilon}\right] \bullet \text{Cpy}_{2,1}\right) \\
&= W_1\left(\left[\text{Tun}_{\text{D}(\text{Pwr}_1^{q,\varepsilon})} \boxminus \text{Pwr}_1^{q,\varepsilon}\right]\right) \\
&= 24 + 2 = 26
\end{aligned}$$

This completes the base case. For the inductive case, assume that for all i up to and including

$$k \in \mathbb{N} \text{ it is the case that } W_1(\text{Pwr}_i^{q,\varepsilon}) \leq \begin{cases} 1 & : i = 0 \\ 24 + 2(i - 1) & : i \in \mathbb{N} \end{cases}. \text{ For the case of } k + 1, \text{ we get that:}$$

$$\begin{aligned}
W_1(\text{Pwr}_{k+1}^{q,\varepsilon}) &= W_1\left(\text{Prd}^{q,\varepsilon} \bullet \left[\text{Tun}_{\text{D}(\text{Pwr}_k^{q,\varepsilon})} \boxminus \text{Pwr}_k^{q,\varepsilon}\right] \bullet \text{Cpy}_{2,1}\right) \\
&= W_1\left(\left[\text{Tun}_{\text{D}(\text{Pwr}_k^{q,\varepsilon})} \boxminus \text{Pwr}_k^{q,\varepsilon}\right]\right) \\
&= W_1\left(\text{Tun}_{\text{D}(\text{Pwr}_k^{q,\varepsilon})}\right) + W_1(\text{Pwr}_k^{q,\varepsilon}) \\
&\leq \begin{cases} 2 & : k = 0 \\ 24 + 2k & : k \in \mathbb{N} \end{cases} \tag{6.2.27}
\end{aligned}$$

This establishes Item (iii).

For Item (iv), we will prove this in cases.

Case 1: $\text{Pwr}_0^{q,\varepsilon}$:

Note that by Lemma 5.5.2 we have that:

$$P(\text{Pwr}_0^{q,\varepsilon}) = P(\text{Aff}_{0,1}) = 2 \tag{6.2.28}$$

This completes Case 1.

Case 2: $\text{Pwr}_n^{q,\varepsilon}$ where $n \in \mathbb{N}$:

Note that Lemma 5.3.5, Lemma 6.2.13, Corollary 5.3.5.1, Lemma 5.3.6, and Corollary 5.3.6.1, tells

us it is the case that:

$$\begin{aligned} \mathbb{P}\left(\text{Pwr}_{n-1}^{q,\varepsilon} \boxplus \text{Tun}_{\mathbb{D}}(\text{Pwr}_{n-1}^{q,\varepsilon})\right) &\leq \mathbb{P}\left(\text{Pwr}_{n-1}^{q,\varepsilon} \boxplus \text{Pwr}_{n-1}^{q,\varepsilon}\right) \\ &\leq 4 \mathbb{P}\left(\text{Pwr}_{n-1}^{q,\varepsilon}\right) \end{aligned} \quad (6.2.29)$$

Then Lemma 5.2.5 and Corollary 5.5.5.1 tells us that:

$$\begin{aligned} &\mathbb{P}\left(\left[\text{Pwr}_{n-1}^{q,\varepsilon} \boxplus \text{Tun}_{\mathbb{D}}(\text{Pwr}_{n-1}^{q,\varepsilon})\right] \bullet \text{Cpy}_{2,1}\right) \\ &= \mathbb{P}\left(\left[\text{Pwr}_{n-1}^{q,\varepsilon} \boxplus \text{Tun}_{\mathbb{D}}(\text{Pwr}_{n-1}^{q,\varepsilon})\right]\right) \\ &\leq 4 \mathbb{P}\left(\text{Pwr}_{n-1}^{q,\varepsilon}\right) \end{aligned} \quad (6.2.30)$$

Note next that by definition for all $q \in (2, \infty)$, and $\varepsilon \in (0, \infty)$ it is case that $W_{\mathbb{H}(\text{Pwr}_0^{q,\varepsilon})} \text{Pwr}_0^{q,\varepsilon} = W_{\mathbb{H}(\text{Aff}_{0,1})} = 1$. Now, by Lemma 6.1.10, and by construction of $\text{Pwr}_i^{q,\varepsilon}$ we may say that for $i \in \mathbb{N}$ it is the case that:

$$W_{\mathbb{H}(\text{Pwr}_i^{q,\varepsilon})} = W_{\mathbb{H}(\text{Prd}^{q,\varepsilon})} = 24 \quad (6.2.31)$$

Note also that by Lemma 6.2.3 it is the case that:

$$W_{\mathbb{H}\left(\text{Tun}_{\mathbb{D}}(\text{Pwr}_{i-1}^{q,\varepsilon})\right)}\left(\text{Tun}_{\mathbb{D}}(\text{Pwr}_{i-1}^{q,\varepsilon})\right) = 2 \quad (6.2.32)$$

Furthermore, note that for $n \in [2, \infty) \cap \mathbb{N}$ Lemma 6.1.10 tells us that:

$$W_{\mathbb{H}\left(\left[\text{Pwr}_{n-1}^{q,\varepsilon} \boxplus \text{Tun}_{\mathbb{D}}(\text{Pwr}_{n-1}^{q,\varepsilon})\right]\right)}\left(\left[\text{Pwr}_{n-1}^{q,\varepsilon} \boxplus \text{Tun}_{\mathbb{D}}(\text{Pwr}_{n-1}^{q,\varepsilon})\right]\right) = 24 + 2 = 26 \quad (6.2.33)$$

Finally Lemma 5.2.5, (6.2.30), and Corollary 5.3.5.1, also tells us that:

$$\begin{aligned}
& \mathbb{P}(\text{Pwr}_n^{q,\varepsilon}) && (6.2.34) \\
&= \mathbb{P}\left(\text{Prd}^{q,\varepsilon} \bullet \left[\text{Pwr}_{n-1}^{q,\varepsilon} \boxminus \text{Tun}_{\mathbb{D}(\text{Pwr}_{n-1}^{q,\varepsilon})}\right] \bullet \text{Cpy}_{2,1}\right) \\
&= \mathbb{P}\left(\text{Prd}^{q,\varepsilon} \bullet \left[\text{Pwr}_{n-1}^{q,\varepsilon} \boxminus \text{Tun}_{\mathbb{D}(\text{Pwr}_{n-1}^{q,\varepsilon})}\right]\right) \\
&\leq \mathbb{P}(\text{Prd}^{q,\varepsilon}) + 4\mathbb{P}(\text{Pwr}_{n-1}^{q,\varepsilon}) + \\
&+ W_1(\text{Prd}^{q,\varepsilon}) \cdot W_H\left(\left[\text{Pwr}_{n-1}^{q,\varepsilon} \boxminus \text{Tun}_{\mathbb{D}(\text{Pwr}_{n-1}^{q,\varepsilon})}\right]\right) \left(\left[\text{Pwr}_{n-1}^{q,\varepsilon} \boxminus \text{Tun}_{\mathbb{D}(\text{Pwr}_{n-1}^{q,\varepsilon})}\right]\right) \\
&= \mathbb{P}(\text{Prd}^{q,\varepsilon}) + 4\mathbb{P}(\text{Pwr}_{n-1}^{q,\varepsilon}) + 624 \\
&= 4^{n+1}\mathbb{P}(\text{Pwr}_0^{q,\varepsilon}) + \left(\frac{4^{n+1}-1}{3}\right)(\mathbb{P}(\text{Prd}^{q,\varepsilon}) + 624) \\
&= 4^{n+\frac{3}{2}} + \left(\frac{4^{n+1}-1}{3}\right) \left(\frac{360q}{q-2} [\log_2(\varepsilon^{-1}) + q + 1] + 372\right) && (6.2.35)
\end{aligned}$$

Next note that $(\mathfrak{J}_\tau(\text{Pwr}_{0,1}))(x)$ is exactly 1, which implies that for all $x \in \mathbb{R}$ we have that $|x^0 - (\mathfrak{J}_\tau(\text{Pwr}_{0,1}))(x)| = 0$. Note also that the instantiations of Tun_n and $\text{Cpy}_{2,1}$ are exact. Note next that since Tun_n and $\text{Cpy}_{2,1}$ are exact, the only sources of error for $\text{Pwr}_n^{q,\varepsilon}$ are n compounding applications of $\text{Prd}^{q,\varepsilon}$.

Note also that by definition, it is the case that:

$$\mathfrak{J}_\tau(\text{Pwr}_n^{q,\varepsilon}) = \mathfrak{J}_\tau \left[\underbrace{\text{Prd}^{q,\varepsilon}(\mathfrak{J}_\tau[\text{Prd}^{q,\varepsilon}(\dots \mathfrak{J}_\tau[\text{Prd}^{q,\varepsilon}(1,x)], \dots x)], x)}_{n\text{-copies}} \right] \quad (6.2.36)$$

Lemma 6.1.10 tells us that:

$$|x - \mathfrak{J}_\tau(\text{Prd}^{q,\varepsilon}(1,x))| \leq \varepsilon \max\{1, |x|^q\} \leq \varepsilon + |x|^q \quad (6.2.37)$$

The triangle inequality, Lemma 6.2.10, Lemma 6.1.10, and Corollary 6.1.10.1 then tells us that:

$$\begin{aligned}
& |x^2 - \mathfrak{J}_\tau(\text{Pwr}_2^{q,\varepsilon})(x)| \\
&= |x \cdot x - \mathfrak{J}_\tau(\text{Prd}^{q,\varepsilon}(\mathfrak{J}_\tau(\text{Prd}^{q,\varepsilon}(1, x)), x))| \\
&\leq |x \cdot x - x \cdot \mathfrak{J}_\tau(\text{Prd}^{q,\varepsilon}(1, x))| + |x \cdot \mathfrak{J}_\tau(\text{Prd}^{q,\varepsilon}(1, x)) - \mathfrak{J}_\tau(\text{Prd}^{q,\varepsilon}(\mathfrak{J}_\tau(\text{Prd}^{q,\varepsilon}(1, x)), x))| \\
&= |x(x - \mathfrak{J}_\tau(\text{Prd}^{q,\varepsilon}(1, x)))| + \varepsilon + \varepsilon|x|^q + \varepsilon|\mathfrak{J}_\tau(\text{Prd}^{q,\varepsilon}(1, x))|^q \\
&\leq |x\varepsilon + x\varepsilon|x|^q| + \varepsilon + \varepsilon|x|^q + \varepsilon|\varepsilon + 2 + x^2|^q \\
&= |x\varepsilon + x\varepsilon|x|^q| + \varepsilon + \varepsilon|x|^q + \varepsilon\mathfrak{p}_1^q
\end{aligned} \tag{6.2.38}$$

Note that this takes care of our base case. Assume now that for all integers up to and including n , it is the case that:

$$\begin{aligned}
|x^n - \mathfrak{J}_\tau(\text{Pwr}_n^{q,\varepsilon})(x)| &\leq |x \cdot x^{n-1} - x \cdot \mathfrak{J}_\tau(\text{Pwr}_{n-1}^{q,\varepsilon})(x)| + |x \cdot \mathfrak{J}_\tau(\text{Pwr}_{n-1}^{q,\varepsilon})(x) - \mathfrak{J}_\tau(\text{Pwr}_n^{q,\varepsilon})(x)| \\
&\leq |x(x^{n-1} - \mathfrak{J}_\tau(\text{Pwr}_{n-1}^{q,\varepsilon})(x))| + \varepsilon + \varepsilon|x|^q + \varepsilon|\mathfrak{J}_\tau(\text{Pwr}_{n-1}^{q,\varepsilon})(x)|^q \\
&\leq |x(x^{n-1} - \mathfrak{J}_\tau(\text{Pwr}_{n-1}^{q,\varepsilon})(x))| + \varepsilon + \varepsilon|x|^q + \varepsilon\mathfrak{p}_{n-1}^q
\end{aligned} \tag{6.2.39}$$

For the inductive case, we see that:

$$\begin{aligned}
|x^{n+1} - \mathfrak{J}_\tau(\text{Pwr}_{n+1}^{q,\varepsilon})(x)| &\leq |x^{n+1} - x \cdot \mathfrak{J}_\tau(\text{Pwr}_n^{q,\varepsilon})(x)| + |x \cdot \mathfrak{J}_\tau(\text{Pwr}_n^{q,\varepsilon})(x) - \mathfrak{J}_\tau(\text{Pwr}_{n+1}^{q,\varepsilon})(x)| \\
&\leq |x(x^n - \mathfrak{J}_\tau(\text{Pwr}_n^{q,\varepsilon})(x))| + \varepsilon + \varepsilon|x|^q + \varepsilon|\mathfrak{J}_\tau(\text{Pwr}_n^{q,\varepsilon})(x)|^q \\
&\leq |x(x^n - \mathfrak{J}_\tau(\text{Pwr}_n^{q,\varepsilon})(x))| + \varepsilon + \varepsilon|x|^q + \varepsilon\mathfrak{p}_n^q
\end{aligned} \tag{6.2.40}$$

Note that since $\mathfrak{p}_n \in \mathcal{O}(\varepsilon^{2(n-1)})$ for $n \in \mathbb{N} \cap [2, \infty)$, it is the case for all $x \in \mathbb{R}$ then that $|x^n - \mathfrak{J}_\tau(\text{Pwr}_n^{q,\varepsilon})(x)| \in \mathcal{O}(\varepsilon^{2q(n-1)})$ for $n \geq 2$.

Finally note that $W_{\text{H}(\text{Pwr}_0^{q,\varepsilon})}(\text{Pwr}_0^{q,\varepsilon}) = 1$ from observation. For $n \in \mathbb{N}$, note that the second to last layer is the second to last layer of the $\text{Prd}^{q,\varepsilon}$ network. Thus Lemma 6.1.10 tells us that:

$$W_{\text{H}(\text{Pwr}_m^{q,\varepsilon})}(\text{Pwr}_n^{q,\varepsilon}) = \begin{cases} 1 & n = 0 \\ 24 & n \in \mathbb{N} \end{cases} \tag{6.2.41}$$

This completes the proof of the lemma. \square

Remark 6.2.15. Note each power network $\text{Pwr}_n^{q,\varepsilon}$ is at least as big as the previous power network $\text{Pwr}_{n-1}^{q,\varepsilon}$, one differs from the other by one $\text{Prd}^{q,ve}$ network.

6.2.3 $\text{Pnm}_{n,C}^{q,\varepsilon}$ and Neural Network Polynomials.

Definition 6.2.16 (Neural Network Polynomials). Let $\delta, \varepsilon \in (0, \infty)$, $q \in (2, \infty)$ and $\delta = \varepsilon (2^{q-1} + 1)^{-1}$. For fixed q, ε , fixed $n \in \mathbb{N}_0$, and for $C = \{c_0, c_1, \dots, c_n\} \in \mathbb{R}^{n+1}$ (the set of coefficients), we will define the following objects as neural network polynomials:

$$\text{Pnm}_{n,C}^{q,\varepsilon} := \bigoplus_{i=0}^n \left(c_i \triangleright \left[\text{Tun}_{\max_i \{D(\text{Pwr}_i^{q,\varepsilon})\} + 1 - D(\text{Pwr}_i^{q,\varepsilon})} \bullet \text{Pwr}_i^{q,\varepsilon} \right] \right) \quad (6.2.42)$$

Remark 6.2.17. Diagrammatically, these can be represented as

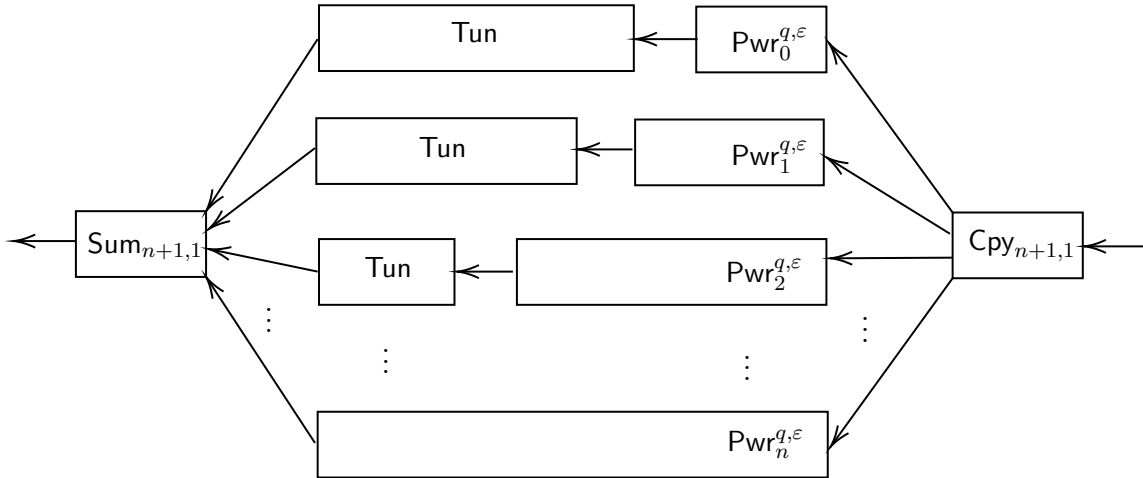

Figure 6.6: Neural network diagram for an elementary neural network polynomial.

Lemma 6.2.18 (R—,2023). Let $\delta, \varepsilon \in (0, \infty)$, $q \in (2, \infty)$ and $\delta = \varepsilon (2^{q-1} + 1)^{-1}$. It is then the case for all $n \in \mathbb{N}_0$ and $x \in \mathbb{R}$ that:

$$(i) \mathfrak{J}_\tau \left(\text{Pnm}_{n,C}^{q,\varepsilon} \right) \in C(\mathbb{R}, \mathbb{R})$$

$$(ii) D \left(\text{Pnm}_{n,C}^{q,\varepsilon} \right) \leq \begin{cases} 1 & : n = 0 \\ n \left[\frac{q}{q-2} \left[\log_2(\varepsilon^{-1}) + q \right] - 1 \right] + 1 & : n \in \mathbb{N} \end{cases}$$

$$(iii) \ P \left(\text{Pnm}_{n,C}^{q,\varepsilon} \right) \leq \begin{cases} 2 & : n = 0 \\ (n+1) \left[4^{n+\frac{3}{2}} + \left(\frac{4^{n+1}-1}{3} \right) \left(\frac{360q}{q-2} \left[\log_2(\varepsilon^{-1}) + q + 1 \right] + 372 \right) \right] & : n \in \mathbb{N} \end{cases}$$

$$(iv) \ \left| \sum_{i=0}^n c_i x^i - \mathfrak{J}_\tau \left(\text{Pnm}_{n,C}^{q,\varepsilon} \right) (x) \right| \leq \sum_{i=1}^n c_i \left(|x(x^{i-1} - \mathfrak{J}_\tau(\text{Pwr}_{i-1}^{q,\varepsilon})(x))| + \varepsilon + |x|^q + \mathfrak{p}_{i-1}^q \right)$$

Where \mathfrak{p}_i are the set of functions defined for $i \in \mathbb{N}$ as such:

$$\begin{aligned} \mathfrak{p}_1 &= \varepsilon + 1 + |x|^2 \\ \mathfrak{p}_i &= \varepsilon + (\mathfrak{p}_{i-1})^2 + |x|^2 \end{aligned} \tag{6.2.43}$$

Whence it is the case that:

$$\left| \sum_{i=0}^n c_i x^i - \mathfrak{J}_\tau \left(\text{Pnm}_{n,C}^{q,\varepsilon} \right) (x) \right| \in \mathcal{O} \left(\varepsilon^{2q(n-1)} \right) \tag{6.2.44}$$

$$(v) \ W_1 \left(\text{Pnm}_{n,C}^{q,\varepsilon} \right) = 2 + 23n + n^2$$

$$(vi) \ W_{\text{H}(\text{Pnm}_{n,C}^{q,\varepsilon})} \left(\text{Pnm}_{n,C}^{q,\varepsilon} \right) \leq \begin{cases} 1 & : n = 0 \\ 24 + 2n & : n \in \mathbb{N} \end{cases}$$

Proof. Note that by Lemma 5.7.5, Lemma 6.2.14, and Lemma 5.2.5 for all $n \in \mathbb{N}_0$ it is the case that:

$$\begin{aligned} \mathfrak{J}_\tau \left(\text{Pnm}_{n,C}^{q,\varepsilon} \right) &= \mathfrak{J}_\tau \left(\bigoplus_{i=0}^n \left[c_i \triangleright \left[\text{Tun}_{\max_i \{D(\text{Pwr}_i^{q,\varepsilon})\} + 1 - D(\text{Pwr}_i^{q,\varepsilon})} \bullet \text{Pwr}_i^{q,\varepsilon} \right] \right] \right) \\ &= \sum_{i=1}^n c_i \mathfrak{J}_\tau \left(\text{Tun}_{\max_i \{D(\text{Pwr}_i^{q,\varepsilon})\} + 1 - D(\text{Pwr}_i^{q,\varepsilon})} \bullet \text{Pwr}_i^{q,\varepsilon} \right) \\ &= \sum_{i=1}^n c_i \mathfrak{J}_\tau \left(\text{Pwr}_i^{q,\varepsilon} \right) \end{aligned}$$

Since Lemma 6.2.14 tells us that $(\mathfrak{J}_\tau(\text{Pwr}_n^{q,\varepsilon}))(x) \in C(\mathbb{R}, \mathbb{R})$, for all $n \in \mathbb{N}_0$ and since the finite sum of continuous functions is continuous, this proves Item (i).

Note that $\text{Pnm}_n^{q,\varepsilon}$ is only as deep as the deepest of the $\text{Pwr}_i^{q,\varepsilon}$ networks, which from the definition is

$\text{Pwr}_n^{q,\varepsilon}$, which in turn also has the largest bound. Therefore, by Lemma 5.2.5, Lemma 5.5.5, Lemma 5.6.10, and Lemma 6.2.14, we have that:

$$\begin{aligned} D\left(\text{Pnm}_{n,C}^{q,\varepsilon}\right) &\leq D\left(\text{Pwr}_n^{q,\varepsilon}\right) \\ &\leq \begin{cases} 1 & : n = 0 \\ n \left[\frac{q}{q-2} [\log_2(\varepsilon^{-1}) + q] - 1 \right] + 1 & : n \in \mathbb{N} \end{cases} \end{aligned}$$

This proves Item (ii).

Note next that for the case of $n = 0$, we have that:

$$\text{Pnm}_n^{q,\varepsilon} = c_i \triangleright \text{Pwr}_0^{q,\varepsilon} \tag{6.2.45}$$

This then yields us 2 parameters.

Note that each neural network summand in $\text{Pnm}_n^{q,\varepsilon}$ consists of a combination of Tun_k and Pwr_k for some $k \in \mathbb{N}$. Each Pwr_k has at least as many parameters as a tunneling neural network of that depth, as Lemma 6.2.13 tells us. This, finally, with Lemma 5.5.5, Corollary 5.5.5.1, and Lemma 6.2.14 then implies that:

$$\begin{aligned} P\left(\text{Pnm}_{n,C}^{q,\varepsilon}\right) &= P\left(\bigoplus_{i=0}^n \left[c_i \triangleright \left[\text{Tun}_{\max_i \{D(\text{Pwr}_i^{q,\varepsilon})\} + 1 - D(\text{Pwr}_i^{q,\varepsilon})} \bullet \text{Pwr}_i^{q,\varepsilon} \right] \right]\right) \\ &\leq (n+1) \cdot P\left(c_i \triangleright [\text{Tun}_1 \bullet \text{Pwr}_n^{q,\varepsilon}]\right) \\ &\leq (n+1) \cdot P\left(\text{Pwr}_n^{q,\varepsilon}\right) \\ &\leq \begin{cases} 2 & : n = 0 \\ (n+1) \left[4^{n+\frac{3}{2}} + \left(\frac{4^{n+1}-1}{3}\right) \left(\frac{360q}{q-2} [\log_2(\varepsilon^{-1}) + q + 1] + 372\right) \right] & : n \in \mathbb{N} \end{cases} \end{aligned}$$

This proves Item (iii).

Finally, note that for all $i \in \mathbb{N}$, Lemma 6.2.14, and the triangle inequality then tells us that it is

the case for all $i \in \mathbb{N}$ that:

$$\left| x^i - \mathfrak{J}_\tau (\text{Pwr}_i^{q,\varepsilon}) (x) \right| \leq \left| x^i - x \cdot \mathfrak{J}_\tau (\text{Pwr}_{i-1}^{q,\varepsilon}) (x) \right| + \left| x \cdot \mathfrak{J}_\tau (\text{Pwr}_{i-1}^{q,\varepsilon}) (x) - \mathfrak{J}_\tau (\text{Pwr}_i^{q,\varepsilon}) (x) \right| \quad (6.2.46)$$

This, Lemma 6.2.28, and the fact that instantiation of the tunneling neural network leads to the identity function (Lemma 6.2.3 and Lemma 5.2.5), together with Lemma 5.7.8, and the absolute homogeneity condition of norms, then tells us that for all $x \in \mathbb{R}$, and $c_0, c_1, \dots, c_n \in \mathbb{R}$ it is the case that:

$$\begin{aligned} & \left| \sum_{i=0}^n c_i x^i - \mathfrak{J}_\tau (\text{Pnm}_{n,C}^{q,\varepsilon}) (x) \right| \\ &= \left| \sum_{i=0}^n c_i x^i - \mathfrak{J}_\tau \left[\bigoplus_{i=0}^n \left[c_i \triangleright \text{Tun}_{\max_i \{D(\text{Pwr}_i^{q,\varepsilon})\} + 1 - D(\text{Pwr}_i^{q,\varepsilon})} \bullet \text{Pwr}_i^{q,\varepsilon} \right] \right] (x) \right| \\ &= \left| \sum_{i=1}^n c_i x^i - \sum_{i=0}^n c_i \left(\mathfrak{J}_\tau \left[\text{Tun}_{\max_i \{D(\text{Pwr}_i^{q,\varepsilon})\} + 1 - D(\text{Pwr}_i^{q,\varepsilon})} \bullet \text{Pwr}_i^{q,\varepsilon} \right] (x) \right) \right| \\ &\leq \sum_{i=1}^n |c_i| \cdot \left| x^i - \mathfrak{J}_\tau \left[\text{Tun}_{\max_i \{D(\text{Pwr}_i^{q,\varepsilon})\} + 1 - D(\text{Pwr}_i^{q,\varepsilon})} \bullet \text{Pwr}_i^{q,\varepsilon} \right] (x) \right| \\ &\leq \sum_{i=1}^n |c_i| \cdot \left(\left| x (x^{i-1} - \mathfrak{J}_\tau (\text{Pwr}_{i-1}^{q,\varepsilon}) (x)) \right| + \varepsilon + |x|^q + \mathfrak{p}_{i-1}^q \right) \end{aligned}$$

Note however that since for all $x \in \mathbb{R}$ and $i \in \mathbb{N} \cap [2, \infty)$, Lemma 6.1.10 tells us that $\left| x^i - \mathfrak{J}_\tau (\text{Pwr}_i^{q,\varepsilon}) (x) \right| \in \mathcal{O}(\varepsilon^{2q(i-1)})$, this, and the fact that $f + g \in \mathcal{O}(x^a)$ if $f \in \mathcal{O}(x^a)$, $g \in \mathcal{O}(x^b)$, and $a \geq b$, then implies that:

$$\sum_{i=1}^n |c_i| \cdot \left(\left| x (x^{i-1} - \mathfrak{J}_\tau (\text{Pwr}_{i-1}^{q,\varepsilon}) (x)) \right| + \varepsilon + |x|^q + \mathfrak{p}_{i-1}^q \right) \in \mathcal{O}(\varepsilon^{2q(n-1)}) \quad (6.2.47)$$

This proves Item (iv).

Note next in our construction $\text{Aff}_{0,1}$ will require tunneling whenever $i \in \mathbb{N}$ in $\text{Pwr}_i^{q,\varepsilon}$. Lemma 5.5.5

and Corollary 5.5.5.1 then tell us that:

$$\begin{aligned}
W_1(\text{Pnm}_n^{q,\varepsilon}) &= W_1\left(\bigoplus_{i=0}^n \left[c_i \triangleright \left[\text{Tun}_{\max_i\{D(\text{Pwr}_i^{q,\varepsilon})\}+1-D(\text{Pwr}_i^{q,\varepsilon})} \bullet \text{Pwr}_i^{q,\varepsilon} \right] \right] \right) \\
&= W_1\left(\bigoplus_{i=0}^n \text{Pwr}_i^{q,\varepsilon}\right) \\
&\leq \sum_{i=0}^n W_1(\text{Pwr}_i^{q,\varepsilon}) = 2 + \frac{n}{2}(24 + 24 + 2(n-1)) = 2 + 23n + n^2
\end{aligned} \tag{6.2.48}$$

This proves Item (v).

Finally note that from the definition of the $\text{Pnm}_{n,C}^{q,\varepsilon}$, it is evident that $W_{\text{H}(\text{Pwr}_{0,C}^{q,\varepsilon})}(\text{Pwr}_{0,C}^{q,\varepsilon}) = 1$ since $\text{Pwr}_{0,C}^{q,\varepsilon} = \text{Aff}_{0,1}$. Other than this network, for all $i \in \mathbb{N}$, $\text{Pwr}_{i,C}^{q,\varepsilon}$ end in the $\text{Prd}^{q,\varepsilon}$ network, and the deepest of the $\text{Pwr}_i^{q,\varepsilon}$ networks is $\text{Pwr}_n^{q,\varepsilon}$ inside $\text{Pnm}_{n,C}^{q,\varepsilon}$. All other $\text{Pwr}_i^{q,\varepsilon}$ must end in tunnels. Whence in the second to last layer, Lemma 6.1.10 tells us that:

$$W_{\text{H}(\text{Pnm}_{n,C}^{q,\varepsilon})} \leq \begin{cases} 1 & : n = 0 \\ 24 + 2n & : n \in \mathbb{N} \end{cases} \tag{6.2.49}$$

This completes the proof of the Lemma. □

6.2.4 $\text{Xpn}_n^{q,\varepsilon}$, $\text{Csn}_n^{q,\varepsilon}$, $\text{Sne}_n^{q,\varepsilon}$, and Neural Network Approximations of e^x , $\cos(x)$, and $\sin(x)$.

Once we have neural network polynomials, we may take the next leap to transcendental functions. Here, we will explore neural network approximations for three common transcendental functions: e^x , $\cos(x)$, and $\sin(x)$.

Lemma 6.2.19. *Let $\nu_1, \nu_2 \in \text{NN}$, $f, g \in C(\mathbb{R}, \mathbb{R})$, and $\varepsilon_1, \varepsilon_2 \in (0, \infty)$ such that for all $x \in \mathbb{R}$ it holds that $|f(x) - \mathfrak{J}_\tau(\nu_1)| \leq \varepsilon_1$ and $|g(x) - \mathfrak{J}_\tau(\nu_2)| \leq \varepsilon_2$. It is then the case for all $x \in \mathbb{R}$ that:*

$$|[f + g](x) - \mathfrak{J}_\tau([\nu_1 \oplus \nu_2])(x)| \leq \varepsilon_1 + \varepsilon_2 \tag{6.2.50}$$

Proof. Note that the triangle inequality tells us:

$$\begin{aligned} |[f + g](x) - \mathfrak{J}_\tau[\nu_1 \oplus \nu_2](x)| &= |f(x) + g(x) - \mathfrak{J}_\tau(\nu_1)(x) - \mathfrak{J}_\tau(\nu_2)(x)| \\ &\leq |f(x) - \mathfrak{J}_\tau(\nu_1)(x)| + |g(x) - \mathfrak{J}_\tau(\nu_2)(x)| \\ &\leq \varepsilon_1 + \varepsilon_2 \end{aligned}$$

□

Lemma 6.2.20. *Let $n \in \mathbb{N}$. Let $\nu_1, \nu_2, \dots, \nu_n \in \mathbb{NN}$, $\varepsilon_1, \varepsilon_2, \dots, \varepsilon_n \in (0, \infty)$ and $f_1, f_2, \dots, f_n \in C(\mathbb{R}, \mathbb{R})$ such that for all $i \in \{1, 2, \dots, n\}$, and for all $x \in \mathbb{R}$, it is the case that, $|f_i(x) - \mathfrak{J}_\tau(\nu_i)(x)| \leq \varepsilon_i$. It is then the case for all $x \in \mathbb{R}$, that:*

$$\left| \sum_{i=1}^n f_i(x) - \bigoplus_{i=1}^n (\mathfrak{J}_\tau(\nu_i))(x) \right| \leq \sum_{i=1}^n \varepsilon_i \quad (6.2.51)$$

Proof. This is a consequence of a finite number of applications of (6.2.50). □

Definition 6.2.21 (R—2023, $\mathsf{Xpn}_n^{q,\varepsilon}$ and the Neural Network Taylor Approximations for e^x around $x = 0$). *Let $\delta, \varepsilon \in (0, \infty)$, $q \in (2, \infty)$ and $\delta = \varepsilon(2^{q-1} + 1)^{-1}$, and let $\mathsf{Pwr}_n^{q,\varepsilon}$ be as in Lemma 6.2.14. We define, for all $n \in \mathbb{N}_0$, the family of neural networks $\mathsf{Xpn}_n^{q,\varepsilon}$ as:*

$$\mathsf{Xpn}_n^{q,\varepsilon} := \bigoplus_{i=0}^n \left[\frac{1}{i!} \triangleright \left[\mathsf{Tun}_{\max_i \{D(\mathsf{Pwr}_i^{q,\varepsilon})\} + 1 - D(\mathsf{Pwr}_i^{q,\varepsilon})} \bullet \mathsf{Pwr}_i^{q,\varepsilon} \right] \right] \quad (6.2.52)$$

Lemma 6.2.22 (R—,2023). *Let $\delta, \varepsilon \in (0, \infty)$, $q \in (2, \infty)$ and $\delta = \varepsilon(2^{q-1} + 1)^{-1}$. It is then the case for all $n \in \mathbb{N}_0$ and $x \in \mathbb{R}$ that:*

- (i) $\mathfrak{J}_\tau(\mathsf{Xpn}_n^{q,\varepsilon})(x) \in C(\mathbb{R}, \mathbb{R})$
- (ii) $D(\mathsf{Xpn}_n^{q,\varepsilon}) \leq \begin{cases} 1 & : n = 0 \\ n \left[\frac{q}{q-2} [\log_2(\varepsilon^{-1}) + q] - 1 \right] + 1 & : n \in \mathbb{N} \end{cases}$
- (iii) $P(\mathsf{Xpn}_n^{q,\varepsilon}) \leq \begin{cases} 2 & : n = 0 \\ (n+1) \left[4^{n+\frac{3}{2}} + \left(\frac{4^{n+1}-1}{3} \right) \left(\frac{360q}{q-2} [\log_2(\varepsilon^{-1}) + q + 1] + 372 \right) \right] & : n \in \mathbb{N} \end{cases}$

(iv)

$$\left| \sum_{i=0}^n \left[\frac{x^i}{i!} \right] - \mathfrak{J}_\tau(\mathbf{Xpn}_n^{q,\varepsilon})(x) \right| \leq \sum_{i=1}^n \frac{1}{i!} (|x(x^{i-1} - \mathfrak{J}_\tau(\mathbf{Pwr}_{i-1}^{q,\varepsilon})(x))| + \varepsilon + |x|^q + \mathbf{p}_{i-1}^q)$$

Where \mathbf{p}_i are the set of functions defined for $i \in \mathbb{N}$ as such:

$$\begin{aligned} \mathbf{p}_1 &= \varepsilon + 1 + |x|^2 \\ \mathbf{p}_i &= \varepsilon + (\mathbf{p}_{i-1})^2 + |x|^2 \end{aligned} \quad (6.2.53)$$

Whence it is the case that:

$$\left| \sum_{i=0}^n \left[\frac{x^i}{i!} \right] - \mathfrak{J}_\tau(\mathbf{Xpn}_n^{q,\varepsilon})(x) \right| \in \mathcal{O}(\varepsilon^{2q(n-1)}) \quad (6.2.54)$$

$$(v) \quad \mathbf{W}_1(\mathbf{Xpn}_n^{q,\varepsilon}) = 2 + 23n + n^2$$

$$(vi) \quad \mathbf{W}_{\mathbf{H}(\mathbf{Xpn}_{q,\varepsilon}^n)}(\mathbf{Xpn}_n^{q,\varepsilon}) \leq 24 + 2n$$

Proof. This follows straightforwardly from Lemma 6.2.18 with $c_i \curvearrowright \frac{1}{i!}$ for all $n \in \mathbb{N}$ and $i \in \{0, 1, \dots, n\}$. In particular, Item (iv) benefits from the fact that for all $i \in \mathbb{N}_0$, it is the case that $\frac{1}{i!} \geq 0$. \square

Lemma 6.2.23 (R—, 2023). *Let $\delta, \varepsilon \in (0, \infty)$, $q \in (2, \infty)$ and $\delta = \varepsilon(2^{q-1} + 1)^{-1}$. It is then the case for all $n \in \mathbb{N}_0$ and $x \in [a, b] \subsetneq \mathbb{R}$, where $0 \in [a, b] \subsetneq \mathbb{R}$ that:*

$$|e^x - \mathfrak{J}_\tau(\mathbf{Xpn}_n^{q,\varepsilon})(x)| \leq \sum_{i=0}^n \frac{1}{i!} (|x(x^{n-1} - \mathfrak{J}_\tau(\mathbf{Pwr}_{n-1}^{q,\varepsilon})(x))| + \varepsilon + |x|^q + \mathbf{p}_{n-1}^q) + \frac{e^b \cdot |x|^{n+1}}{(n+1)!} \quad (6.2.55)$$

Proof. Note that Taylor's theorem states that for $x \in [a, b] \subsetneq \mathbb{R}$ it is the case that:

$$e^x = \sum_{i=0}^n \left[\frac{x^i}{i!} \right] + \frac{e^\xi \cdot x^{n+1}}{(n+1)!} \quad (6.2.56)$$

Where ξ is between 0 and x in the Lagrange form of the remainder. Note then, for all $n \in \mathbb{N}_0$, $x \in [a, b] \subsetneq \mathbb{R}$, and ξ between 0 and x , it is the case, by monotonicity of e^x that the second summand is bounded by:

$$\frac{e^\xi \cdot x^{n+1}}{(n+1)!} \leq \frac{e^b \cdot |x|^{n+1}}{(n+1)!} \quad (6.2.57)$$

This, and the triangle inequality, then indicates that for all $x \in [a, b] \subsetneq \mathbb{R}$, and ξ between 0 and x that:

$$\begin{aligned} |e^x - \mathfrak{J}_\tau(\text{Xpn}_n^{q,\varepsilon})(x)| &= \left| \sum_{i=0}^n \left[\frac{x^i}{i!} \right] + \frac{e^\xi \cdot x^{n+1}}{(n+1)!} - \mathfrak{J}_\tau(\text{Xpn}_n^{q,\varepsilon})(x) \right| \\ &\leq \left| \sum_{i=0}^n \left[\frac{x^i}{i!} \right] - \mathfrak{J}_\tau(\text{Xpn}_n^{q,\varepsilon})(x) \right| + \frac{e^b \cdot |x|^{n+1}}{(n+1)!} \\ &\leq \sum_{i=1}^n \frac{1}{i!} (|x(x^{n-1} - \mathfrak{J}_\tau(\text{Pwr}_{n-1}^{q,\varepsilon})(x))| + \varepsilon + |x|^q + \mathfrak{p}_{n-1}^q) + \frac{e^b \cdot |x|^{n+1}}{(n+1)!} \end{aligned}$$

Whence we have that for fixed $n \in \mathbb{N}_0$ and $b \in [0, \infty)$, the last summand is constant, whence it is the case that:

$$|e^x - \mathfrak{J}_\tau(\text{Xpn}_n^{q,\varepsilon})(x)| \in \mathcal{O}(\varepsilon^{2q(n-1)}) \quad (6.2.58)$$

□

Definition 6.2.24 (The $\text{Csn}_n^{q,\varepsilon}$ Networks, and Neural Network Cosines). *Let $\delta, \varepsilon \in (0, \infty)$, $q \in (2, \infty)$ and $\delta = \varepsilon(2^{q-1} + 1)^{-1}$. Let $\text{Pwr}_n^{q,\varepsilon}$ be a neural networks as defined in Definition 6.2.7. We will define the neural networks $\text{Csn}_n^{q,\varepsilon}$ as:*

$$\text{Csn}_n^{q,\varepsilon} := \bigoplus_{i=0}^n \left[\frac{(-1)^i}{2i!} \triangleright \left[\text{Tun}_{\max_i \{D(\text{Pwr}_i^{q,\varepsilon})\} + 1 - D(\text{Pwr}_i^{q,\varepsilon}) \bullet \text{Pwr}_{2i}^{q,\varepsilon} \right] \right] \quad (6.2.59)$$

Lemma 6.2.25 (R—, 2023). *Let $\delta, \varepsilon \in (0, \infty)$, $q \in (2, \infty)$ and $\delta = \varepsilon(2^{q-1} + 1)^{-1}$. It is then the case for all $n \in \mathbb{N}_0$ and $x \in \mathbb{R}$ that:*

$$(i) \quad \mathfrak{J}_\tau(\text{Csn}_n^{q,\varepsilon})(x) \in C(\mathbb{R}, \mathbb{R})$$

$$(ii) \ D(\text{Csn}_n^{q,\varepsilon}) \leq \begin{cases} 1 & : n = 0 \\ 2n \left[\frac{q}{q-2} [\log_2(\varepsilon^{-1}) + q] - 1 \right] + 1 & : n \in \mathbb{N} \end{cases}$$

$$(iii) \ P(\text{Csn}_n^{q,\varepsilon}) \leq \begin{cases} 2 & : n = 0 \\ (2n+1) \left[4^{2n+\frac{3}{2}} + \left(\frac{4^{2n+1}-1}{3} \right) \left(\frac{360q}{q-2} [\log_2(\varepsilon^{-1}) + q + 1] + 372 \right) \right] & : n \in \mathbb{N} \end{cases}$$

$$(iv) \ \left| \sum_{i=0}^n \frac{(-1)^i}{2i!} x^{2i} - \mathfrak{J}_\tau(\text{Csn}_n^{q,\varepsilon})(x) \right| \leq \sum_{i=1}^n \left| \frac{(-1)^i}{2i!} \right| (|x| (x^{2i-1} - \mathfrak{J}_\tau(\text{Pwr}_{2i-1}^{q,\varepsilon})(x))| + \varepsilon + |x|^q + \mathfrak{p}_{2i-1}^q)$$

Where \mathfrak{p}_i are the set of functions defined for $i \in \mathbb{N}$ as such:

$$\begin{aligned} \mathfrak{p}_1 &= \varepsilon + 1 + |x|^2 \\ \mathfrak{p}_i &= \varepsilon + (\mathfrak{p}_{i-1})^2 + |x|^2 \end{aligned} \tag{6.2.60}$$

Whence it is the case that:

$$\left| \sum_{i=0}^n \frac{(-1)^i}{2i!} x^{2i} - \mathfrak{J}_\tau(\text{Csn}_n^{q,\varepsilon})(x) \right| \in \mathcal{O}(\varepsilon^{2q(2n-1)}) \tag{6.2.61}$$

Proof. Item (i) derives straightforwardly from Lemma 6.2.18. This proves Item (i).

Next, observe that since $\text{Csn}_n^{q,\varepsilon}$ will contain, as the deepest network in the summand, $\text{Pwr}_{2n}^{q,\varepsilon}$, we may then conclude that

$$\begin{aligned} D(\text{Csn}_n^{q,\varepsilon}) &\leq D(\text{Pwr}_{2n}^{q,\varepsilon}) \\ &\leq \begin{cases} 1 & : n = 0 \\ 2n \left[\frac{q}{q-2} [\log_2(\varepsilon^{-1}) + q] - 1 \right] + 1 & : n \in \mathbb{N} \end{cases} \end{aligned}$$

This proves Item (ii).

A similar argument to the above, Lemma 5.5.5, and Corollary 5.5.5.1 reveals that:

$$\begin{aligned}
\mathbb{P}(\text{Csn}_n^{q,\varepsilon}) &= \mathbb{P}\left(\bigoplus_{i=0}^n \left[\frac{(-1)^i}{2i!} \triangleright \left[\text{Tun}_{\max_i \{D(\text{Pwr}_i^{q,\varepsilon})\}} + 1 - D(\text{Pwr}_i^{q,\varepsilon}) \bullet \text{Pwr}_i^{q,\varepsilon} \right] \right]\right) \\
&\leq (n+1) \cdot \mathbb{P}(c_i \triangleright [\text{Tun}_1 \bullet \text{Pwr}_{2n}^{q,\varepsilon}]) \\
&\leq (n+1) \cdot \mathbb{P}(\text{Pwr}_{2n}^{q,\varepsilon}) \\
&\leq \begin{cases} 2 & : n = 0 \\ (n+1) \left[4^{2n+\frac{3}{2}} + \left(\frac{4^{2n+1}-1}{3} \right) \left(\frac{360q}{q-2} [\log_2(\varepsilon^{-1}) + q + 1] + 372 \right) \right] & : n \in \mathbb{N} \end{cases}
\end{aligned}$$

This proves Item (iii).

In a similar vein, we may argue from Lemma 6.2.18 and from the absolute homogeneity property of norms that:

$$\begin{aligned}
&\left| \sum_{i=0}^n \frac{(-1)^i}{2i!} x^{2i} - \mathfrak{J}_\tau(\text{Csn}_n^{q,\varepsilon}(x)) \right| \\
&= \left| \sum_{i=0}^n \frac{(-1)^i}{2i!} x^{2i} - \mathfrak{J}_\tau \left[\bigoplus_{i=0}^n \left[\frac{(-1)^i}{2i!} \triangleright \text{Tun}_{\max_{2i} \{D(\text{Pwr}_{2i}^{q,\varepsilon})\}} + 1 - D(\text{Pwr}_{2i}^{q,\varepsilon}) \bullet \text{Pwr}_{2i}^{q,\varepsilon} \right] \right] (x) \right| \\
&= \left| \sum_{i=1}^n \frac{(-1)^i}{2i!} x^{2i} - \sum_{i=0}^n \frac{(-1)^i}{2i!} \left(\mathfrak{J}_\tau \left[\text{Tun}_{\max_{2i} \{D(\text{Pwr}_{2i}^{q,\varepsilon})\}} + 1 - D(\text{Pwr}_{2i}^{q,\varepsilon}) \bullet \text{Pwr}_{2i}^{q,\varepsilon} \right] (x) \right) \right| \\
&\leq \sum_{i=1}^n \left| \frac{(-1)^i}{2i!} \right| \cdot \left| x^{2i} - \mathfrak{J}_\tau \left[\text{Tun}_{\max_{2i} \{D(\text{Pwr}_{2i}^{q,\varepsilon})\}} + 1 - D(\text{Pwr}_{2i}^{q,\varepsilon}) \bullet \text{Pwr}_{2i}^{q,\varepsilon} \right] (x) \right| \\
&\leq \sum_{i=1}^n \left| \frac{(-1)^i}{2i!} \right| \cdot \left(|x(x^{2i-1} - \mathfrak{J}_\tau(\text{Pwr}_{2i-1}^{q,\varepsilon}(x)))| + \varepsilon + |x|^q + \mathfrak{p}_{2i-1}^q \right)
\end{aligned}$$

Whence we have that:

$$\left| \sum_{i=0}^n \left[\frac{(-1)^i x^{2i}}{2i!} \right] - \mathfrak{J}_\tau(\text{Csn}_n^{q,\varepsilon}(x)) \right| \in \mathcal{O}\left(\varepsilon^{2q(2n-1)}\right) \tag{6.2.62}$$

This proves Item (iv). □

Lemma 6.2.26 (R—, 2023). *Let $\delta, \varepsilon \in (0, \infty)$, $q \in (2, \infty)$ and $\delta = \varepsilon(2^{q-1} + 1)^{-1}$. It is then the*

case for all $n \in \mathbb{N}_0$ and $x \in [a, b] \subseteq [0, \infty)$ that:

$$|\cos(x) - \mathfrak{J}_\tau(\text{Csn}_n^{q,\varepsilon})(x)| \leq \sum_{i=0}^n \frac{(-1)^i}{2i!} (|x(x^{n-1} - \mathfrak{J}_\tau(\text{Pwr}_{n-1}^{q,\varepsilon})(x))| + \varepsilon + |x|^q + \mathfrak{p}_{n-1}^q) + \frac{|x|^{n+1}}{(n+1)!}$$

Proof. Note that Taylor's theorem states that for all $x \in [a, b] \subsetneq \mathbb{R}$, where $0 \in [a, b]$, it is the case that:

$$\cos(x) = \sum_{i=0}^n \frac{(-1)^i}{2i!} x^i + \frac{\cos^{(n+1)}(\xi) \cdot x^{n+1}}{(n+1)!} \quad (6.2.63)$$

Note further that for all $n \in \mathbb{N}_0$, and $x \in \mathbb{R}$, it is the case that $\cos^{(n)}(x) \leq 1$. Whence we may conclude that for all $n \in \mathbb{N}_0$, $x \in [a, b] \subseteq \mathbb{R}$, where $0 \in [a, b]$ and ξ between 0 and x , we may bound the second summand by:

$$\frac{\cos^{(n+1)}(\xi) \cdot x^{n+1}}{(n+1)!} \leq \frac{|x|^{n+1}}{(n+1)!} \quad (6.2.64)$$

This, and the triangle inequality, then indicates that for all $x \in [a, b] \subsetneq [0, \infty)$ and $\xi \in [0, x]$:

$$\begin{aligned} |\cos(x) - \mathfrak{J}_\tau(\text{Csn}_n^{q,\varepsilon})(x)| &= \left| \sum_{i=0}^n \frac{(-1)^i}{2i!} x^i + \frac{\cos^{(n+1)}(\xi) \cdot x^{n+1}}{(n+1)!} - \mathfrak{J}_\tau(\text{Csn}_n^{q,\varepsilon})(x) \right| \\ &\leq \left| \sum_{i=0}^n \frac{(-1)^i}{2i!} x^i - \mathfrak{J}_\tau(\text{Csn}_n^{q,\varepsilon})(x) \right| + \frac{|x|^{n+1}}{(n+1)!} \\ &\leq \sum_{i=1}^n \left| \frac{(-1)^i}{2i!} \right| \cdot (|x(x^{2i-1} - \mathfrak{J}_\tau(\text{Pwr}_{2i-1}^{q,\varepsilon})(x))| + \varepsilon + |x|^q + \mathfrak{p}_{2i-1}^q) \\ &\quad + \frac{|x|^{n+1}}{(n+1)!} \end{aligned}$$

This completes the proof of the Lemma. □

Definition 6.2.27 (R—, 2023, The $\text{Sne}_n^{q,\varepsilon}$ Newtorks and Neural Network Sines). . Let $\delta, \varepsilon \in (0, \infty)$, $q \in (2, \infty)$ and $\delta = \varepsilon(2^{q-1} + 1)^{-1}$. Let $\text{Pwr}^{q,\varepsilon}$ be a neural network defined in Definition 6.2.7. We will define the neural network $\text{Csn}_{n,q,\varepsilon}$ as:

$$\text{Sne}_n^{q,\varepsilon} := \text{Csn}_n^{q,\varepsilon} \bullet \text{Aff}_{1, -\frac{\pi}{2}} \quad (6.2.65)$$

Lemma 6.2.28 (R—, 2023). *Let $\delta, \varepsilon \in (0, \infty)$, $q \in (2, \infty)$ and $\delta = \varepsilon (2^{q-1} + 1)^{-1}$. It is then the case for all $n \in \mathbb{N}_0$ and $x \in \mathbb{R}$ that:*

$$(i) \mathfrak{J}_\tau (\text{Sne}_n^{q,\varepsilon}) \in C(\mathbb{R}, \mathbb{R})$$

$$(ii) D(\text{Sne}_n^{q,\varepsilon}) \leq \begin{cases} 1 & : n = 0 \\ 2n \left[\frac{q}{q-2} [\log_2(\varepsilon^{-1}) + q] - 1 \right] + 1 & : n \in \mathbb{N} \end{cases}$$

$$(iii) P(\text{Sne}_n^{q,\varepsilon}) \leq \begin{cases} 2 & : n = 0 \\ (2n + 1) \left[4^{2n + \frac{3}{2}} + \left(\frac{4^{2n+1} - 1}{3} \right) \left(\frac{360q}{q-2} [\log_2(\varepsilon^{-1}) + q + 1] + 372 \right) \right] & : n \in \mathbb{N} \end{cases}$$

(iv)

$$\begin{aligned} & \left| \sum_{i=0}^n \frac{(-1)^i}{2i!} \left(x - \frac{\pi}{2}\right)^{2i} - \mathfrak{J}_\tau (\text{Sne}_n^{q,\varepsilon})(x) \right| \\ &= \left| \sum_{i=0}^n \frac{(-1)^i}{2i!} \left(x - \frac{\pi}{2}\right)^{2i} - \mathfrak{J}_\tau (\text{Csn}_n^{q,\varepsilon} \bullet \text{Aff}_{1, -\frac{\pi}{2}})(x) \right| \\ &\leq \sum_{i=1}^n \left| \frac{(-1)^i}{2i!} \right| \left(\left| \left(x - \frac{\pi}{2}\right) \left(\left(x - \frac{\pi}{2}\right)^{2i-1} - \mathfrak{J}_\tau (\text{Pwr}_{i-1}^{q,\varepsilon}) \left(x - \frac{\pi}{2}\right) \right) \right| + \varepsilon + |x|^q + \mathfrak{p}_{i-1}^q \right) \end{aligned}$$

Where \mathfrak{p}_i are the set of functions defined for $i \in \mathbb{N}$ as such:

$$\begin{aligned} \mathfrak{p}_1 &= \varepsilon + 1 + |x|^2 \\ \mathfrak{p}_i &= \varepsilon + (\mathfrak{p}_{i-1})^2 + |x|^2 \end{aligned} \tag{6.2.66}$$

Whence it is the case that:

$$\left| \sum_{i=0}^n \frac{(-1)^i}{2i!} \left(x - \frac{\pi}{2}\right)^{2i} - \mathfrak{J}_\tau (\text{Sne}_n^{q,\varepsilon})(x) \right| \in \mathcal{O} \left(\varepsilon^{2q(2n-1)} \right) \tag{6.2.67}$$

Proof. This follows straightforwardly from Lemma 6.2.25, and the fact that by Corollary 5.5.5.1, there is not a change to the parameter count, by Lemma 5.2.10, there is no change in depth,

by Lemma 5.5.2, and Lemma 6.2.25, continuity is preserved, and the fact that $\text{Aff}_{1, -\frac{\pi}{2}}$ is exact and hence contributes nothing to the error, and finally by the fact that $\text{Aff}_{1, -\frac{\pi}{2}} \rightarrow (\cdot) - \frac{\pi}{2}$ under instantiation, assures us that the $\text{Sne}_n^{q, \varepsilon}$ has the same error bounds as $\text{Csn}_n^{q, \varepsilon}$. \square

Lemma 6.2.29 (R—, 2023). *Let $\delta, \varepsilon \in (0, \infty)$, $q \in (2, \infty)$ and $\delta = \varepsilon (2^{q-1} + 1)^{-1}$. It is then the case for all $n \in \mathbb{N}_0$ and $x \in [a, b] \subseteq [0, \infty)$ that:*

$$\begin{aligned} & |\sin(x) - \mathfrak{J}_\tau(\text{Sne}_n^{q, \varepsilon})(x)| \\ & \leq \sum_{i=1}^n \left| \frac{(-1)^i}{2i!} \right| \left(\left| \left(x - \frac{\pi}{2} \right) \left(\left(x - \frac{\pi}{2} \right)^{2i-1} - \mathfrak{J}_\tau(\text{Pwr}_{i-1}^{q, \varepsilon}) \left(x - \frac{\pi}{2} \right) \right) \right| + \varepsilon + |x|^q + \mathfrak{p}_{i-1}^q \right) \\ & + \frac{|x|^{n+1}}{(n+1)!} \end{aligned} \tag{6.2.68}$$

Proof. Note that the fact that $\sin(x) = \cos(x - \frac{\pi}{2})$, Lemma 5.2.5, and Lemma 5.5.2 then renders (6.2.68) as:

$$\begin{aligned} & |\sin(x) - \mathfrak{J}_\tau(\text{Sne}_n^{q, \varepsilon})| \\ & = \left| \cos\left(x - \frac{\pi}{2}\right) - \mathfrak{J}_\tau\left(\text{Csn}_n^{q, \varepsilon} \bullet \text{Aff}_{1, -\frac{\pi}{2}}\right)(x) \right| \\ & = \left| \cos\left(x - \frac{x}{2}\right) - \mathfrak{J}_\tau \text{Csn}_n^{q, \varepsilon}\left(x - \frac{\pi}{2}\right) \right| \\ & \leq \sum_{i=1}^n \left| \frac{(-1)^i}{2i!} \right| \left(\left| \left(x - \frac{\pi}{2} \right) \left(\left(x - \frac{\pi}{2} \right)^{2i-1} - \mathfrak{J}_\tau(\text{Pwr}_{i-1}^{q, \varepsilon}) \left(x - \frac{\pi}{2} \right) \right) \right| + \varepsilon + |x|^q + \mathfrak{p}_{i-1}^q \right) + \frac{|x|^{n+1}}{(n+1)!} \end{aligned}$$

\square

Remark 6.2.30. *Note that under these neural network architectures the famous Pythagorean identity $\sin^2(x) + \cos^2(x) = 1$, may be rendered approximately, for fixed n, q, ε as: $[\text{Sqr}^{q, \varepsilon} \bullet \text{Csn}_n^{q, \varepsilon}] \oplus [\text{Sqr}^{q, \varepsilon} \bullet \text{Sne}_n^{q, \varepsilon}]$. A full discussion of the associated parameter, depth, and accuracy bounds are beyond the scope of this dissertation, and may be appropriate for future work.*

Chapter 7

A modified Multi-Level Picard and Associated Neural Network

We now look at neural networks in the context of multi-level Picard iterations.

Lemma 7.0.1. *Let $\alpha, \beta, M \in [0, \infty)$, $U_n \in [0, \infty)$, for $n \in \mathbb{N}_0$ satisfy for all $n \in \mathbb{N}$ that:*

$$U_n \leq \alpha M^n + \sum_{i=0}^{n-1} M^{n-i} (\max\{\beta, U_i\} + \mathbb{1}_{\mathbb{N}}(i) \max\{\beta, U_{\max\{i-1, 0\}}\}) \quad (7.0.1)$$

It is then also the case that for all $n \in \mathbb{N}$ that $U_n \leq (2M + 1)^n \max\{\alpha, \beta\}$.

Proof. Let:

$$S_n = M^n + \sum_{i=0}^{n-1} M^{n-i} \left[(2M + 1)^i + \mathbb{1}_{\mathbb{N}}(i) (2M + 1)^{\max\{i-1, 0\}} \right] \quad (7.0.2)$$

We prove this by induction. The base case of $n = 0$ already implies that $U_0 \leq \alpha \leq \max\{\alpha, \beta\}$.

Next assume that $U_n \leq (2M + 1)^n \max\{\alpha, \beta\}$ holds for all integers upto and including n , it is then

the case that:

$$\begin{aligned}
U_{n+1} &\leq \alpha M^{n+1} + \sum_{i=0}^n M^{n+1-i} (\max\{\beta, U_i\} + \mathbb{1}_{\mathbb{N}}(i) \max\{\beta, U_{\max\{i-1,0\}}\}) \\
&\leq \alpha M^{n+1} + \sum_{i=0}^n M^{n+1-i} \left[\max\left\{ \beta, (2M+1)^k \max\{\alpha, \beta\} \right\} \right. \\
&\quad \left. + \mathbb{1}_{\mathbb{N}}(i) \max\left\{ \beta, (2M+1)^{\max\{k-1,0\}} \max\{\alpha, \beta\} \right\} \right] \\
&\leq \alpha M^{n+1} + \max\{\alpha, \beta\} \sum_{i=0}^n M^{n+1-i} \left[(2M+1)^i + \mathbb{1}_{\mathbb{N}}(i) (2M+1)^{\max\{i-1,0\}} \right] \\
&\leq \max\{\alpha, \beta\} S_{n+1}
\end{aligned} \tag{7.0.3}$$

Then (7.0.2) and the assumption that $M \in [0, \infty)$ tells us that:

$$\begin{aligned}
S_{n+1} &= M^{n+1} + \sum_{i=0}^n M^{n+1-i} \left[(2M+1)^i + \mathbb{1}_{\mathbb{N}}(i) (2M+1)^{\max\{i-1,0\}} \right] \\
&= M^{n+1} \sum_{i=0}^n M^{n+1-i} (2M+1)^k + \sum_{i=1}^n M^{n+1-i} (2M+1)^{i-1} \\
&= M^{n+1} + M \left[\frac{(2M+1)^{n+1} - M^{n+1}}{M+1} \right] + M \left[\frac{(2M+1)^n - M^n}{M+1} \right] \\
&= M^{n+1} + \frac{M(2M+1)^{n+1}}{M+1} + \frac{(2M+1)^n}{M+1} - M \left[\frac{M^{n+1} + M^n}{M+1} \right] \\
&\leq M^{n+1} + \frac{M(2M+1)^{n+1}}{M+1} + \frac{(2M+1)^{n+1}}{M+1} - M^{n+1} \left[\frac{M+1}{M+1} \right] \\
&= (2M+1)^{n+1}
\end{aligned} \tag{7.0.4}$$

This completes the induction step proving (7.0.1). \square

Lemma 7.0.2. *Let $\Theta = \left(\bigcup^{n \in \mathbb{N}} \mathbb{Z}^n \right)$, $d, M \in \mathbb{N}$, $T \in (0, \infty)$, $f \in C(\mathbb{R}, \mathbb{R})$, $g \in C(\mathbb{R}^d, \mathbb{R})$, $F, G \in \text{NN}$ satisfy that $\mathfrak{I}_{\tau}(F) = f$ and $\mathfrak{I}_{\tau}(G) = g$, let $\mathbf{u}^\theta \in [0, 1]$, $\theta \in \Theta$, and $\mathcal{U}^\theta : [0, T] \rightarrow [0, T]$, $\theta \in \Theta$, satisfy for all $t \in [0, T]$, $\theta \in \Theta$ that $\mathcal{U}_t^\theta = t + (T-t)\mathbf{u}^\theta$, let $\mathcal{W}^\theta : [0, T] \rightarrow \mathbb{R}^d$, $\theta \in \Theta$, for every $\theta \in \Theta$, $t \in [0, T]$, $s \in [t, T]$, let $\mathcal{Y}_{t,s}^\theta \in \mathbb{R}$ satisfy $\mathcal{Y}_{t,s}^\theta = \mathcal{W}_s^\theta - \mathcal{W}_t^\theta$ and let $\mathcal{U}_n^\theta : [0, T] \times \mathbb{R}^d \rightarrow \mathbb{R}$,*

$n \in \mathbb{N}_0$, $\theta \in \Theta$, satisfy for all $\theta \in \Theta$, $n \in \mathbb{N}_0$, $t \in [0, T]$, $x \in \mathbb{R}^d$ that:

$$U_n^\theta(t, x) = \frac{\mathbb{1}_{\mathbb{N}}(n)}{M^n} \left[\sum_{k=1}^{M^n} g \left(x + \mathcal{Y}_{t,T}^{(\theta,0,-k)} \right) \right] + \sum_{i=0}^{n-1} \frac{T-t}{M^{n-i}} \left[\sum_{k=1}^{M^{n-i}} \left(\left(f \circ U_i^{(\theta,i,k)} \right) - \mathbb{1}_{\mathbb{N}}(i) \left(f \circ U_{\max\{i-1,0\}}^{(\theta,-i,k)} \right) \right) \left(\mathcal{U}_t^{(\theta,i,k)}, x + \mathcal{Y}_{t,\mathcal{U}_t^{(\theta,i,k)}}^{(\theta,i,k)} \right) \right] \quad (7.0.5)$$

it is then the case that:

(i) there exists unique $U_{n,t}^\theta \in \mathbb{NN}$, $t \in [0, T]$, $n \in \mathbb{N}_0$, $\theta \in \Theta$, which satisfy for all $\theta_1, \theta_2 \in \Theta$, $n \in \mathbb{N}_0$, $t_1, t_2 \in [0, T]$ that $L(U_{n,t_1}^{\theta_1}) = L(U_{n,t_2}^{\theta_2})$.

(ii) for all $\theta \in \Theta$, $t \in [0, T]$ that $U_{0,t}^\theta = [[0 \ 0 \ \dots \ 0], [0]] \in \mathbb{R}^{1 \times d} \times \mathbb{R}^1$

(iii) for all $\theta \in \Theta$, $n \in \mathbb{N}$, $t \in [0, T]$ that:

$$U_{n,t}^\theta = \left[\bigoplus_{k=1}^{M^n} \left(\frac{1}{M^n} \otimes \left(G \bullet \text{Aff}_{\mathbb{I}_d, \mathcal{Y}_{t,T}^{(\theta,0,-k)}} \right) \right) \right] \boxplus_{\mathbb{I}} \left[\boxplus_{i=0, \mathbb{I}}^{n-1} \left[\left(\frac{T-t}{M^{n-i}} \right) \otimes \left(\boxplus_{k=1, \mathbb{I}}^{M^{n-i}} \left(\left(F \bullet U_{i, \mathcal{U}_t^{(\theta,i,k)}}^{(\theta,i,k)} \right) \bullet \text{Aff}_{\mathbb{I}_d, \mathcal{Y}_{t, \mathcal{U}_t^{(\theta,i,k)}}^{(\theta,i,k)}} \right) \right) \right] \right] \boxplus_{\mathbb{I}} \left[\boxplus_{i=0, \mathbb{I}}^{n-1} \left[\left(\frac{(t-T)\mathbb{1}_{\mathbb{N}}}{M^{n-i}} \right) \otimes \left(\boxplus_{k=1, \mathbb{I}}^{M^{n-i}} \left(\left(F \bullet U_{\max\{i-1,0\}, \mathcal{U}_t^{(\theta,i,k)}}^{(\theta,-i,k)} \right) \bullet \text{Aff}_{\mathbb{I}_d, \mathcal{Y}_{t, \mathcal{U}_t^{(\theta,i,k)}}^{(\theta,i,k)}} \right) \right) \right] \right] \quad (7.0.6)$$

(iv) that for all $\theta \in \Theta$, $n \in \mathbb{N}_0$, $t \in [0, T]$, that $D(U_{n,t}^\theta) = n \cdot H(F) + \max\{1, \mathbb{1}_{\mathbb{N}}(n) D(G)\}$

(v) that for all $\theta \in \Theta$, $n \in \mathbb{N}_0$, $t \in [0, T]$, that $\|L(U_{n,t}^\theta)\|_{\max} \leq (2M+1)^n \max\{2, \|L(F)\|_{\max}, \|L(G)\|_F\}$

(vi) it holds for all $\theta \in \Theta$, $n \in \mathbb{N}_0$, $t \in [0, T]$, $x \in \mathbb{R}^d$ that $U_n^\theta(t, x) = (\mathfrak{J}_\tau(U_{n,t}^\theta))(x)$, and

(vii) it holds for all $\theta \in \Theta$, $n \in \mathbb{N}_0$, $t \in [0, T]$ that:

$$P(U_{n,t}^\theta) \leq 2n H(F) + \max\{1, \mathbb{1}_{\mathbb{N}}(n) D(G)\} [(2M+1)^n \max\{2, \|L(F)\|_{\max}, \|L(G)\|_{\max}\}]^2 \quad (7.0.7)$$

Chapter 8

ANN first approximations

8.1 ANN Representations for One-Dimensional Identity and some associated properties

Definition 8.1.1 (One Dimensional Identity Neural Network). *We will denote by $\text{Id}_d \in \text{NN}$ the neural network satisfying for all $d \in \mathbb{N}$ that:*

(i)

$$\text{Id}_1 = \left(\left(\begin{bmatrix} 1 \\ -1 \end{bmatrix}, \begin{bmatrix} 0 \\ 0 \end{bmatrix} \right) \left(\begin{bmatrix} 1 & -1 \end{bmatrix}, \begin{bmatrix} 0 \end{bmatrix} \right) \right) \in ((\mathbb{R}^{2 \times 1} \times \mathbb{R}^2) \times (\mathbb{R}^{1 \times 2} \times \mathbb{R}^1)) \quad (8.1.1)$$

(ii)

$$\text{Id}_d = \boxplus_{i=1}^d \text{Id}_1 \quad (8.1.2)$$

For $d > 1$.

Lemma 8.1.2. *Let $d \in \mathbb{N}$, it is then the case that:*

(i) $\mathsf{L}(\text{Id}_d) = (d, 2d, d) \in \mathbb{N}^3$.

(ii) $\mathfrak{J}_r(\text{Id}_d) \in C(\mathbb{R}^d, \mathbb{R}^d)$.

(iii) For all $x \in \mathbb{R}^d$ that:

$$(\mathfrak{J}_\tau(\text{Id}_d))(x) = x$$

(iv) For $d \in \mathbb{N}$ it is the case that $\text{D}(\text{Id}_d) = 2$

Proof. Note that (8.1.1) ensure that $\text{L}(\text{Id}_d) = (1, 2, 1)$. Furthermore, (8.1.2) and Remark 5.3.12 prove that $\text{L}(\text{Id}_d) = (d, 2d, d)$ which in turn proves Item (i). Note now that Remark 5.3.12 tells us that:

$$\text{Id}_d = \boxtimes_{i=1}^d (\text{Id}_1) \in \left(\prod_{i=1}^L \left[\mathbb{R}^{d_i \times d_{i-1}} \times \mathbb{R}^{d_i} \right] \right) = \left(\left(\mathbb{R}^{2d \times d} \times \mathbb{R}^{2d} \right) \times \left(\mathbb{R}^{d \times 2d} \times \mathbb{R}^d \right) \right) \quad (8.1.3)$$

Note that 8.1.1 ensures that for all $x \in \mathbb{R}$ it is the case that:

$$(\mathfrak{J}_\tau(\text{Id}_1))(x) = \mathfrak{r}(x) - \mathfrak{r}(-x) = \max\{x, 0\} - \max\{-x, 0\} = x \quad (8.1.4)$$

And Lemma 5.3.8 shows us that for all $x = (x_1, x_2, \dots, x_d) \in \mathbb{R}^d$ it is the case that $\mathfrak{J}_\tau(\text{Id}_d) \in C(\mathbb{R}^d, \mathbb{R}^d)$ and that:

$$\begin{aligned} (\mathfrak{J}_\alpha(\text{Id}_d))(x) &= \left(\mathfrak{J}_\alpha \left(\boxtimes_{i=1}^d (\text{Id}_1) \right) \right) (x_1, x_2, \dots, x_d) \\ &= ((\mathfrak{J}_\alpha(\text{Id}_1))(x_1), (\mathfrak{J}_\alpha(\text{Id}_1))(x_1), \dots, (\mathfrak{J}_\alpha(\text{Id}_1))(x_d)) \\ &= (x_1, x_2, \dots, x_d) = x \end{aligned} \quad (8.1.5)$$

This proves Item (ii)—(iii). Item (iv) follows straightforwardly from Item (i). This establishes the lemma. \square

Remark 8.1.3. Note here the difference between Definition ?? and Definition 8.1.1.

Lemma 8.1.4 (R—, 2023). Let $d \in \mathbb{N}$. It then the case that for all $d \in \mathbb{N}$ we have that $\text{P}(\text{Id}_d) = 4d^2 + 3d$

Proof. By observation we have that $\text{P}(\text{Id}_1) = 4(1)^2 + 3(1) = 7$. By induction, suppose that this holds for all natural numbers up to and including n , i.e., for all naturals up to and including n ; it

is the case that $P(id_n) = 4n^2 + 3n$. Note then that $\text{ld}_{n+1} = \text{ld}_n \boxplus \text{ld}_1$. For W_1 and W_2 of this new network, this adds a combined extra $8n + 4$ parameters. For b_1 and b_2 of this new network, this adds a combined extra 3 parameters. Thus, we have the following:

$$4n^2 + 3n + 8n + 4 + 3 = 4(n + 1)^2 + 3(n + 1) \quad (8.1.6)$$

This completes the induction and hence proves the Lemma. \square

Lemma 8.1.5. *Let $\nu \in \text{NN}$ with end-widths d . It is then the case that $\mathfrak{J}_\tau(\text{ld}_d \bullet \nu)(x) = \mathfrak{J}_\tau(\nu \bullet \text{ld}_d) = \mathfrak{J}_\tau(\nu)$, i.e. ld_d acts as a compositional identity.*

Proof. From (5.2.1) and Definition 8.1.1 we have eight cases.

Case 1 where $d = 1$ and subcases:

(1.i) $\text{ld}_d \bullet \nu$ where $D(\nu) = 1$

(1.ii) $\text{ld}_d \bullet \nu$ where $D(\nu) > 1$

(1.iii) $\nu \bullet \text{ld}_d$ where $D(\nu) = 1$

(1.iv) $\nu \bullet \text{ld}_d$ where $D(\nu) > 1$

Case 2 where $d > 1$ and subcases:

(2.i) $\text{ld}_d \bullet \nu$ where $D(\nu) = 1$

(2.ii) $\text{ld}_d \bullet \nu$ where $D(\nu) > 1$

(2.iii) $\nu \bullet \text{ld}_d$ where $D(\nu) = 1$

(2.iv) $\nu \bullet \text{ld}_d$ where $D(\nu) > 1$

Case 1.i: Let $\nu = ((W_1, b_1))$. Deriving from Definitions 8.1.1 and 5.2.1 we have that:

$$\text{ld}_1 \bullet \nu = \left(\left(\left(\begin{bmatrix} 1 \\ -1 \end{bmatrix} W_1, \begin{bmatrix} 1 \\ -1 \end{bmatrix} b_1 + \begin{bmatrix} 0 \\ 0 \end{bmatrix} \right), \left(\begin{bmatrix} 1 & -1 \end{bmatrix}, \begin{bmatrix} 0 \end{bmatrix} \right) \right) \right) \quad (8.1.7)$$

$$= \left(\left(\left(\begin{bmatrix} W_1 \\ -W_1 \end{bmatrix}, \begin{bmatrix} b_1 \\ -b_1 \end{bmatrix} \right), \left(\begin{bmatrix} 1 & -1 \end{bmatrix}, \begin{bmatrix} 0 \end{bmatrix} \right) \right) \right) \quad (8.1.8)$$

Let $x \in \mathbb{R}$. Upon instantiation with τ and $d = 1$ we have:

$$\begin{aligned}
(\mathfrak{I}_\tau(\text{ld}_1 \bullet \nu))(x) &= \tau(W_1x + b_1) - \tau(-W_1x - b_1) \\
&= \max\{W_1x + b_1, 0\} - \max\{-W_1x - b_1, 0\} \\
&= W_1x + b_1 \\
&= \mathfrak{I}_\tau(\nu)
\end{aligned}$$

Case 1.ii: Let $\nu = ((W_1, b_1), (W_2, b_2), \dots, (W_L, b_L))$. Deriving from Definition 8.1.1 and 5.2.1 we have that:

$$\begin{aligned}
\text{ld}_1 \bullet \nu &= \left((W_1, b_1), (W_2, b_2), \dots, (W_{L-1}, b_{L-1}), \left(\begin{bmatrix} 1 \\ -1 \end{bmatrix} W_L, \begin{bmatrix} 1 \\ -1 \end{bmatrix} b_L + \begin{bmatrix} 0 \\ 0 \end{bmatrix} \right), \left(\begin{bmatrix} 1 & -1 \end{bmatrix}, \begin{bmatrix} 0 \end{bmatrix} \right) \right) \\
&= \left((W_1, b_1), (W_2, b_2), \dots, (W_{L-1}, b_{L-1}), \left(\begin{bmatrix} W_L \\ -W_L \end{bmatrix}, \begin{bmatrix} b_L \\ -b_L \end{bmatrix} \right), \left(\begin{bmatrix} 1 & -1 \end{bmatrix}, \begin{bmatrix} 0 \end{bmatrix} \right) \right)
\end{aligned}$$

Let $x \in \mathbb{R}$. Note that upon instantiation with τ , the last two layers are:

$$\begin{aligned}
&\tau(W_Lx + b_L) - \tau(-W_Lx - b_L, 0) \\
&= \max\{W_Lx + b_L, 0\} - \max\{-W_Lx - b_L, 0\} \\
&= W_Lx + b_L
\end{aligned} \tag{8.1.9}$$

This, along with Case 1. i, implies that the uninstantiated last layer is equivalent to (W_L, b_L) whence $\text{ld}_1 \bullet \nu = \nu$.

Case 1.iii: Let $\nu = ((W_1, b_1))$. Deriving from Definition 8.1.1 and 5.2.1 we have:

$$\begin{aligned}
\nu \bullet \text{ld}_1 &= \left(\left(\begin{bmatrix} 1 \\ -1 \end{bmatrix}, \begin{bmatrix} 0 \\ 0 \end{bmatrix} \right), \left(W_1 \begin{bmatrix} 1 & -1 \end{bmatrix}, W_1 \begin{bmatrix} 0 \end{bmatrix} + b_1 \right) \right) \\
&= \left(\left(\begin{bmatrix} 1 \\ -1 \end{bmatrix}, \begin{bmatrix} 0 \\ 0 \end{bmatrix} \right), \left(\begin{bmatrix} W_1 & -W_1 \end{bmatrix}, b_1 \right) \right)
\end{aligned}$$

Let $x \in \mathbb{R}$. Upon instantiation with \mathfrak{r} we have that:

$$\begin{aligned}
(\mathfrak{J}_{\mathfrak{r}}(\nu \bullet \text{Id}_1))(x) &= \begin{bmatrix} W_1 & -W_1 \end{bmatrix} \mathfrak{r} \left(\begin{bmatrix} x \\ -x \end{bmatrix} \right) + b_1 \\
&= W_1 \mathfrak{r}(x) - W_1 \mathfrak{r}(-x) + b_1 \\
&= W_1 (\mathfrak{r}(x) - \mathfrak{r}(-x)) + b_1 \\
&= W_x + b_1 = \mathfrak{J}_{\mathfrak{r}}(\nu)
\end{aligned} \tag{8.1.10}$$

Case 1.iv: Let $\nu = ((W_1, b_1), (W_2, b_2), \dots, (W_L, b_L))$. Deriving from Definitions 8.1.1 and 5.2.1 we have that:

$$\nu \bullet \text{Id}_1 = \left(\left(\begin{bmatrix} 1 \\ -1 \end{bmatrix}, \begin{bmatrix} 0 \\ 0 \end{bmatrix} \right), \left(\begin{bmatrix} W_1 & -W_1 \end{bmatrix}, b_1 \right), (W_2, b_2), \dots, (W_L, b_L) \right) \tag{8.1.11}$$

Let $x \in \mathbb{R}$. Upon instantiation with \mathfrak{r} , we have that the first two layers are:

$$\begin{aligned}
&\begin{bmatrix} W_1 & -W_1 \end{bmatrix} \mathfrak{r} \left(\begin{bmatrix} x \\ -x \end{bmatrix} \right) + b_1 \\
&= W_1 \mathfrak{r}(x) - W_1 \mathfrak{r}(-x) + b_1 \\
&= W_1 (\mathfrak{r}(x) - \mathfrak{r}(-x)) + b_1 \\
&= W_1 x + b_1 = \mathfrak{J}_{\mathfrak{r}}(\nu)
\end{aligned} \tag{8.1.12}$$

This, along with Case 1. iii, implies that the uninstantiated first layer is equivalent (W_1, b_1) whence we have that $\nu \bullet \text{Id}_1 = \nu$.

Observe that Definitions 5.3.1 and 8.1.1 tells us that:

$$\boxplus_{i=1}^d \text{Id}_i = \left(\left(\left(\overbrace{\begin{bmatrix} \text{Weight}_{\text{Id}_1,1} & & \\ & \ddots & \\ & & \text{Weight}_{\text{Id}_1,1} \end{bmatrix}}^{d\text{-many}} \right), \mathbf{0}_{2d} \right), \left(\left(\overbrace{\begin{bmatrix} \text{Weight}_{\text{Id}_1,2} & & \\ & \ddots & \\ & & \text{Weight}_{\text{Id}_1,2} \end{bmatrix}}^{d\text{-many}} \right), \mathbf{0}_d \right) \right)$$

Case 2.i Let $d \in \mathbb{N} \cap [1, \infty)$. Let $\nu \in \text{NN}$ be $\nu = (W_1, b_1)$ with end-widths d . Deriving from Definitions 5.2.1 and 8.1.1 we have:

$$\begin{aligned} \text{Id}_d \bullet \nu &= \left(\left(\left(\begin{bmatrix} \text{Weight}_{\text{Id}_1,1} & & \\ & \ddots & \\ & & \text{Weight}_{\text{Id}_1,1} \end{bmatrix} W_1, \begin{bmatrix} \text{Weight}_{\text{Id}_1,1} & & \\ & \ddots & \\ & & \text{Weight}_{\text{Id}_1,1} \end{bmatrix} b_1 \right), \left(\begin{bmatrix} \text{Weight}_{\text{Id}_1,2} & & \\ & \ddots & \\ & & \text{Weight}_{\text{Id}_1,2} \end{bmatrix}, \mathbf{0}_d \right) \right) \\ &= \left(\left(\left(\begin{bmatrix} [W_1]_{1,*} \\ -[W_1]_{1,*} \\ \vdots \\ [W_1]_{d,*} \\ -[W_1]_{d,*} \end{bmatrix}, \begin{bmatrix} [b_1]_1 \\ -[b_1]_1 \\ \vdots \\ [b_1]_d \\ -[b_1]_d \end{bmatrix} \right), \left(\begin{bmatrix} \text{Weight}_{\text{Id}_1,2} & & \\ & \ddots & \\ & & \text{Weight}_{\text{Id}_1,2} \end{bmatrix}, \mathbf{0}_d \right) \right) \end{aligned}$$

Let $x \in \mathbb{R}^d$. Upon instantiation with τ we have that:

$$\begin{aligned} &(\mathfrak{J}_\tau(\text{Id}_d \bullet \nu))(x) \\ &= \tau([W_1]_{1,*} \cdot x + [b_1]_1) - \tau(-[W_1]_{1,*} \cdot x - [b_1]_1) + \cdots \\ &+ \tau([W_1]_{d,*} \cdot x + [b_1]_d) - \tau(-[W_1]_{d,*} \cdot x - [b_1]_d) \\ &= [W_1]_{1,*} \cdot x + [b_1]_1 + \cdots + [W_1]_{d,*} \cdot x + [b_1]_d \\ &= W_1 x + b_1 = \mathfrak{J}_\tau(\nu) \end{aligned}$$

Case 2.ii: Let $\nu = ((W_1, b_1), (W_2, b_2), \dots, (W_L, b_L))$. Deriving from Definition 8.1.1 and 5.2.1 we have that:

$$\text{Id}_d \bullet \nu = \left((W_1, b_1), (W_2, b_2), \dots, (W_{L-1}, b_{L-1}), \left(\begin{bmatrix} [W_L]_{1,*} \\ -[W_L]_{1,*} \\ \vdots \\ [W_L]_{d,*} \\ -[W_L]_{d,*} \end{bmatrix}, \begin{bmatrix} [b_L]_1 \\ -[b_L]_1 \\ \vdots \\ [b_L]_d \\ -[b_L]_d \end{bmatrix} \right), \left(\begin{bmatrix} 1 & -1 \\ 0 \end{bmatrix} \right) \right)$$

Note that upon instantiation with τ , the last two layers become:

$$\begin{aligned} & \tau([W_L]_{1,*} \cdot x + [b_L]_1) - \tau(-[W_L]_{1,*} \cdot x - [b_L]_1) + \dots \\ & + \tau([W_L]_{d,*} \cdot x + [b_L]_d) - \tau(-[W_L]_{d,*} \cdot x - [b_L]_d) \\ & = [W_L]_{1,*} \cdot x + [b_L]_1 + \dots + [W_L]_{d,*} \cdot x + [b_L]_d \\ & = W_L x + b_L \end{aligned} \tag{8.1.13}$$

This, along with Case 2.i implies that the uninstantiated last layer is equivalent to (W_L, b_L) whence $\text{Id}_d \bullet \nu = \nu$.

Case 2.iii: Let $\nu = ((W_1, b_1))$. Deriving from Definition 8.1.1 and 5.2.1 we have:

$$\begin{aligned} & \nu \bullet \text{Id}_d \\ & = \left(\left(\begin{bmatrix} \text{Weight}_{\text{Id}_1,1} & & \\ & \ddots & \\ & & \text{Weight}_{\text{Id}_1,1} \end{bmatrix}, \mathbb{0}_{2d} \right), \left(W_1 \begin{bmatrix} \text{Weight}_{\text{Id}_1,2} & & \\ & \ddots & \\ & & \text{Weight}_{\text{Id}_1,2} \end{bmatrix}, b_1 \right) \right) \end{aligned}$$

Upon instantiation with \mathfrak{r} we have that:

$$(\mathfrak{J}_{\mathfrak{r}}(\nu))(x) \tag{8.1.14}$$

$$\begin{aligned}
&= \left[[W_1]_{*,1} \quad -[W_1]_{*,1} \quad \cdots \quad [W_1]_{*,d} \quad -[W_1]_{*,d} \right] \mathfrak{r} \begin{pmatrix} [x]_1 \\ -[x]_1 \\ \vdots \\ [x]_d \\ -[x]_d \end{pmatrix} + b_1 \\
&= [W_1]_{*,1} \mathfrak{r}([x]_1) - [W_1]_{*,1} \mathfrak{r}(-[x]_1) + \cdots + [W_1]_{*,d} \mathfrak{r}([x]_d) - [W_1]_{*,d} \mathfrak{r}(-[x]_d) + b_1 \\
&= [W_1]_{*,1} \cdot [x]_1 + \cdots + [W_1]_{*,d} \cdot [x]_d \\
&= W_1 x + b_1 = \mathfrak{J}_{\mathfrak{r}}(\nu) \tag{8.1.15}
\end{aligned}$$

Case 2.iv: Let $\nu = ((W_1, b_1), (W_2, b_2), \dots, (W_L, b_L))$. Deriving from Definitions 8.1.1 and 5.2.1 we have:

$$\begin{aligned}
&\nu \bullet \text{Id}_d \\
&= \left(\left(\left(\begin{bmatrix} \text{Weight}_{\text{Id}_1,1} & & & \\ & \ddots & & \\ & & \text{Weight}_{\text{Id}_1,1} & \\ & & & \end{bmatrix}, \mathbb{0}_{2d} \right), \left(\begin{bmatrix} [W_1]_{*,1} & -[W_1]_{*,1} & \cdots & [W_1]_{*,d} & -[W_1]_{*,d} \end{bmatrix}, b_1 \right), \dots \right. \\
&\quad \left. (W_2, b_2), \dots, (W_L, b_L) \right)
\end{aligned}$$

Upon instantiation with τ , we have that the first two layers are:

$$(\mathcal{J}_\tau(\nu))(x) \tag{8.1.16}$$

$$\begin{aligned} &= \left[[W_1]_{*,1} \quad -[W_1]_{*,1} \quad \cdots \quad [W_1]_{*,d} \quad -[W_1]_{*,d} \right] \tau \begin{pmatrix} [x]_1 \\ -[x]_1 \\ \vdots \\ [x]_d \\ -[x]_d \end{pmatrix} + b_1 \\ &= [W_1]_{*,1} \tau([x]_1) - [W_1]_{*,1} \tau(-[x]_1) + \cdots + [W_1]_{*,d} \tau([x]_d) - [W_1]_{*,d} \tau(-[x]_d) + b_1 \\ &= [W_1]_{*,1} \cdot [x]_1 + \cdots + [W_1]_{*,d} \cdot [x]_d \\ &= W_1 x + b_1 \end{aligned} \tag{8.1.17}$$

This, along with Case 2. iii, implies that the uninstantiated first layer is equivalent to (W_L, b_L) whence $\text{Id}_d \bullet \nu = \nu$.

This completes the proof. \square

Definition 8.1.6 (Monoid). *Given a set X with binary operation $*$, we say that X is a monoid under the operation $*$ if:*

- (i) *For all $x, y \in X$ it is the case that $x * y \in X$*
- (ii) *For all $x, y, z \in X$ it is the case that $(x * y) * z = x * (y * z)$*
- (iii) *There exists a unique element $e \in X$ such that $e * x = x * e = x$*

Theorem 8.1.7. *Let $d \in \mathbb{N}$. For a fixed d , the set of all neural networks $\nu \in \text{NN}$ with instantiations in τ and end-widths d form a monoid under the operation of \bullet .*

Proof. This is a consequence of Lemma 8.1.5 and Lemma 5.2.4. \square

Remark 8.1.8. *By analogy with matrices, we may find it helpful to refer to neural networks of end-widths d as ‘‘square neural networks of size d ’’.*

8.2 Trp^h , $\text{Etr}^{n,h}$ and Neural Network Approximations For the Trapezoidal Rule.

Definition 8.2.1 (The Trp neural network). Let $h \in \mathbb{R}_{\geq 0}$. We define the $\text{Trp}^h \in \text{NN}$ neural network as:

$$\text{Trp}^h := \text{Aff}_{\left[\frac{h}{2}, \frac{h}{2}\right], 0} \quad (8.2.1)$$

Lemma 8.2.2. Let $h \in (-\infty, \infty)$. It is then the case that:

(i) for $x = \{x_1, x_2\} \in \mathbb{R}^2$ that $(\mathcal{J}_\tau(\text{Trp}^h))(x) \in C(\mathbb{R}^2, \mathbb{R})$

(ii) for $x = \{x_1, x_2\} \in \mathbb{R}^2$ that $(\mathcal{J}_\tau(\text{Trp}^h))(x) = \frac{1}{2}h(x_1 + x_2)$

(iii) $D(\text{Trp}^h) = 1$

(iv) $P(\text{Trp}^h) = 3$

(v) $L(\text{Trp}^h) = (2, 1)$

Proof. This a straight-forward consequence of Lemma 5.5.1 □

Definition 8.2.3 (The Etr neural network). Let $n \in \mathbb{N}$ and $h \in \mathbb{R}_{\geq 0}$. We define the neural network $\text{Etr}^{n,h} \in \text{NN}$ as:

$$\text{Etr}^{n,h} := \text{Aff}_{\underbrace{\left[\frac{h}{2}, h, h, \dots, h, \frac{h}{2}\right]}_{n+1\text{-many}}, 0} \quad (8.2.2)$$

Lemma 8.2.4. Let $n \in \mathbb{N}$. Let $x_0 \in (-\infty, \infty)$, and $x_n \in [x_0, \infty)$. Let $x = [x_0, x_1, \dots, x_n] \in \mathbb{R}^{n+1}$ and $h \in (-\infty, \infty)$ such that for all $i \in \{0, 1, \dots, n\}$ it is the case that $x_i = x_0 + i \cdot h$. Then:

(i) for all $x \in \mathbb{R}^{n+1}$ it is the case that $(\mathcal{J}_\tau(\text{Etr}^{n,h}))(x) \in C(\mathbb{R}^{n+1}, \mathbb{R})$

(ii) for all $n \in \mathbb{N}$, and $h \in (0, \infty)$ it is the case that $(\mathcal{J}_\tau(\text{Etr}^{n,h}))(x) = \frac{h}{2} \cdot x_0 + h \cdot x_1 + \dots + h \cdot x_{n-1} + \frac{h}{2} \cdot x_n$

(iii) for all $n \in \mathbb{N}$, and $h \in (0, \infty)$ it is the case that $D(\text{Etr}^{n,h}) = 1$

(iv) for all $n \in \mathbb{N}$ and $h \in (0, \infty)$ it is the case that $P(\text{Etr}^{n,h}) = n + 2$

(v) for all $n \in \mathbb{N}$ and $h \in (0, \infty)$ it is the case that $L(\text{Etr}^{n,h}) = (n + 1, 1)$

Proof. This a straightforward consequence of Lemma 5.5.1. □

Remark 8.2.5. Let $h \in (0, \infty)$. Note then that Trp^h is simply $\text{Etr}^{2,h}$.

8.3 Linear Interpolation for Multi-Dimensional Functions

8.3.1 The Nrm_1^d Networks

Definition 8.3.1 (The Nrm_1^d neural network). We denote by $(\text{Nrm}_1^d)_{d \in \mathbb{N}} \subseteq \text{NN}$ the family of neural networks that satisfy:

(i) for $d = 1$:

$$\text{Nrm}_1^1 = \left(\left(\left(\begin{bmatrix} 1 \\ -1 \end{bmatrix}, \begin{bmatrix} 0 \\ 0 \end{bmatrix} \right), \left(\begin{bmatrix} 1 & 1 \\ & 1 \end{bmatrix}, \begin{bmatrix} 0 \end{bmatrix} \right) \right) \in (\mathbb{R}^{2 \times 1} \times \mathbb{R}^2) \times (\mathbb{R}^{1 \times 2} \times \mathbb{R}^1) \quad (8.3.1)$$

(ii) for $d \in \{2, 3, \dots\}$:

$$\text{Nrm}_1^d = \text{Sum}_{d,1} \bullet \left[\boxplus_{i=1}^d \text{Nrm}_1^1 \right] \quad (8.3.2)$$

Lemma 8.3.2. Let $d \in \mathbb{N}$. It is then the case that:

(i) $L(\text{Nrm}_1^d) = (d, 2d, 1)$

(ii) $(\mathfrak{J}_\tau(\text{Nrm}_1^d))(x) \in C(\mathbb{R}^d, \mathbb{R})$

(iii) that for all $x \in \mathbb{R}^d$ that $(\mathfrak{J}_\tau(\text{Nrm}_1^d))(x) = \|x\|_1$

(iv) it holds $H(\text{Nrm}_1^d) = 1$

(v) it holds that $P(\text{Nrm}_1^d) \leq 7d^2$

(vi) it holds that $D(\text{Nrm}_1^d) = 2$

Proof. Note that by observation, it is the case that $L(\text{Nrm}_1^d) = (1, 2, 1)$. This and Remark 5.5.2 tells us that for all $d \in \{2, 3, \dots\}$ it is the case that $L(\boxplus_{i=1}^d \text{Nrm}_1^d) = (d, 2d, d)$. This, Lemma 5.2.5, and Lemma 5.5.2 ensure that for all $d \in \{2, 3, 4, \dots\}$ it is the case that $L(\text{Nrm}_1^d) = (d, 2d, 1)$, which in turn establishes Item (i).

Notice now that (8.3.1) ensures that:

$$\left(\mathfrak{J}_\tau\left(\text{Nrm}_1^d\right)\right)(x) = \tau(x) + \tau(-x) = \max\{x, 0\} + \max\{-x, 0\} = |x| = \|x\|_1 \quad (8.3.3)$$

This along with (Grohs et al., 2023, Proposition 2.19) tells us that for all $d \in \{2, 3, 4, \dots\}$ and $x = (x_1, x_2, \dots, x_d) \in \mathbb{R}^d$ it is the case that:

$$\left(\mathfrak{J}_\tau\left[\boxplus_{i=1}^d \text{Nrm}_1^1\right]\right)(x) = (|x_1|, |x_2|, \dots, |x_d|) \quad (8.3.4)$$

This together with Lemma 5.2.3 tells us that:

$$\begin{aligned} \left(\mathfrak{J}_\tau\left(\text{Nrm}_1^d\right)\right) &= \left(\mathfrak{J}_\tau\left(\text{Sum}_{d,1} \bullet \left[\boxplus_{i=1}^d \text{Nrm}_1^1\right]\right)\right)(x) \\ &= \left(\mathfrak{J}_\tau(\text{Sum}_{d,1})\right)(|x_1|, |x_2|, \dots, |x_d|) = \sum_{i=1}^d |x_i| = \|x\|_1 \end{aligned} \quad (8.3.5)$$

Note next that by observation $H(\text{Nrm}_1^1) = 1$. Remark 5.5.2 then tells us that since the number of layers remains unchanged under stacking, it is then the case that $H(\text{Nrm}_1^d) = H(\boxplus_{i=1}^d \text{Nrm}_1^1) = 1$.

Note next that Lemma 5.2.4 then tells us that $H(\text{Sum}_{d,1}) = 0$ whence Lemma 5.2.5 tells us that:

$$\begin{aligned} H\left(\text{Nrm}_1^d\right) &= H\left(\text{Sum}_{d,1} \bullet \left[\boxplus_{i=1}^d \text{Nrm}_1^1\right]\right) \\ &= H(\text{Sum}_{d,1}) + H\left(\left[\boxplus_{i=1}^d \text{Nrm}_1^1\right]\right) = 0 + 1 = 1 \end{aligned} \quad (8.3.6)$$

Note next that:

$$\text{Nrm}_1^1 = \left(\left(\left(\begin{bmatrix} 1 \\ -1 \end{bmatrix}, \begin{bmatrix} 0 \\ 0 \end{bmatrix}\right), \left(\begin{bmatrix} 1 & 1 \\ 0 \end{bmatrix}\right)\right) \in (\mathbb{R}^{2 \times 1} \times \mathbb{R}^2) \times (\mathbb{R}^{1 \times 2} \times \mathbb{R}^1) \quad (8.3.7)$$

and as such $P(\text{Nrm}_1^1) = 7$. This, combined with Cor 5.3.5.1, and the fact that we are stacking

identical neural networks then tells us that:

$$P\left(\left[\Xi_{i=1}^d \text{Nrm}_1^1\right]\right) \leq 7d^2 \quad (8.3.8)$$

Then Lemma Corollary 5.5.5.1, Lemma 5.6.6, and Lemma 5.2.5 tells us that:

$$\begin{aligned} P\left(\text{Nrm}_1^d\right) &= P\left(\text{Sum}_{d,1} \bullet \left[\Xi_{i=1}^d \text{Nrm}_1^1\right]\right) \\ &\leq P\left(\left[\Xi_{i=1}^d \text{Nrm}_1^1\right]\right) \leq 7d^2 \end{aligned} \quad (8.3.9)$$

This establishes Item (v).

Finally, by observation $D(\text{Nrm}_1^1) = 2$, we are stacking the same neural network when we have Nrm_1^d . Stacking has no effect on depth from Definition 5.3.1, and by Lemma 5.2.5, $D(\text{Sum}_{d,1} \bullet [\Xi_{i=1}^d \text{Nrm}_1^1]) = D(\Xi \text{Nrm}_1^1)$. Thus we may conclude that $D(\text{Nrm}_1^d) = D(\text{Nrm}_1^1) = 2$.

This concludes the proof of the lemma. □

8.3.2 The Mxm^d Neural Networks

Given $x \in \mathbb{R}$, it is straightforward to find the maximum; x is the maximum. For $x \in \mathbb{R}^d$ we may find the maximum via network (8.3.8.1), i.e. Mxm^2 . The strategy is to find maxima for half our entries and half repeatedly until we have one maximum. For $x \in \mathbb{R}^d$ where d is even we may stack d copies of Mxm^2 to halve, and for $x \in \mathbb{R}^d$ where d is odd and greater than 3 we may introduce ``padding'' via the ld_1 network and thus require $\frac{d-1}{2}$ copies of Mxm^2 to halve.

Definition 8.3.3 (Maxima ANN representations). *Let $(\text{Mxm}^d)_{d \in \mathbb{N}} \subseteq \text{NN}$ represent the neural networks that satisfy:*

- (i) for all $d \in \mathbb{N}$ that $I(\text{Mxm}^d) = d$
- (ii) for all $d \in \mathbb{N}$ that $O(\text{Mxm}^d) = 1$
- (iii) that $\text{Mxm}^1 = \text{Aff}_{1,0} \in \mathbb{R}^{1 \times 1} \times \mathbb{R}^1$

(iv) that:

$$\text{Mxm}^2 = \left(\left(\left(\begin{bmatrix} 1 & -1 \\ 0 & 1 \\ 0 & -1 \end{bmatrix}, \begin{bmatrix} 0 \\ 0 \\ 0 \end{bmatrix} \right), \left(\begin{bmatrix} 1 & 1 & -1 \\ 0 \\ 0 \end{bmatrix} \right) \right) \right) \quad (8.3.10)$$

(v) it holds for all $d \in \{2, 3, \dots\}$ that $\text{Mxm}^{2d} = \text{Mxm}^d \bullet [\boxplus_{i=1}^d \text{Mxm}^2]$, and

(vi) it holds for all $d \in \{2, 3, \dots\}$ that $\text{Mxm}^{2d-1} = \text{Mxm}^d \bullet [(\boxplus_{i=1}^d \text{Mxm}^2) \boxminus \text{Id}_1]$.

Remark 8.3.4. Diagrammatically, this can be represented as:

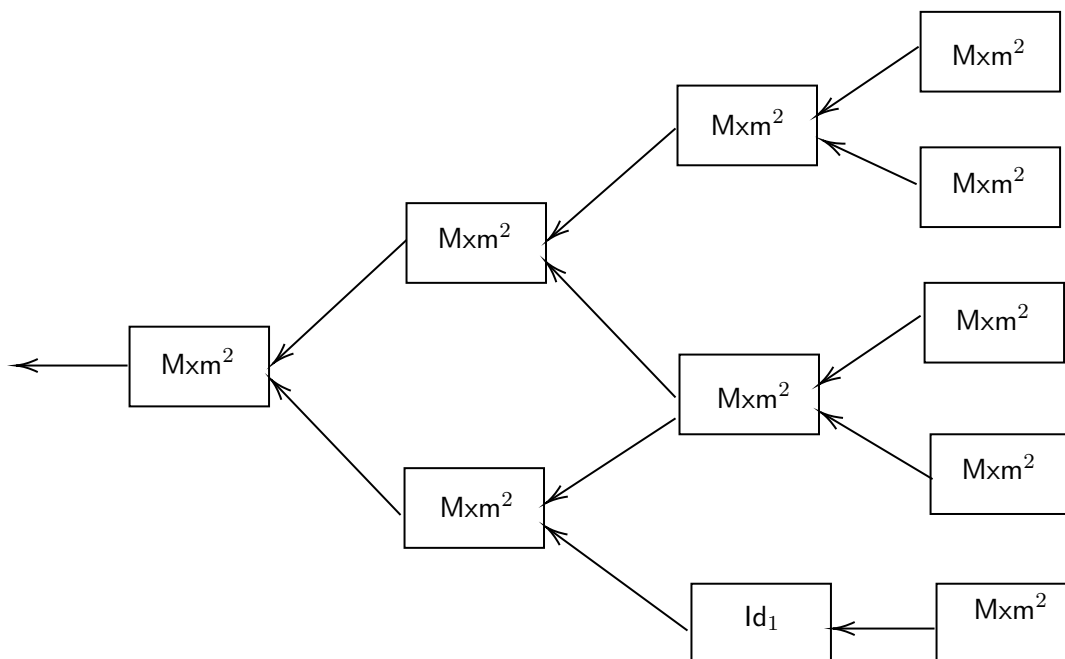

Figure 8.1: Neural network diagram for Mxm^5 .

Lemma 8.3.5. Let $d \in \mathbb{N}$, it is then the case that:

(i) $H(\text{Mxm}^d) = \lceil \log_2(d) \rceil$

(ii) for all $i \in \mathbb{N}$ that $W_i(\text{Mxm}^d) \leq 3 \lceil \frac{d}{2^i} \rceil$

(iii) $\mathcal{J}_r(\text{Mxm}^d) \in C(\mathbb{R}^d, \mathbb{R})$ and

(iv) for all $x = (x_1, x_2, \dots, x_d) \in \mathbb{R}^d$ we have that $(\mathcal{J}_r(\text{Mxm}^d))(x) = \max\{x_1, x_2, \dots, x_d\}$.

$$(v) \ P(\mathbf{Mxm}^d) \leq \left(\frac{4}{3}d^2 + 3d\right) \left(1 + \frac{1}{2}^{\lceil \log_2(d) \rceil + 1}\right)$$

$$(vi) \ D(\mathbf{Mxm}^d) = \lceil \log_2(d) \rceil + 1$$

Proof. Assume w.l.o.g. that $d > 1$. Note that (8.3.10) ensures that $H(\mathbf{Mxm}^d) = 1$. This and (5.3.1) then tell us that for all $d \in \{2, 3, 4, \dots\}$ it is the case that:

$$H\left(\bigoplus_{i=1}^d \mathbf{Mxm}^2\right) = H\left(\left[\bigoplus_{i=1}^d \mathbf{Mxm}^2\right] \oplus \text{Id}_1\right) = H(\mathbf{Mxm}^2) = 1$$

This and Lemma 5.2.5 tells us that for all $d \in \{3, 4, 5, \dots\}$ it holds that:

$$H(\mathbf{Mxm}^d) = H\left(\mathbf{Mxm}^{\lceil \frac{d}{2} \rceil}\right) + 1 \tag{8.3.11}$$

And for $d \in \{4, 6, 8, \dots\}$ with $H\left(\mathbf{Mxm}^{\lceil \frac{d}{2} \rceil}\right) = \lceil \log_2\left(\frac{d}{2}\right) \rceil$ it holds that:

$$H(\mathbf{Mxm}^d) = \left\lceil \log_2\left(\frac{d}{2}\right) \right\rceil + 1 = \lceil \log_2(d) - 1 \rceil + 1 = \lceil \log_2(d) \rceil \tag{8.3.12}$$

Moreover (8.3.11) and the fact that for all $d \in \{3, 5, 7, \dots\}$ it holds that $\lceil \log_2(d+1) \rceil = \lceil \log_2(d) \rceil$ ensures that for all $d \in \{3, 5, 7, \dots\}$ with $H\left(\mathbf{Mxm}^{\lceil \frac{d}{2} \rceil}\right) = \lceil \log_2\left(\lceil \frac{d}{2} \rceil\right) \rceil$ it holds that:

$$\begin{aligned} H(\mathbf{Mxm}^d) &= \left\lceil \log_2\left(\left\lceil \frac{d}{2} \right\rceil\right) \right\rceil + 1 = \left\lceil \log_2\left(\left\lceil \frac{d+1}{2} \right\rceil\right) \right\rceil + 1 \\ &= \lceil \log_2(d+1) - 1 \rceil + 1 = \lceil \log_2(d+1) \rceil = \lceil \log_2(d) \rceil \end{aligned} \tag{8.3.13}$$

This and (8.3.12) demonstrate that for all $d \in \{3, 4, 5, \dots\}$ with $\forall k \in \{2, 3, \dots, d-1\} : H(\mathbf{Mxm}^d) = \lceil \log_2(k) \rceil$ it holds that $H(\mathbf{Mxm}^d) = \lceil \log_2(d) \rceil$. The fact that $H(\mathbf{Mxm}^2) = 1$ and induction establish Item (i).

We next note that $L(\mathbf{Mxm}^2) = (2, 3, 1)$. This then indicates that for all $i \in \mathbb{N}$ that:

$$W_i(\mathbf{Mxm}^2) \leq 3 = 3 \left\lceil \frac{2}{2^i} \right\rceil. \tag{8.3.14}$$

Note then that Lemma 5.2.5 and Remark 5.5.2 tells us that:

$$W_i \left(\text{Mxm}^{2d} \right) = \begin{cases} 3d & : i = 1 \\ W_{i-1} \left(\text{Mxm}^d \right) & : i \geq 2 \end{cases} \quad (8.3.15)$$

And:

$$W_i \left(\text{Mxm}^{2d-1} \right) = \begin{cases} 3d - 1 & : i = 1 \\ W_{i-1} \left(\text{Mxm}^d \right) & : i \geq 2 \end{cases} \quad (8.3.16)$$

This in turn assures us that for all $d \in \{2, 4, 6, \dots\}$ it holds that:

$$W_1 \left(\text{Mxm}^d \right) = 3 \left(\frac{d}{2} \right) \leq 3 \left\lceil \frac{d}{2} \right\rceil \quad (8.3.17)$$

Moreover, note that (8.3.16) tells us that for all $d \in \{3, 5, 7, \dots\}$ it holds that:

$$W_1 \left(\text{Mxm}^d \right) = 3 \left\lceil \frac{d}{2} \right\rceil - 1 \leq 3 \left\lceil \frac{d}{2} \right\rceil \quad (8.3.18)$$

This and (8.3.17) shows that for all $d \in \{2, 3, \dots\}$ it holds that:

$$W_1 \left(\text{Mxm}^d \right) \leq 3 \left\lceil \frac{d}{2} \right\rceil \quad (8.3.19)$$

Additionally note that (8.3.15) demonstrates that for all $d \in \{4, 6, 8, \dots\}$, $i \in \{2, 3, \dots\}$ with $W_{i-1} \left(\text{Mxm}^{\frac{d}{2}} \right) \leq 3 \left\lceil \left(\frac{d}{2} \right) \frac{1}{2^{i-1}} \right\rceil$ it holds that:

$$W_i \left(\text{Mxm}^d \right) = W_{i-1} \left(\text{Mxm}^{\frac{d}{2}} \right) \leq 3 \left\lceil \left(\frac{d}{2} \right) \frac{1}{2^{i-1}} \right\rceil = 3 \left\lceil \frac{d}{2^i} \right\rceil \quad (8.3.20)$$

Furthermore note also the fact that for all $d \in \{3, 5, 7, \dots\}$, $i \in \mathbb{N}$ it holds that $\left\lceil \frac{d+1}{2^i} \right\rceil = \left\lceil \frac{d}{2^i} \right\rceil$ and (8.3.16) assure that for all $d \in \{3, 5, 7, \dots\}$, $i \in \{2, 3, \dots\}$ with $W_{i-1} \left(\text{Mxm}^{\left\lceil \frac{d}{2} \right\rceil} \right) \leq 3 \left\lceil \left\lceil \frac{d}{2} \right\rceil \frac{1}{2^{i-1}} \right\rceil$ it holds that:

$$W_i \left(\text{Mxm}^d \right) = W_{i-1} \left(\text{Mxm}^{\left\lceil \frac{d}{2} \right\rceil} \right) \leq 3 \left\lceil \left\lceil \frac{d}{2} \right\rceil \frac{1}{2^{i-1}} \right\rceil = 3 \left\lceil \frac{d+1}{2^i} \right\rceil = 3 \left\lceil \frac{d}{2^i} \right\rceil \quad (8.3.21)$$

This and (8.3.20) tells us that for all $d \in \{3, 4, \dots\}$, $i \in \{2, 3, \dots\}$ with $\forall k \in \{2, 3, \dots, d-1\}$, $j \in \{1, 2, \dots, i-1\} : W_j (\text{Mxm}^k) \leq 3 \lceil \frac{k}{2^i} \rceil$ it holds that:

$$W_i (\text{Mxm}^d) \leq 3 \left\lceil \frac{d}{2^i} \right\rceil \quad (8.3.22)$$

This, combined with (8.3.14), (8.3.19), with induction establishes Item (ii).

Next observe that (8.3.10) tells that for $x = \begin{bmatrix} x_1 \\ x_2 \end{bmatrix} \in \mathbb{R}^2$ it becomes the case that:

$$\begin{aligned} (\mathfrak{J}_\tau (\text{Mxm}^2)) (x) &= \max\{x_1 - x_2, 0\} + \max\{x_2, 0\} - \max\{-x_2, 0\} \\ &= \max\{x_1 - x_2, 0\} + x_2 = \max\{x_1, x_2\} \end{aligned} \quad (8.3.23)$$

Note next that Lemma 8.1.2, Lemma 5.2.5, and (Grohs et al., 2023, Proposition 2.19) then imply for all $d \in \{2, 3, 4, \dots\}$, $x = \{x_1, x_2, \dots, x_d\} \in \mathbb{R}^d$ it holds that $(\mathfrak{J}_\tau (\text{Mxm}^d)) (x) \in C(\mathbb{R}^d, \mathbb{R})$. and $(\mathfrak{J}_\tau (\text{Mxm}^d)) (x) = \max\{x_1, x_2, \dots, x_d\}$. This establishes Items (iii)-(iv).

Consider now the fact that Item (ii) implies that the layer architecture forms a geometric series whence we have that the number of bias parameters is bounded by:

$$\begin{aligned} \frac{\frac{3d}{2} \left(1 - \left(\frac{1}{2}\right)^{\lceil \log_2(d) \rceil + 1}\right)}{\frac{1}{2}} &= 3d \left(1 - \frac{1}{2}^{\lceil \log_2(d) \rceil + 1}\right) \\ &\leq \left\lceil 3d \left(1 - \frac{1}{2}^{\lceil \log_2(d) \rceil + 1}\right) \right\rceil \end{aligned} \quad (8.3.24)$$

For the weight parameters, consider the fact that our widths follow a geometric series with ratio $\frac{1}{2}$, and considering that we have an upper bound for the number of hidden layers, and the fact that

$W_0(M \times m^d) = d$, would then tell us that the number of weight parameters is bounded by:

$$\begin{aligned}
& \sum_{i=0}^{\lceil \log_2(d) \rceil} \left[\left(\frac{1}{2} \right)^i \cdot W_0(M \times m^d) \cdot \left(\frac{1}{2} \right)^{i+1} \cdot W_0(M \times m^d) \right] \\
&= \sum_{i=0}^{\lceil \log_2(d) \rceil} \left[\left(\frac{1}{2} \right)^{2i+1} \left(W_0(M \times m^d) \right)^2 \right] \\
&= \frac{1}{2} \sum_{i=0}^{\lceil \log_2(d) \rceil} \left[\left(\left(\frac{1}{2} \right)^i W_0(M \times m^d) \right)^2 \right] = \frac{1}{2} \sum_{i=0}^{\lceil \log_2(d) \rceil} \left[\left(\frac{1}{4} \right)^i d^2 \right] \tag{8.3.25}
\end{aligned}$$

Notice that this is a geometric series with ratio $\frac{1}{4}$, which would then reveal that:

$$\frac{1}{2} \sum_{i=0}^{\lceil \log_2(d) \rceil} \left[\left(\frac{1}{4} \right)^i d^2 \right] \leq \frac{2}{3} d^2 \left(1 - \frac{1}{2}^{2(\lceil \log_2(d) \rceil + 1)} \right) \tag{8.3.26}$$

Thus, we get that:

$$\begin{aligned}
P(M \times m^d) &\leq \frac{2}{3} d^2 \left(1 - \frac{1}{2}^{2(\lceil \log_2(d) \rceil + 1)} \right) + \left[3d \left(1 - \frac{1}{2}^{\lceil \log_2(d) \rceil + 1} \right) \right] \\
&\leq \frac{2}{3} d^2 \left(1 - \frac{1}{2}^{2(\lceil \log_2(d) \rceil + 1)} \right) + \left[3d \left(1 - \frac{1}{2}^{2(\lceil \log_2(d) \rceil + 1)} \right) \right] \tag{8.3.27}
\end{aligned}$$

$$\leq \left[\left(\frac{2}{3} d^2 + 3d \right) \left(1 + \frac{1}{2}^{2(\lceil \log_2(d) \rceil + 1)} \right) + 1 \right] \tag{8.3.28}$$

This proves Item (v).

Item (vi) is a straightforward consequence of Item (i). This completes the proof of the lemma. \square

8.3.3 The MC Neural Network and Approximations via Maximum Convolutions

Let $f : [a, b] \rightarrow \mathbb{R}$ be a continuous bounded function with Lipschitz constant L . Let $x_0 \leq x_1 \leq \dots \leq x_N$ be a set of sample points within $[a, b]$, with it being possibly the case that that for all $i \in \{0, 1, \dots, N\}$, $x_i \sim \text{Unif}([a, b])$. For all $i \in \{0, 1, \dots, N\}$, define a series of functions $f_0, f_1, \dots, f_N : [a, b] \rightarrow \mathbb{R}$, as such:

$$f_i = f(x_i) - L \cdot |x - x_i| \tag{8.3.29}$$

We will call the approximant $\max_{i \in \{0,1,\dots,N\}} \{f_i\}$, the *maximum convolution approximation*. This converges to f , as shown in

Lemma 8.3.6. *Let $d, N \in \mathbb{N}$, $L \in [0, \infty)$, $x_1, x_2, \dots, x_N \in \mathbb{R}^d$, $y = (y_1, y_2, \dots, y_N) \in \mathbb{R}^N$ and $\text{MC} \in \text{NN}$ satisfy that:*

$$\text{MC}_{x,y}^{N,d} = \text{Mxm}^N \bullet \text{Aff}_{-L\mathbb{I}_N, y} \bullet \left(\boxplus_{i=1}^N \left[\text{Nrm}_1^d \bullet \text{Aff}_{\mathbb{I}_d, -x_i} \right] \right) \bullet \text{Cpy}_{N,d} \quad (8.3.30)$$

It is then the case that:

(i) $\text{I}(\text{MC}) = d$

(ii) $\text{O}(\text{MC}) = 1$

(iii) $\text{H}(\text{MC}) = \lceil \log_2(N) \rceil + 1$

(iv) $\text{W}_1(\text{MC}) = 2dN$

(v) *for all $i \in \{2, 3, \dots\}$ we have $\text{W}_1(\text{MC}) \leq 3 \lceil \frac{N}{2^{i-1}} \rceil$*

(vi) *it holds for all $x \in \mathbb{R}^d$ that $(\mathcal{J}_r(\text{MC}))(x) = \max_{i \in \{1, 2, \dots, N\}} (y_i - L \|x - x_i\|_1)$*

(vii) *it holds that $\text{P}(\text{MC}) \leq \left[\left(\frac{2}{3}d^2 + 3d \right) \left(1 + \frac{1}{2}^{2(\lceil \log_2(d) \rceil + 1)} \right) + 1 \right] + 7N^2d^2 + 3 \lceil \frac{N}{2} \rceil \cdot 2dN$*

Proof. Throughout this proof let $S_i \in \text{NN}$ satisfy for all $i \in \{1, 2, \dots, N\}$ that $S_i = \text{Nrm}_1^d \bullet \text{Aff}_{\mathbb{I}_d, -x_i}$ and let $X \in \text{NN}$ satisfy:

$$X = \text{Aff}_{-L\mathbb{I}_N, y} \bullet \left(\boxplus_{i=1}^N S_i \right) \bullet \text{Cpy}_{N,d} \quad (8.3.31)$$

Note that (8.3.30) and Lemma 5.2.5 tells us that $\text{O}(\mathbb{R}) = \text{O}(\text{Mxm}^N) = 1$ and $\text{I}(\text{MC}) = \text{I}(\text{Cpy}_{N,d}) = d$. This proves Items (i)–(ii). Next observe that since it is the case that $\text{H}(\text{Cpy}_{N,d})$ and $\text{H}(\text{Nrm}_1^d) = 1$, Lemma 5.2.5 then tells us that:

$$\text{H}(X) = \text{H}(\text{Aff}_{-L\mathbb{I}_N, y}) + \text{H}(\boxplus_{i=1}^N S_i) + \text{H}(\text{Cpy}_{N,d}) = 1 \quad (8.3.32)$$

Thus Lemma 5.2.5 and Lemma 8.3.5 then tell us that:

$$H(\text{MC}) = H(\text{Mxm}^N \bullet \mathbf{X}) = H(\text{Mxm}^N) + H(\mathbf{X}) = \lceil \log_2(N) \rceil + 1 \quad (8.3.33)$$

Which in turn establishes Item (iii).

Note next that Lemma 5.2.5 and (Grohs et al., 2023, Proposition 2.20) tells us that:

$$W_1(\text{MC}) = W_1(\mathbf{X}) = W_1(\boxplus_{i=1}^N \mathbf{S}_i) = \sum_{i=1}^N W_1(\mathbf{S}_i) = \sum_{i=1}^N W_1(\text{Nrm}_1^d) = 2dN \quad (8.3.34)$$

This establishes Item (iv).

Next observe that the fact that $H(\mathbf{X}) = 1$, Lemma 5.2.5 and Lemma 8.3.5 tells us that for all $i \in \{2, 3, \dots\}$ it is the case that:

$$W_i(\text{MC}) = W_{i-1}(\text{Mxm}^N) \leq 3 \left\lceil \frac{N}{2^{i-1}} \right\rceil \quad (8.3.35)$$

This establishes Item (v).

Next observe that Lemma 8.3.2 and Lemma 5.5.5 tells us that for all $x \in \mathbb{R}^d$, $i \in \{1, 2, \dots, N\}$ it holds that:

$$(\mathfrak{J}_\tau(\text{MC}))(x) - \left(\mathfrak{J}_\tau(\text{Nrm}_1^d) \circ \mathfrak{J}_\tau(\text{Aff}_{\mathbb{I}_d, -x_i}) \right)(x) = \|x - x_i\|_1 \quad (8.3.36)$$

This an (Grohs et al., 2023, Proposition 2.20) combined establishes that for all $x \in \mathbb{R}^d$ it holds that:

$$(\mathfrak{J}_\tau(\boxplus_{i=1}^N \mathbf{S}_i) \bullet \text{Cpy}_{N,d})(x) = (\|x - x_1\|_1, \|x - x_2\|_1, \dots, \|x - x_N\|_1) \quad (8.3.37)$$

This and Lemma 5.5.5 establishes that for all $x \in \mathbb{R}^d$ it holds that:

$$\begin{aligned} (\mathfrak{J}_\tau(\mathbf{X}))(x) &= (\mathfrak{J}_\tau(\text{Aff}_{-L\mathbb{I}_N, y}) \circ (\mathfrak{J}_\tau(\boxplus_{i=1}^N \mathbf{S}_i) \bullet \text{Cpy}_{N,d}))(x) \\ &= (y_1 - L\|x - x_1\|, y_2 - L\|x - x_2\|, \dots, y_N - L\|x - x_N\|) \end{aligned} \quad (8.3.38)$$

Then Lemma 5.2.5 and Lemma 8.3.5 tells us that for all $x \in \mathbb{R}^d$ it holds that:

$$\begin{aligned}
(\mathfrak{J}_\tau(\text{MC}))(x) &= (\mathfrak{J}_\tau(\text{Mxm}^N) \circ (\mathfrak{J}_\tau(\text{X}))) (x) \\
&= (\mathfrak{J}_\tau(\text{Mxm}^N)) (y_1 - L\|x - x_1\|_1, y_2 - L\|x - x_2\|_1, \dots, y_N - L\|x - x_N\|_1) \\
&= \max_{i \in \{1, 2, \dots, N\}} (y_i - L\|x - x_i\|_1)
\end{aligned} \tag{8.3.39}$$

This establishes Item (vi).

For Item (vii) note that Lemma 8.3.2, Remark 5.3.4, Lemma 8.3.2, and Corollary 5.5.5.1 tells us that for all $d \in \mathbb{N}$ and $x \in \mathbb{R}^d$ it is the case that:

$$\mathbb{P} \left(\text{Nrm}_1^d \bullet \text{Aff}_{\mathbb{I}_d, -x} \right) \leq \mathbb{P} \left(\text{Nrm}_1^d \right) \leq 7d^2 \tag{8.3.40}$$

This, along with Corollary 5.3.5.1, and because we are stacking identical neural networks, then tells us that for all $N \in \mathbb{N}$, it is the case that:

$$\mathbb{P} \left(\boxminus_{i=1}^N \left[\text{Nrm}_1^d \bullet \text{Aff}_{\mathbb{I}_d, -x} \right] \right) \leq 7N^2 d^2 \tag{8.3.41}$$

Observe next that Corollary 5.5.5.1 tells us that for all $d, N \in \mathbb{N}$ and $x \in \mathbb{R}^d$ it is the case that:

$$\mathbb{P} \left(\left(\boxminus_{i=1}^N \left[\text{Nrm}_1^d \bullet \text{Aff}_{\mathbb{I}_d, -x} \right] \right) \bullet \text{Cpy}_{N,d} \right) \leq \mathbb{P} \left(\boxminus_{i=1}^N \left[\text{Nrm}_1^d \bullet \text{Aff}_{\mathbb{I}_d, -x} \right] \right) \leq 7N^2 d^2 \tag{8.3.42}$$

Now, let $d, N \in \mathbb{N}$, $L \in [0, \infty)$, let $x_1, x_2, \dots, x_N \in \mathbb{R}^d$ and let $y = \{y_1, y_2, \dots, y_N\} \in \mathbb{R}^N$. Observe that again, Corollary 5.5.5.1, and (8.3.42) tells us that:

$$\begin{aligned}
&\mathbb{P} \left(\text{Aff}_{-L\mathbb{I}_N, y} \bullet \left(\boxminus_{i=1}^N \left[\text{Nrm}_1^d \bullet \text{Aff}_{\mathbb{I}_d, -x_i} \right] \right) \bullet \text{Cpy}_{N,d} \right) \\
&\leq \mathbb{P} \left(\boxminus_{i=1}^N \left[\text{Nrm}_1^d \bullet \text{Aff}_{\mathbb{I}_d, -x} \right] \right) \leq 7N^2 d^2
\end{aligned}$$

Finally Lemma 5.2.5, (8.3.34), and Lemma 8.3.5 yields that:

$$\begin{aligned}
P(\text{MC}) &= P\left(\text{Mxm}^N \bullet \text{Aff}_{-L\mathbb{I}_N, y} \bullet \left(\boxplus_{i=1}^N \left[\text{Nrm}_1^d \bullet \text{Aff}_{\mathbb{I}_d, -x_i}\right]\right) \bullet \text{Cpy}_{N, d}\right) \\
&\leq P\left(\text{Mxm}^N \bullet \left(\boxplus_{i=1}^N \left[\text{Nrm}_1^d \bullet \text{Aff}_{\mathbb{I}_d, -x_i}\right]\right)\right) \\
&\leq P(\text{Mxm}^N) + P\left(\left(\boxplus_{i=1}^N \left[\text{Nrm}_1^d \bullet \text{Aff}_{\mathbb{I}_d, -x_i}\right]\right)\right) + \\
&W_1(\text{Mxm}^N) \cdot W_{\text{H}\left(\boxplus_{i=1}^N \left[\text{Nrm}_1^d \bullet \text{Aff}_{\mathbb{I}_d, -x_i}\right]\right)}\left(\boxplus_{i=1}^N \left[\text{Nrm}_1^d \bullet \text{Aff}_{\mathbb{I}_d, -x_i}\right]\right) \\
&\leq \left[\left(\frac{2}{3}d^2 + 3d\right) \left(1 + \frac{1}{2}^{2(\lceil \log_2(d) \rceil + 1)}\right) + 1\right] + 7N^2d^2 + 3 \left\lceil \frac{N}{2} \right\rceil \cdot 2dN \quad (8.3.43)
\end{aligned}$$

□

Remark 8.3.7. We may represent the neural network diagram for Mxm^d as:

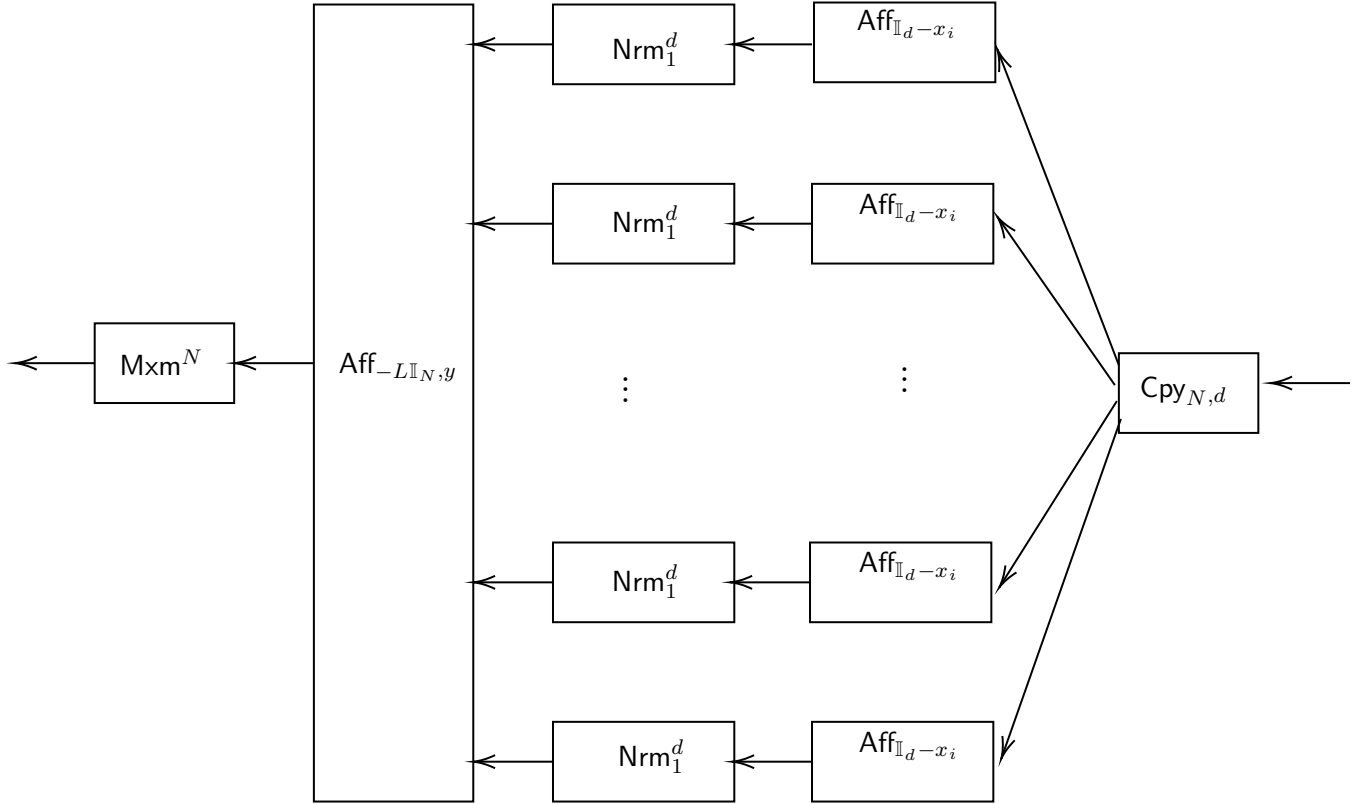

Figure 8.2: Neural network diagram for the Mxm network

8.3.4 Lipschitz Function Approximations

Lemma 8.3.8. *Let (E, d) be a metric space. Let $L \in [0, \infty)$, $D \subseteq E$, $\emptyset \neq C \subseteq D$. Let $f : D \rightarrow \mathbb{R}$ satisfy for all $x \in D$, $y \in C$ that $|f(x) - f(y)| \leq Ld(x, y)$, and let $F : E \rightarrow \mathbb{R} \cup \{\infty\}$ satisfy for all $x \in E$ that:*

$$F(x) = \sup_{y \in C} [f(y) - Ld(x, y)] \quad (8.3.44)$$

It is then the case that:

(i) *for all $x \in C$ that $F(x) = f(x)$*

(ii) *it holds for all $x \in D$, that $F(x) \leq f(x)$*

(iii) *it holds for all $x \in E$ that $F(x) < \infty$*

(iv) *it holds for all $x, y \in E$ that $|F(x) - F(y)| \leq Ld(x, y)$ and,*

(v) *it holds for all $x \in D$ that:*

$$|F(x) - f(x)| \leq 2L \left[\inf_{y \in C} d(x, y) \right] \quad (8.3.45)$$

Proof. The assumption that $\forall x \in D, y \in C : |f(x) - f(y)| \leq Ld(x, y)$ ensures that:

$$f(y) - Ld(x, y) \leq f(x) \leq f(y) + Ld(x, y) \quad (8.3.46)$$

For $x \in D$, it then renders as:

$$f(x) \geq \sup_{y \in C} [f(y) - Ld(x, y)] \quad (8.3.47)$$

This establishes Item (i). Note that (8.3.45) then tells us that for all $x \in C$ it holds that:

$$F(x) \geq f(x) - Ld(x, y) = f(x) \quad (8.3.48)$$

This with (8.3.47) then yields Item (i).

Note next that (8.3.46, with $x \curvearrowright y$ and $y \curvearrowright z$) and the triangle inequality ensure that for all $x \in E, y, z \in C$ it holds that:

$$f(y) - Ld(x, y) \leq f(z) + Ld(y, z) - Ld(x, y) \leq f(z) + Ld(x, z) \quad (8.3.49)$$

We then obtain for all $x \in E, z \in C$ it holds that:

$$F(x) = \sup_{y \in C} [f(y) - Ld(x, y)] \leq f(x) + Ld(x, z) < \infty \quad (8.3.50)$$

This proves Item (iii). Item (iii), (8.3.44), and the triangle inequality then shows that for all $x, y \in E$, it holds that:

$$\begin{aligned} F(x) - F(y) &= \left[\sup_{v \in C} (f(v) - Ld(x, v)) \right] - \left[\sup_{w \in C} (f(w) - Ld(y, w)) \right] \\ &= \sup_{v \in C} \left[f(v) - Ld(x, v) - \sup_{w \in C} (f(w) - Ld(y, w)) \right] \\ &\leq \sup_{v \in C} [f(v) - Ld(x, v) - (f(v) - Ld(y, w))] \\ &= \sup_{v \in C} (Ld(y, v) + Ld(x, v) - Ld(x, v)) = Ld(x, y) \end{aligned} \quad (8.3.51)$$

This establishes Item (v). Finally, note that Items (i) and (iv), the triangle inequality, and the assumption that $\forall x \in D, y \in C : |f(x) - f(y)| \leq Ld(x, y)$ ensure that for all $x \in D$ it holds that:

$$\begin{aligned} |F(x) - f(x)| &= \inf_{y \in C} |F(x) - F(y) + f(y) - f(x)| \\ &\leq \inf_{y \in C} (|F(x) - F(y)| + |f(y) - f(x)|) \\ &\leq \inf_{y \in C} (2Ld(x, y)) = 2L \left[\inf_{y \in C} d(x, y) \right] \end{aligned} \quad (8.3.52)$$

This establishes Item (v) and hence establishes the Lemma. □

Corollary 8.3.8.1. *Let (E, d) be a metric space, let $L \in [0, \infty)$, $\emptyset \neq C \subseteq E$, let $f : E \rightarrow \mathbb{R}$ satisfy for all $x \in E, y \in C$ that $|f(x) - f(y)| \leq Ld(x, y)$, and let $F : E \rightarrow \mathbb{R} \cup \{\infty\}$ satisfy for all $x \in E$*

that:

$$F(x) = \sup_{y \in C} [f(y) - Ld(x, y)] \quad (8.3.53)$$

It is then the case that:

(i) for all $x \in C$ that $F(x) = f(x)$

(ii) for all $x \in E$ that $F(x) \leq f(x)$

(iii) for all $x, y \in E$ that $|F(x) - f(y)| \leq Ld(x, y)$ and

(iv) for all $x \in E$ that:

$$|F(x) - f(x)| \leq 2L \left[\inf_{y \in C} d(x, y) \right] \quad (8.3.54)$$

Proof. Note that Lemma 8.3.4 establishes Items (i)—(iv). □

8.3.5 Explicit ANN Approximations

Lemma 8.3.9. Let $d, N \in \mathbb{N}$, $L \in [0, \infty)$. Let $E \subseteq \mathbb{R}^d$. Let $x_1, x_2, \dots, x_N \in E$, let $f : E \rightarrow \mathbb{R}$ satisfy for all $x_1, y_1 \in E$ that $|f(x_1) - f(y_1)| \leq L \|x_1 - x_2\|_1$ and let $\text{MC} \in \text{NN}$ and $y = (f(x_1), f(x_2), \dots, f(x_N))$ satisfy:

$$\text{MC} = \text{Mxm}^N \bullet \text{Aff}_{-L\mathbb{I}_N, y} \bullet \left[\boxplus_{i=1}^N \text{Nrm}_1^d \bullet \text{Aff}_{1_d, -x_i} \right] \bullet \text{Cpy}_{N, d} \quad (8.3.55)$$

It is then the case that:

$$\sup_{x \in E} |(\mathfrak{I}_\tau(\text{MC}))(x) - f(x)| \leq 2L \left[\sup_{x \in E} \left(\min_{i \in \{1, 2, \dots, N\}} \|x - x_i\|_1 \right) \right] \quad (8.3.56)$$

Proof. Throughout this proof let $F : \mathbb{R}^d \rightarrow \mathbb{R}$ satisfy that:

$$F(x) = \max_{i \in \{1, 2, \dots, N\}} (f(x_i) - L \|x - x_i\|_1) \quad (8.3.57)$$

Note then that Corollary 8.3.8.1, (8.3.57), and the assumption that for all $x, y \in E$ it holds that $|f(x) - f(y)| \leq L \|x - y\|_1$ assures that:

$$\sup_{x \in E} |F(x) - f(x)| \leq 2L \left[\sup_{x \in E} \left(\min_{i \in \{1, 2, \dots, N\}} \|x - x_i\|_1 \right) \right] \quad (8.3.58)$$

Then Lemma 8.3.6 tells us that for all $x \in E$ it holds that $F(x) = (\mathfrak{J}_\tau(\text{MC}))(x)$. This combined with (8.3.58) establishes (8.3.56). \square

Lemma 8.3.10. *Let $d, N \in \mathbb{N}$, $L \in [0, \infty)$. Let $E \subseteq \mathbb{R}^d$. Let $x_1, x_2, \dots, x_N \in E$, let $f : E \rightarrow \mathbb{R}$ satisfy for all $x_1, x_2 \in E$ that $|f(x_1) - f(x_2)| \leq L \|x_1 - x_2\|_1$ and let $\text{MC} \in \text{NN}$ and $y = (f(x_1), f(x_2), \dots, f(x_N))$ satisfy:*

$$\text{MC} = \text{Mxm}^N \bullet \text{Aff}_{-L\mathbb{I}_N, y} \bullet \left[\boxplus_{i=1}^N \text{Nrm}_1^d \bullet \text{Aff}_{\mathbb{I}_d, -x_i} \right] \bullet \text{Cpy}_{N, d} \quad (8.3.59)$$

It is then the case that:

$$\lim_{N \rightarrow \infty} \left[\mathbb{P} \left(\sup_{x \in E} |(\mathfrak{J}_\tau(\text{MC}))(x) - f(x)| > 0 \right) \right] \rightarrow 0 \quad (8.3.60)$$

Proof. Note that N is chosen uniformly from set $E \subseteq \mathbb{R}^d$. Note next that (8.3.58) tells us that:

$$\begin{aligned} & \lim_{N \rightarrow \infty} \left[\mathbb{P} \left(\sup_{x \in E} |(\mathfrak{J}_\tau(\text{MC}))(x) - f(x)| > 0 \right) \right] \\ & \leq \end{aligned} \quad (8.3.61)$$

\square

Part III

A deep-learning solution for u and Brownian motions

Chapter 9

ANN representations of Brownian Motion Monte Carlo

This is tentative without any reference to f .

Lemma 9.0.1 (R--,2023). *Let $d, M \in \mathbb{N}$, $T \in (0, \infty)$, $\mathfrak{a} \in C(\mathbb{R}, \mathbb{R})$, $\Gamma \in \mathbb{NN}$, satisfy that $\mathfrak{J}_{\mathfrak{a}}(\mathbf{G}_d) \in C(\mathbb{R}^d, \mathbb{R})$, for every $\theta \in \Theta$, let $\mathcal{U}^\theta : [0, T] \rightarrow [0, T]$ and $\mathcal{W}^\theta : [0, T] \rightarrow \mathbb{R}^d$ be functions, for every $\theta \in \Theta$, let $U^\theta : [0, T] \rightarrow \mathbb{R}^d \rightarrow \mathbb{R}$ satisfy satisfy for all $t \in [0, T]$, $x \in \mathbb{R}^d$ that:*

$$U^\theta(t, x) = \frac{1}{M} \left[\sum_{k=1}^M (\mathfrak{J}_{\mathfrak{a}}(\Gamma)) \left(x + \mathcal{W}^{\theta, 0, -k} \right) \right] \quad (9.0.1)$$

Let $\mathbf{U}_t^\theta \in \mathbb{NN}$, $\theta \in \Theta$ satisfy for all $\theta \in \Theta$, $t \in [0, T]$ that:

$$\mathbf{U}_t^\theta = \left[\bigoplus_{k=1}^M \left(\frac{1}{M} \triangleright \left(\mathbf{G}_d \bullet \text{Aff}_{\mathbb{I}_d, \mathcal{W}_{T-t}^{\theta, 0, -k}} \right) \right) \right] \quad (9.0.2)$$

It is then the case that:

(i) for all $\theta_1, \theta_2 \in \Theta$, $t_1, t_2 \in [0, T]$ that $\mathbf{L} \left(\mathbf{U}_{t_1}^{\theta_1} \right) = \mathbf{L} \left(\mathbf{U}_{t_2}^{\theta_2} \right)$.

(ii) for all $\theta \in \Theta$, $t \in [0, T]$, that $\mathbf{D} \left(\mathbf{U}_t^\theta \right) \leq \mathbf{D}(\mathbf{G}_d)$

(iii) for all $\theta \in \Theta$, $t \in [0, T]$ that:

$$\left\| \mathbf{L} \left(\mathbf{U}_t^\theta \right) \right\|_{\max} \leq \left\| \mathbf{L}(\mathbf{G}_d) \right\|_{\max} \left(1 + \sqrt{2} \right) M \quad (9.0.3)$$

(iv) for all $\theta \in \Theta$, $t \in [0, T]$, $x \in \mathbb{R}^d$ that $U^\theta(t, x) = (\mathfrak{J}_\alpha(\mathbf{U}_t^\theta))(x)$ and

(v) for all $\theta \in \Theta$, $t \in [0, T]$ that:

$$\mathbf{P}(\mathbf{U}_t^\theta) \leq 2D(\mathbf{G}_d) \left[(1 + \sqrt{2}) M \|\mathbf{L}(\mathbf{G}_d)\|_{\max} \right]^2 \quad (9.0.4)$$

Proof. Throughout the proof let $\mathbf{P}_t^\theta \in \mathbf{NN}$, $\theta \in \Theta$, $t \in [0, T]$ satisfy for all $\theta \in \Theta$, $t \in [0, T]$ that:

$$\mathbf{P}_t^\theta = \bigoplus_{k=1}^M \left[\frac{1}{M} \triangleright \left(\mathbf{G}_d \bullet \text{Aff}_{\mathbb{I}_d, \mathcal{W}_{T-t}^{\theta, 0, -k}} \right) \right] \quad (9.0.5)$$

Note the hypothesis that for all $\theta \in \Theta$, $t \in [0, T]$ it holds that $\mathcal{W}_t^\theta \in \mathbb{R}^d$ and Lemma 5.7.9 applied for every $\theta \in \Theta$, $t \in [0, T]$ with $v \curvearrowright M$, $c_{i \in \{u, u+1, \dots, v\}} \curvearrowright \left(\frac{1}{M}\right)_{i \in \{u, u+1, \dots, v\}}$, $(B_i)_{i \in \{u, u+1, \dots, v\}} \curvearrowright \left(\mathcal{W}_{T-t}^{\theta, 0, -k}\right)_{k \in \{1, 2, \dots, M\}}$, $(\nu_i)_{i \in \{u, u+1, \dots, v\}} \curvearrowright (\mathbf{G}_d)_{i \in \{u, u+1, \dots, v\}}$, $\mu \curvearrowright \Phi_t^\theta$ and with the notation of Lemma 5.7.9 tells us that for all $\theta \in \Theta$, $t \in [0, T]$, and $x \in \mathbb{R}^d$ it holds that: La lala

$$\mathbf{L}(\mathbf{P}_t^\theta) = (d, M \mathbf{W}_1(\mathbf{G}), M \mathbf{W}_2(\mathbf{G}), \dots, M \mathbf{W}_{D(\mathbf{G})-1}(\mathbf{G}), 1) = \mathbf{L}(\mathbf{P}_0^0) \in \mathbb{N}^{D(\mathbf{G})+1} \quad (9.0.6)$$

and that:

$$\begin{aligned} (\mathfrak{J}_\alpha(\mathbf{P}_t^\theta))(x) &= \frac{1}{M} \left[\sum_{k=1}^M (\mathfrak{J}_\alpha(\mathbf{G})) \left(x + \mathcal{W}_{T-t}^{\theta, 0, -k} \right) \right] \\ &= \mathbf{U}^\theta(t, x) \end{aligned} \quad (9.0.7)$$

This proves Item (i).

Note that (9.0.6), and (9.0.7) also implies that:

$$\begin{aligned} \mathbf{L}(\mathbf{U}_t^\theta) &= \mathbf{L}(\mathbf{P}_t^\theta) \\ &= (d, \mathbf{W}_1(\mathbf{P}_t^\theta), \mathbf{W}_2(\mathbf{P}_t^\theta), \dots, \mathbf{W}_{D(\mathbf{G})}(\mathbf{P}_t^\theta), t) \\ &= \mathbf{L}(\mathbf{U}_0^0) \in \mathbb{N}^{D(\mathbf{G})+1} \end{aligned} \quad (9.0.8)$$

This indicates that for all $\theta \in \Theta$, $t \in [0, T]$ it is the case that:

$$\begin{aligned} \left\| \mathbf{L} \left(\mathbf{U}_t^\theta \right) \right\|_\infty &= \left\| \mathbf{L} \left(\mathbf{U}_0^0 \right) \right\|_\infty \\ &= \max_{k \in \{1, 2, \dots, \mathbf{D}(\mathbf{G})\}} \left(\mathbf{W}_k \left(\mathbf{P}_0^0 \right) \right) \end{aligned}$$

This, (9.0.6), and Lemma 5.2.5 ensure that for all $\theta \in \Theta$, $t \in [0, T]$ it is the case that:

$$\begin{aligned} \left\| \mathbf{L} \left(\mathbf{U}_t^\theta \right) \right\|_\infty &= \left\| \mathbf{L} \left(\mathbf{U}_0^0 \right) \right\|_\infty \leq \left\| \mathbf{L} \left(\mathbf{P}_0^0 \right) \right\|_\infty \leq M \left\| \mathbf{L} \left(\mathbf{G} \right) \right\|_\infty \\ &\leq M \left\| \mathbf{L} \left(\mathbf{G} \right) \right\|_\infty + M \left[\left\| \mathbf{L} \left(\mathbf{U}_0^0 \right) \right\|_\infty \right] \end{aligned} \quad (9.0.9)$$

Then (Hutzenthaler et al., 2021, Corollary 4.3), with $\gamma \curvearrowright 0$, $\beta \curvearrowright M$, $k \curvearrowright 1$, $\alpha_0 \curvearrowright \left\| \mathbf{L} \left(\mathbf{G} \right) \right\|_\infty$, $\alpha_1 \curvearrowright 0$, $(x_i)_{i \in \{0, 1, \dots, k\}} \curvearrowright \left(\left\| \mathbf{L} \left(\mathbf{U}_0^0 \right) \right\|_\infty \right)_{i \in \{0, 1, \dots, n\}}$ in the notation of (Hutzenthaler et al., 2021, Corollary 4.3) yields for all $\theta \in \Theta$, $t \in [0, T]$ that:

$$\begin{aligned} \left\| \mathbf{L} \left(\mathbf{U}_t^\theta \right) \right\|_\infty &\leq \frac{1}{2} \left(\left\| \mathbf{L} \left(\mathbf{G} \right) \right\|_\infty \right) \left(1 + \sqrt{2} \right) M \\ &\leq \left(\left\| \mathbf{L} \left(\mathbf{G} \right) \right\|_\infty \right) \left(1 + \sqrt{2} \right) M \end{aligned}$$

Note that Lemma 5.2.5, Item (iii), proves that for all $\theta \in \Theta$, $t \in [0, T]$ it is the case that:

$$\mathbf{D} \left(\mathbf{U}_t^\theta \right) = \mathbf{D} \left(\mathbf{U}_0^0 \right) = \mathbf{D} \left(\mathbf{G} \right) \quad (9.0.10)$$

This proves Items (ii)--(iii) and (9.0.7) proves Item (iv).

Items (ii)--(iii) together shows that for all $\theta \in \Theta$, $t \in [0, T]$ it is the case that:

$$\begin{aligned} \mathbf{P} \left(\mathbf{U}_t^\theta \right) &\leq \sum_{k=1}^{\mathbf{D}(\mathbf{U}_t^\theta)} \left\| \mathbf{L} \left(\mathbf{U}_t^\theta \right) \right\|_{\max} \\ &= \mathbf{D} \left(\mathbf{U}_t^\theta \right) \left\| \mathbf{L} \left(\mathbf{U}_t^\theta \right) \right\|_\infty \\ &\leq \mathbf{D} \left(\mathbf{U}_t^\theta \right) \left(\left\| \mathbf{L} \left(\mathbf{G} \right) \right\|_\infty \right) \left(1 + \sqrt{2} \right) M \\ &= \mathbf{D} \left(\mathbf{G} \right) \left(\left\| \mathbf{L} \left(\mathbf{G} \right) \right\|_\infty \right) \left(1 + \sqrt{2} \right) M \end{aligned}$$

This proves Item (v) and hence the whole lemma. □

9.1 The $\mathbf{E}_n^{N,h,q,\varepsilon}$ Neural Network

Lemma 9.1.1 (R—, 2023). *Let $n, N \in \mathbb{N}$ and $h \in (0, \infty)$. Let $\delta, \varepsilon \in (0, \infty)$, $q \in (2, \infty)$, satisfy that $\delta = \varepsilon (2^{q-1} + 1)^{-1}$. Let $a \in (-\infty, \infty)$, $b \in [a, \infty)$. Let $f : [a, b] \rightarrow \mathbb{R}$ be continuous and have second derivatives almost everywhere in $[a, b]$. Let $a = x_0 \leq x_1 \leq \dots \leq x_{N-1} \leq x_N = b$ such that for all $i \in \{0, 1, \dots, N\}$ it is the case that $h = \frac{b-a}{N}$, and $x_i = x_0 + i \cdot h$. Let $x = [x_0 \ x_1 \ \dots \ x_N]$ and as such let $f \left([x]_{*,*} \right) = [f(x_0) \ f(x_1) \ \dots \ f(x_N)]$. Let $\mathbf{E}_n^{N,h,q,\varepsilon} \in \text{NN}$ be the neural network given by:*

$$\mathbf{E}_n^{N,h,q,\varepsilon} = \text{Xpr}_n^{q,\varepsilon} \bullet \text{Etr}^{N,h} \quad (9.1.1)$$

It is then the case that:

(i) for all $x \in \mathbb{R}^{N+1}$ we have that $(\mathfrak{J}_\tau (\mathbf{E}_n^{N,h,q,\varepsilon})) (x) \in C (\mathbb{R}^{N+1}, \mathbb{R})$

$$(ii) \ D (\mathbf{E}_n^{N,h,q,\varepsilon}) \leq \begin{cases} 1 & : n = 0 \\ n \left[\frac{q}{q-2} [\log_2 (\varepsilon^{-1}) + q] - 1 \right] + 1 & : n \geq 1 \end{cases}$$

(iii)

$$\begin{aligned} & \text{P} \left(\mathbf{E}_n^{N,h,q,\varepsilon} \right) \\ & \leq \begin{cases} N + 2 & : n = 0 \\ \left(\frac{1}{2}N + 1 \right) (n + 1) \left[4^{n+\frac{3}{2}} + \left(\frac{4^{n+1}-1}{3} \right) \left(\frac{360q}{q-2} [\log_2 (\varepsilon^{-1}) + q + 1] + 372 \right) \right] & : n \in \mathbb{N} \end{cases} \end{aligned}$$

(iv) for all $x = \{x_0, x_1, \dots, x_N\} \in \mathbb{R}^{N+1}$, where $a = x_0 \leq x_1 \leq \dots \leq x_{N-1} \leq x_N = b$ we have that:

$$\begin{aligned} & \left| \exp \left[\int_a^b f dx \right] - \mathfrak{J}_\tau \left(\mathbf{E}_n^{N,h,q,\varepsilon} \right) \left(f \left([x]_{*,*} \right) \right) \right| \\ & \leq \frac{(b-a)^3}{12N^2} f'' (\xi) \cdot n^2 \cdot \left[\Xi + \frac{(b-a)^3}{12N^2} f'' (\xi) \right]^{n-1} + \\ & \sum_{i=1}^n \frac{1}{i!} \left(|\Xi (\Xi^{i-1} - \mathfrak{J}_\tau (\text{Pwr}_{i-1}^{q,\varepsilon} (\Xi)))| + \varepsilon + |\Xi|^q + \mathfrak{p}_{i-1}^q \right) \end{aligned} \quad (9.1.2)$$

(v) it is the case that $\mathbf{W}_{\mathbf{H}(\mathbf{E}_n^{N,h,q,\varepsilon})} (\mathbf{E}_n^{N,h,q,\varepsilon}) \leq 24 + 2n$

Proof. Note that Lemma 8.2.4 tells us that $\mathfrak{J}_\tau(\text{Etr}^{N,h}) \in C(\mathbb{R}^{N+1}, \mathbb{R})$, and Lemma 6.2.22 tells us that $\mathfrak{J}_\tau(\text{Xpn}_n^{q,\varepsilon})(x) \in C(\mathbb{R}, \mathbb{R})$. Next, note that Lemma 5.2.5 and the fact that the composition of continuous functions is continuous yields that:

$$\begin{aligned}\mathfrak{J}_\tau\left(\mathbf{E}_n^{N,h,q,\varepsilon}\right) &= \mathfrak{J}_\tau\left(\text{Xpn}_n^{q,\varepsilon} \bullet \text{Aff}_{\left[\frac{h}{2}, h \dots h \frac{h}{2}\right], 0}\right) \\ &= \mathfrak{J}_\tau(\text{Xpn}_n^{q,\varepsilon}) \circ \mathfrak{J}_\tau\left(\text{Aff}_{\left[\frac{h}{2}, h \dots h \frac{h}{2}\right], 0}\right) \in C(\mathbb{R}^{N+1}, \mathbb{R})\end{aligned}$$

Since both component neural networks are continuous, and the composition of continuous functions is continuous, so is $\mathbf{E}_n^{N,h,q,\varepsilon}$. This proves Item (i).

Next note that $D\left(\text{Aff}_{\left[\frac{h}{2}, h \dots h \frac{h}{2}\right], 0}\right) = 1$, and thus Lemma 5.2.5 and Lemma 6.2.22 tells us that:

$$\begin{aligned}D\left(\mathbf{E}_n^{N,h,q,\varepsilon}\right) &= D\left(\text{Xpn}_n^{q,\varepsilon} \bullet \text{Aff}_{\left[\frac{h}{2}, h \dots h \frac{h}{2}\right], 0}\right) \\ &= D(\text{Xpn}_n^{q,\varepsilon}) + D\left(\text{Aff}_{\left[\frac{h}{2}, h \dots h \frac{h}{2}\right], 0}\right) - 1 \\ &= D(\text{Xpn}_n^{q,\varepsilon}) \\ &\leq \begin{cases} 1 & : n = 0 \\ n \left[\frac{q}{q-2} [\log_2(\varepsilon^{-1}) + q] - 1 \right] + 1 & : n \in \mathbb{N} \end{cases}\end{aligned}$$

This proves Item (ii).

Next note that by Corollary 5.5.5.1, Lemma 6.2.22, Lemma 8.2.4, and the fact that $l(\text{Etr}^{N,h}) = N + 1$, and $l(\text{Xpn}_n^{q,\varepsilon}) = 1$, tells us that, for all $N \in \mathbb{N}$ it is the case that:

$$\begin{aligned}P\left(\mathbf{E}_n^{N,h,q,\varepsilon}\right) &\leq \left[\max \left\{ 1, \frac{l(\text{Etr}^{N,h}) + 1}{l(\text{Xpn}_n^{q,\varepsilon}) + 1} \right\} \right] \cdot P(\text{Xpn}_n^{q,\varepsilon}) \\ &= \left(\frac{1}{2}N + 1 \right) \cdot P(\text{Xpn}_n^{q,\varepsilon}) \\ &\leq \begin{cases} N + 2 & : n = 0 \\ \left(\frac{1}{2}N + 1 \right) (n + 1) \left[4^{n+\frac{3}{2}} + \left(\frac{4^{n+1}-1}{3} \right) \left(\frac{360q}{q-2} [\log_2(\varepsilon^{-1}) + q + 1] + 372 \right) \right] & : n \in \mathbb{N} \end{cases}\end{aligned}$$

This proves Item (iii).

Note next that:

$$\text{Aff}_{[\frac{h}{2} \dots h \frac{h}{2}], 0} = \text{Etr}^{N, h} \quad (9.1.3)$$

Thus the well-known error term of the trapezoidal rule tells us that for $[a, b] \subsetneq \mathbb{R}$, and for $\xi \in [a, b]$ it is the case that:

$$\left| \int_a^b f(x) dx - \left(\mathfrak{J}_\tau \left(\text{Etr}^{N, h} \right) \right) \left(f \left([x]_{*,*} \right) \right) \right| \leq \frac{(b-a)^3}{12N^2} f''(\xi) \quad (9.1.4)$$

and for $n \in \mathbb{N}_0$, $\delta, \varepsilon \in (0, \infty)$, $q \in (2, \infty)$ and $\delta = \varepsilon(2^{q-1} + 1)^{-1}$, and for $x \in [\mathbf{a}, \mathbf{b}] \subsetneq \mathbb{R}$, with $0 \in [\mathbf{a}, \mathbf{b}]$ it is the case, according to Lemma 9.1.1, that:

$$|e^x - \mathfrak{J}_\tau(\text{Xpn}_n^{q, \varepsilon})(x)| \leq \sum_{i=1}^n \frac{1}{i!} (|x(x^{n-1} - \mathfrak{J}_\tau(\text{Pwr}_{n-1}^{q, \varepsilon})(x))| + \varepsilon + |x|^q + \mathfrak{p}_{n-1}^q) + \frac{e^b \cdot |x|^{n+1}}{(n+1)!} \quad (9.1.5)$$

Note now that for $f \in C_{ae}(\mathbb{R}, \mathbb{R})$, $\int_a^b f dx \in [\mathbf{a}, \mathbf{b}] \subsetneq \mathbb{R}$, $0 \in [\mathbf{a}, \mathbf{b}]$, and ξ between 0 and $\int_a^b f dx$ it is the case that:

$$\exp \left[\int_a^b f dx \right] = \sum_{i=1}^n \left[\frac{1}{i!} \left(\int_a^b f dx \right)^i \right] + \frac{e^\xi \cdot \left| \int_a^b f dx \right|^{n+1}}{(n+1)!} \quad (9.1.6)$$

And thus the triangle inequality, Lemma 5.2.5, and Lemma 6.2.22, tells us that for $x = \{x_0, x_1, \dots, x_N\}$, $a = x_0 \leq x_1 \leq \dots \leq x_N = b$ and $[a, b] \subsetneq \mathbb{R}$ that:

$$\begin{aligned} & \left| \exp \left[\int_a^b f dx \right] - \mathfrak{J}_\tau \left(\text{Etr}_n^{N, h, q, \varepsilon} \right) \left(f \left([x]_{*,*} \right) \right) \right| \\ &= \left| \sum_{i=1}^n \left[\frac{1}{i!} \left(\int_a^b f dx \right)^i \right] + \frac{e^\xi \cdot \left(\int_a^b f dx \right)^{n+1}}{(n+1)!} - \mathfrak{J}_\tau \left(\text{Xpn}_n^{q, \varepsilon} \bullet \text{Etr}^{N, h} \right) \left(f \left([x]_{*,*} \right) \right) \right| \\ &\leq \left| \sum_{i=1}^n \left[\frac{1}{i!} \left(\int_a^b f dx \right)^i \right] - \mathfrak{J}_\tau \left(\text{Xpn}_n^{q, \varepsilon} \right) (x) \circ \mathfrak{J}_\tau \left(\text{Etr}^{N, h} \right) \left(f \left([x]_{*,*} \right) \right) \right| + \frac{e^\xi \cdot \left| \int_a^b f dx \right|^{n+1}}{(n+1)!} \quad (9.1.7) \end{aligned}$$

Note that the instantiation of $\text{Etr}^{N, h}$ is exact as it is the instantiation of an affine neural network.

For notational simplicity let $\Xi = \mathfrak{J}_\tau (\text{Etr}^{N,h}) \left(f \left([x]_{*,*} \right) \right)$. Then Lemma 6.2.22 tells us that:

$$\left| \sum_{i=0}^n \left[\frac{\Xi^i}{i!} \right] - \mathfrak{J}_\tau (\text{Xpn}_n^{q,\varepsilon}) (\Xi) \right| \leq \sum_{i=1}^n \frac{1}{i!} \left(|\Xi (\Xi^{i-1} - \mathfrak{J}_\tau (\text{Pwr}_{i-1}^{q,\varepsilon}) (\Xi))| + \varepsilon + |\Xi|^q + (\mathfrak{p}_{i-1}^\Xi)^q \right) \quad (9.1.8)$$

Where for $i \in \mathbb{N}$, let \mathfrak{p}_{i-1}^Ξ be the family of functions defined as such:

$$\begin{aligned} \mathfrak{p}_1^\Xi &= \varepsilon + 1 + |\Xi|^2 \\ \mathfrak{p}_i^\Xi &= \varepsilon + (\mathfrak{p}_{i-1}^\Xi)^2 + |\Xi|^2 \end{aligned} \quad (9.1.9)$$

This then leaves us with:

$$\begin{aligned} \left| \sum_{i=0}^n \left[\frac{1}{i!} \left(\int_a^b f dx \right)^i \right] - \sum_{i=0}^n \left[\frac{\Xi^i}{i!} \right] \right| &\leq \sum_{i=0}^n \left| \left[\frac{1}{i!} \left(\int_a^b f dx \right)^i - \frac{\Xi^i}{i!} \right] \right| \\ &\leq (n+1) \max_{i \in \{0,1,\dots,n\}} \left| \left[\frac{1}{i!} \left(\int_a^b f dx \right)^i - \frac{\Xi^i}{i!} \right] \right| \\ &\leq n \cdot \max_{i \in \{1,\dots,n\}} \frac{1}{i!} \left| \left[\left(\int_a^b f dx \right)^i - \Xi^i \right] \right| \end{aligned} \quad (9.1.10)$$

Note that for each $i \in \{1, \dots, n\}$ it holds that:

$$\left(\int_a^b f dx \right)^i - \Xi^i = \left(\int_a^b f dx - \Xi \right) \left[\left(\int_a^b f dx \right)^{i-1} + \left(\int_a^b f dx \right)^{i-2} \cdot \Xi + \dots + \Xi^{i-1} \right] \quad (9.1.11)$$

Note that the well-known error bounds for the trapezoidal rule tell us that Ξ and $\int_a^b f dx$ differ by at most $\frac{(b-a)^3}{12N^2} f''(\xi)$ in absolute terms, and thus:

$$\max \left\{ \Xi, \int_a^b f dx \right\} \leq \Xi + \frac{(b-a)^3}{12N^2} f''(\xi) \quad (9.1.12)$$

This then renders (9.1.11) as:

$$\left(\int_a^b f dx \right)^i - \Xi^i \leq \frac{(b-a)^3}{12N^2} f''(\xi) \cdot i \cdot \left[\Xi + \frac{(b-a)^3}{12N^2} f''(\xi) \right]^{i-1} \quad (9.1.13)$$

Note that this also renders (9.1.10) as:

$$\left| \sum_{i=0}^n \left[\frac{1}{i!} \left(\int_a^b f dx \right)^i \right] - \sum_{i=0}^n \left[\frac{\Xi^i}{i!} \right] \right| \leq \frac{(b-a)^3}{12N^2} f''(\xi) \cdot n^2 \cdot \left[\Xi + \frac{(b-a)^3}{12N^2} f''(\xi) \right]^{n-1} \quad (9.1.14)$$

This, the triangle inequality and (9.1.8), then tell us for all $x \in [a, b] \subseteq [0, \infty)$ that:

$$\begin{aligned} & \left| \sum_{i=0}^n \left[\frac{1}{i!} \left(\int_a^b f dx \right)^i \right] - \mathfrak{J}_\tau(\mathbf{Xpn}_n^{q,\varepsilon})(x) \circ \Xi \right| \\ & \leq \left| \sum_{i=0}^n \left[\frac{1}{i!} \left(\int_a^b f dx \right)^i \right] - \sum_{i=0}^n \left[\frac{\Xi^i}{i!} \right] \right| + \left| \sum_{i=0}^n \left[\frac{\Xi^i}{i!} \right] - \mathfrak{J}_\tau(\mathbf{Xpn}_n^{q,\varepsilon})(x) \circ \Xi \right| \\ & \leq \frac{(b-a)^3}{12N^2} f''(\xi) \cdot n^2 \cdot \left[\Xi + \frac{(b-a)^3}{12N^2} f''(\xi) \right]^{n-1} + \\ & \quad \sum_{i=1}^n \frac{1}{i!} \left(|\Xi(\Xi^{i-1} - \mathfrak{J}_\tau(\mathbf{Pwr}_{i-1}^{q,\varepsilon})(\Xi))| + \varepsilon + |\Xi|^q + (\mathfrak{p}_{i-1}^\Xi)^q \right) \end{aligned} \quad (9.1.15)$$

This, applied to (9.1.7) then gives us that:

$$\begin{aligned} & \left| \exp \left[\int_a^b f dx \right] - \mathfrak{J}_\tau(\mathbf{E}_n^{N,h,q,\varepsilon})(f([x]_{*,*})) \right| \\ & \leq \left| \sum_{i=1}^n \left[\frac{1}{i!} \left(\int_a^b f dx \right)^i \right] - \mathfrak{J}_\tau(\mathbf{Xpn}_n^{q,\varepsilon})(x) \circ \mathfrak{J}_\tau(\mathbf{Etr}^{N,h})(f([x]_{*,*})) \right| + \frac{e^\xi \cdot \left| \int_a^b f dx \right|^{n+1}}{(n+1)!} \\ & \leq \frac{(b-a)^3}{12N^2} f''(\xi) \cdot n^2 \cdot \left[\Xi + \frac{(b-a)^3}{12N^2} f''(\xi) \right]^{n-1} + \\ & \quad \sum_{i=1}^n \frac{1}{i!} \left(|\Xi(\Xi^{i-1} - \mathfrak{J}_\tau(\mathbf{Pwr}_{i-1}^{q,\varepsilon})(\Xi))| + \varepsilon + |\Xi|^q + (\mathfrak{p}_{i-1}^\Xi)^q \right) + \frac{e^\xi \cdot \left| \int_a^b f dx \right|^{n+1}}{(n+1)!} \end{aligned} \quad (9.1.16)$$

This proves Item (iv).

Finally note that Lemma 6.2.22 tells us that:

$$\begin{aligned} W_{\mathbf{H}(\mathbf{E}_n^{N,h,q,\varepsilon})}(\mathbf{E}_n^{N,h,q,\varepsilon}) &= W_{\mathbf{H}(\mathbf{Xpn}_n^{q,\varepsilon})}(\mathbf{Xpn}_n^{q,\varepsilon}) \\ &\leq 24 + 2n \end{aligned} \quad (9.1.17)$$

□

Remark 9.1.2. We may represent the $E_n^{N,h,q,\varepsilon}$ diagrammatically as follows:

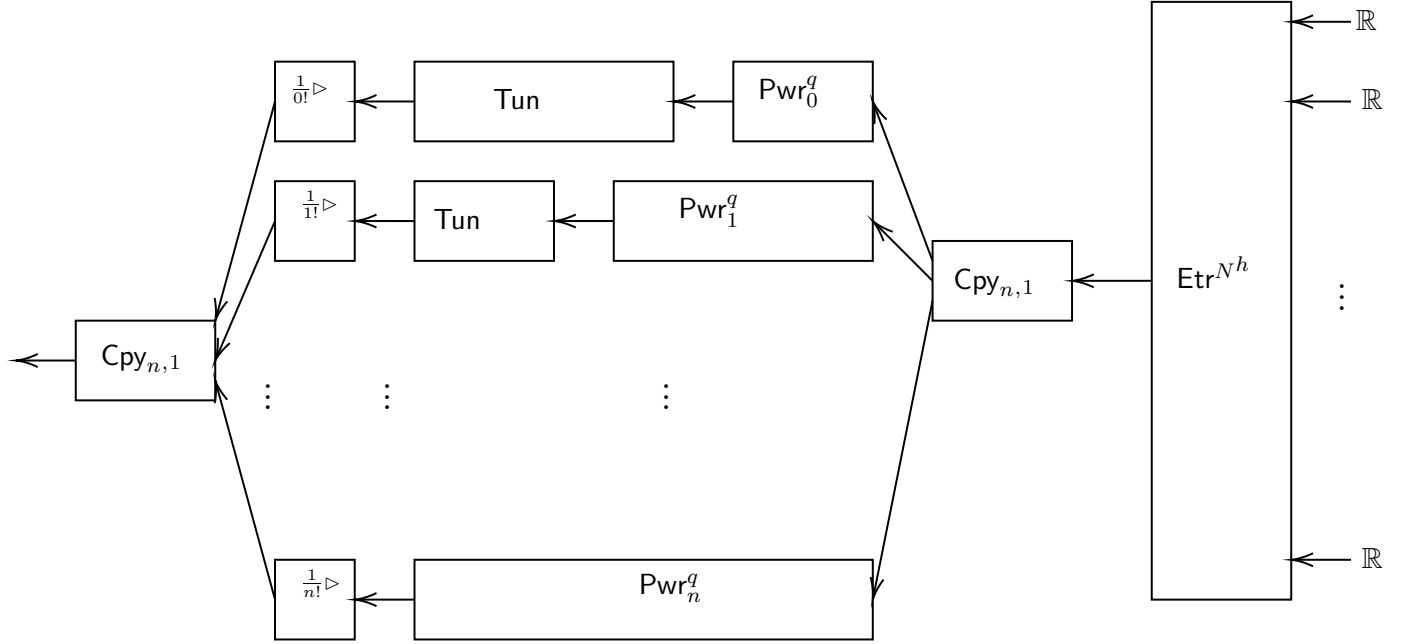

Figure 9.1: Diagram of $E_n^{N,h,q,\varepsilon}$.

9.2 The $UE_{n,G_d}^{N,h,q,\varepsilon}$ Neural Network

Lemma 9.2.1 (R—,2023). Let $n, N, h \in \mathbb{N}$. Let $\delta, \varepsilon \in (0, \infty)$, $q \in (2, \infty)$, satisfy that $\delta = \varepsilon(2^{q-1} + 1)^{-1}$. Let $a \in (-\infty, \infty)$, $b \in [a, \infty)$. Let $f : [a, b] \rightarrow \mathbb{R}$ be continuous and have second derivatives almost everywhere in $[a, b]$. Let $a = x_0 \leq x_1 \leq \dots \leq x_{N-1} \leq x_N = b$ such that for all $i \in \{0, 1, \dots, N\}$ it is the case that $h = \frac{b-a}{N}$, and $x_i = x_0 + i \cdot h$. Let $x = [x_0 \ x_1 \ \dots \ x_N]$ and as such let $f([x]_{*,*}) = [f(x_0) \ f(x_1) \ \dots \ f(x_N)]$. Let $E_{n,h,q,\varepsilon}^{\text{exp}} \in \text{NN}$ be the neural network given by:

$$E_n^{N,h,q,\varepsilon} = \text{Xpn}_n^{q,\varepsilon} \bullet \text{Etr}^{N,h} \quad (9.2.1)$$

Let $G_d \in \text{NN}$ be the neural network which instantiates as $\mathbf{u}_d = \mathfrak{J}_\tau(G_d)(x) \in C(\mathbb{R}^d, \mathbb{R})$ for all $x \in \mathbb{R}^d$.

Let $UE_{n,G_d}^{N,h,q,\varepsilon}$ be the neural network given as:

$$UE_{n,G_d}^{N,h,q,\varepsilon} = \text{Prd}^{q,\varepsilon} \bullet [E_n^{N,h,q,\varepsilon} \diamond G_d] \quad (9.2.2)$$

It is then the case that for all $\mathbf{x} = \{x_0, x_1, \dots, x_N\} \in \mathbb{R}^{N+1}$ and $x \in \mathbb{R}^d$ that:

$$(i) \mathfrak{J}_{\mathbf{r}} \left(\mathbf{UE}_{n, \mathbf{G}_d}^{N, h, q, \varepsilon} \right) (f([\mathbf{x}]_*) \frown x) \in C(\mathbb{R}^{N+1} \times \mathbb{R}^d, \mathbb{R})$$

$$(ii) \mathbf{D} \left(\mathbf{UE}_{n, \mathbf{G}_d}^{N, h, q, \varepsilon} \right) \leq \begin{cases} \frac{q}{q-2} [\log_2(\varepsilon^{-1}) + q] + \mathbf{D}(\mathbf{G}_d) - 1 & : n = 0 \\ \frac{q}{q-2} [\log_2(\varepsilon^{-1}) + q] + \max \left\{ \mathbf{D} \left(\mathbf{E}_{n, \mathbf{G}_d}^{N, h, q, \varepsilon} \right), \mathbf{D}(\mathbf{G}_d) \right\} - 1 & : n \geq 1 \end{cases}$$

(iii) It is also the case that:

$$\begin{aligned} \mathbf{P} \left(\mathbf{UE}_{n, \mathbf{G}_d}^{N, h, q, \varepsilon} \right) &\leq \frac{360q}{q-2} [\log_2(\varepsilon^{-1}) + q + 1] + 324 + 48n \\ &\quad + 24 \mathbf{W}_{\mathbf{H}(\mathbf{G}_d)}(\mathbf{G}_d) + 4 \max \left\{ \mathbf{P} \left(\mathbf{E}_{n, \mathbf{G}_d}^{N, h, q, \varepsilon} \right), \mathbf{P}(\mathbf{G}_d) \right\} \end{aligned} \quad (9.2.3)$$

(iv) It is also the case that:

$$\begin{aligned} &\left| \exp \left(\int_a^b f dx \right) \mathbf{u}_d(x) - \mathfrak{J}_{\mathbf{r}} \left(\mathbf{UE}_{n, \mathbf{G}_d}^{N, h, q, \varepsilon} \right) (f([\mathbf{x}]_*) \frown x) \right| \\ &\leq 3\varepsilon + 2\varepsilon |\mathbf{u}(x)|^q + 2\varepsilon \left| \exp \left(\int_a^b f dx \right) \right|^q + \varepsilon \left| \exp \left(\int_a^b f dx \right) - \mathbf{e} \right|^q - \mathbf{e} \mathbf{u}(x) \end{aligned}$$

Where, as per Lemma 9.1.1, \mathbf{e} is defined as:

$$\left| \mathbf{E}_n^{N, h, q, \varepsilon} (f([\mathbf{x}]_*)) - \exp \left(\int_a^b f dx \right) \right| \leq \mathbf{e} \quad (9.2.4)$$

Remark 9.2.2. Diagrammatically $\mathbf{UE}_n^{N, h, q, \varepsilon}$ can be represented as:

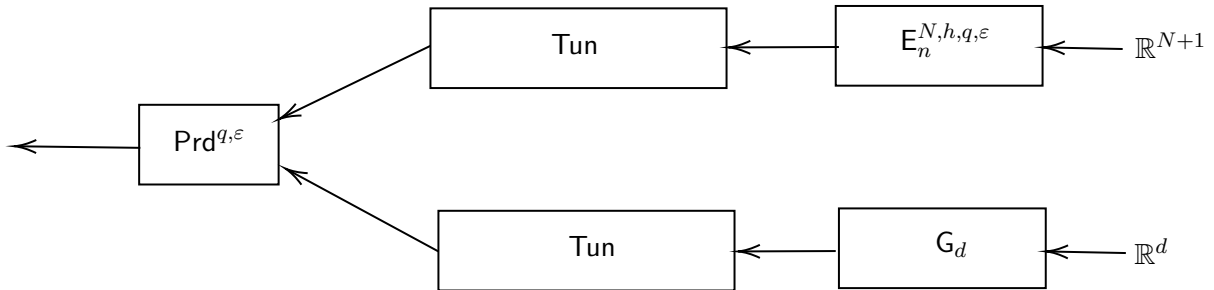

Proof. Note that from Lemma 5.2.5, and Lemma 5.3.3, we have that for $\mathbf{r} \in \mathbb{R}^{N+1}$, and $x \in \mathbb{R}^d$ it is the case that $\mathfrak{J}_{\mathbf{r}} \left(\mathbf{Prd}^{q, \varepsilon} \bullet \left[\mathbf{E}_n^{N, h, q, \varepsilon} \diamond \mathbf{G}_d \right] \right) (f([\mathbf{x}]_*) \frown x) = \mathfrak{J}_{\mathbf{r}} \left(\mathbf{Prd}^{q, \varepsilon} \right) \circ \mathfrak{J}_{\mathbf{r}} \left(\left[\mathbf{E}_n^{N, h, q, \varepsilon} \diamond \mathbf{G}_d \right] \right) (f([\mathbf{x}]_*) \frown x)$. Then Lemma 6.1.10 tells us that $\mathfrak{J}_{\mathbf{r}} \left(\mathbf{Prd}^{q, \varepsilon} \right) \in C(\mathbb{R}^2, \mathbb{R})$. Lemma 9.1.1 tells us that $\mathfrak{J}_{\mathbf{r}} \left(\mathbf{E}_n^{N, h, q, \varepsilon} \right) \in$

$C(\mathbb{R}^{N+1}, \mathbb{R})$ and by hypothesis it is the case that $\mathfrak{J}_\tau(\mathbf{G}_d) \in C(\mathbb{R}^d, \mathbb{R})$. Thus, by the stacking properties of continuous instantiated networks and the fact that the composition of continuous functions is continuous, we have that $\mathfrak{J}_\tau(\mathbf{UE}_{n, \mathbf{G}_d}^{N, h, q, \varepsilon}) \in C(\mathbb{R}^{N+1} \times \mathbb{R}^d, \mathbb{R})$.

Note that by Lemma 5.2.5 it is the case that:

$$D(\mathbf{UE}_{n, \mathbf{G}_d}^{N, h, q, \varepsilon}) = D(\text{Prd}^{q, \varepsilon}) + D(\mathbf{E}_n^{N, h, q, \varepsilon} \diamond \mathbf{G}_d) - 1 \quad (9.2.5)$$

Lemma 9.1.1 and Lemma 6.1.10 then tell us that:

$$D(\mathbf{UE}_{n, \mathbf{G}_d}^{N, h, q, \varepsilon}) \leq \begin{cases} \frac{q}{q-2} [\log_2(\varepsilon^{-1}) + q] + D(\mathbf{G}_d) - 1 & : n = 0 \\ \frac{q}{q-2} [\log_2(\varepsilon^{-1}) + q] + \max\{D(\mathbf{E}_n^{N, h, q, \varepsilon}), D(\mathbf{G}_d)\} - 1 & : n \geq 1 \end{cases} \quad (9.2.6)$$

Note that then Lemma 5.2.5, Lemma 6.2.22, and Lemma 9.1.1 tell us that:

$$\begin{aligned} P(\mathbf{UE}_{n, \mathbf{G}_d}^{N, h, q, \varepsilon}) &\leq P(\text{Prd}^{q, \varepsilon}) + 4 \max\{P(\mathbf{E}_n^{N, h, q, \varepsilon}), P(\mathbf{G}_d)\} \\ &\quad + W_1(\text{Prd}^{q, \varepsilon}) \cdot W_{\mathbf{H}(\mathbf{E}_n^{N, h, q, \varepsilon} \diamond \mathbf{G}_d)}(\mathbf{E}_n^{N, h, q, \varepsilon} \diamond \mathbf{G}_d) \\ &\leq P(\text{Prd}^{q, \varepsilon}) + 4 \max\{P(\mathbf{E}_n^{N, h, q, \varepsilon}), P(\mathbf{G}_d)\} \\ &\quad + 24[(24 + 2n) + W_{\mathbf{H}(\mathbf{G}_d)}(\mathbf{G}_d)] \\ &= P(\text{Prd}^{q, \varepsilon}) + 4 \max\{P(\mathbf{E}_n^{N, h, q, \varepsilon}), P(\mathbf{G}_d)\} \\ &\quad + 576 + 48n + 24 \cdot W_{\mathbf{H}(\mathbf{G}_d)}(\mathbf{G}_d) \\ &\leq \frac{360q}{q-2} [\log_2(\varepsilon^{-1}) + q + 1] + 324 + 48n \\ &\quad + 24 W_{\mathbf{H}(\mathbf{G}_d)}(\mathbf{G}_d) + 4 \max\{P(\mathbf{E}_n^{N, h, q, \varepsilon}), P(\mathbf{G}_d)\} \end{aligned} \quad (9.2.7)$$

Now note that Lemma 5.2.5, and Lemma 5.3.3 tells us that for all $\mathfrak{r} = \{x_1, x_2, \dots, x_n\} \in \mathbb{R}^n$ and $x \in \mathbb{R}^d$:

$$\mathfrak{J}_\tau(\text{Prd}^{q, \varepsilon} \bullet [\mathbf{E}_n^{N, h, q, \varepsilon} \diamond \mathbf{G}_d])(f([\mathfrak{r}]_* \frown x)) = \mathfrak{J}_\tau(\text{Prd}^{q, \varepsilon})(\mathfrak{J}_\tau(\mathbf{E}_n^{N, h, q, \varepsilon}), \mathfrak{J}_\tau(\mathbf{G}_d))(f([\mathfrak{r}]_* \frown x)). \quad (9.2.8)$$

Note then that the triangle inequality tells us that:

$$\begin{aligned}
& \left| \exp \left(\int_a^b f dx \right) \mathbf{u}_d(x) - \mathfrak{J}_\tau \left(\mathbf{U} \mathbf{E}_{n, \mathbf{G}_d}^{N, h, q, \varepsilon} \right) (f([\mathfrak{x}]_*) \frown x) \right| \\
&= \left| \exp \left(\int_a^b f dx \right) \cdot \mathbf{u}_d(x) - \mathfrak{J}_\tau (\text{Prd}^{q, \varepsilon}) \left(\mathfrak{J}_\tau \left(\mathbf{E}_n^{N, h, q, \varepsilon} \right), \mathfrak{J}_\tau (\mathbf{G}_d) \right) (f([\mathfrak{x}]_*) \frown x) \right| \\
&\leq \left| \exp \left(\int_a^b f dx \right) \cdot \mathbf{u}_d(x) - \mathfrak{J}_\tau (\text{Prd}^{q, \varepsilon}) \left(\exp \left(\int_a^b f dx \right), \mathbf{u}_d(x) \right) \right| \\
&+ \left| \mathfrak{J}_\tau (\text{Prd}^{q, \varepsilon}) \left(\exp \left(\int_a^b f dx \right), \mathbf{u}_d(x) \right) - \mathfrak{J}_\tau (\text{Prd}^{q, \varepsilon}) \left(\mathfrak{J}_\tau \left(\mathbf{E}_n^{N, h, q, \varepsilon} \right), \mathfrak{J}_\tau (\mathbf{G}_d) \right) (f([\mathfrak{x}]) \frown x) \right| \quad (9.2.9)
\end{aligned}$$

Note that Lemma 6.1.10 bounds the first summand. Note that by hypothesis $\mathfrak{J}_\tau(\mathbf{G}_d)$ is exactly $\mathbf{u}_d(x)$. Note also that by Lemma 9.1.1, Lemma 6.1.10, we realize that the second summand can be bounded as such:

$$\begin{aligned}
& \left| \mathfrak{J}_\tau (\text{Prd}^{q, \varepsilon}) \left(\exp \left(\int_a^b f dx \right), \mathbf{u}_d(x) \right) - \mathfrak{J}_\tau (\text{Prd}^{q, \varepsilon}) \left(\mathfrak{J}_\tau \left(\mathbf{E}_n^{N, h, q, \varepsilon} \right), \mathfrak{J}_\tau (\mathbf{G}_d) \right) (f([\mathfrak{x}]_*) \frown x) \right| \\
&\leq \exp \left(\int_a^b f dx \right) \mathbf{u}_d(x) + \varepsilon + \varepsilon \left| \exp \left(\int_a^b f dx \right) \right|^q + \varepsilon |\mathbf{u}_d(x)|^q \\
&- \left[\mathfrak{J}_\tau \left(\mathbf{E}_n^{N, h, q, \varepsilon} \right) (f([\mathfrak{x}]_*)) \mathfrak{J}_\tau (\mathbf{G}_d)(x) - \varepsilon - \varepsilon \left| \mathfrak{J}_\tau \left(\mathbf{E}_n^{N, h, q, \varepsilon} \right) (f([\mathfrak{x}]_*)) \right|^q - \varepsilon |\mathfrak{J}_\tau (\mathbf{G}_d)(x)|^q \right] \quad (9.2.10)
\end{aligned}$$

Per Lemma 9.1.1, let ϵ represent the error in approximation of $\mathbf{E}_n^{N, h, q, \varepsilon}$, that is to say for all $\mathfrak{x} \in \mathbb{R}^{N+1}$ and corresponding $f([\mathfrak{x}]_*)$, let it be the case that:

$$\left| \mathbf{E}_n^{N, h, q, \varepsilon} (f([\mathfrak{x}]_*)) - \exp \left(\int_a^b f dx \right) \right| \leq \epsilon \quad (9.2.11)$$

Thus $\mathbf{E}_n^{N, h, q, \varepsilon} (f([\mathfrak{x}]_*))$ is maximally $\epsilon + \exp \left(\int_a^b f dx \right)$ and minimally $\exp \left(\int_a^b f dx \right) - \epsilon$. Thus (9.2.10)

is rendered as:

$$\begin{aligned}
& \exp\left(\int_a^b f dx\right) \mathbf{u}_d(x) + \varepsilon + \varepsilon \left| \exp\left(\int_a^b f dx\right) \right|^q + \varepsilon |\mathbf{u}_d(x)|^q \\
& - \left[\mathfrak{J}_\tau\left(\mathbf{E}_n^{N,h,q,\varepsilon}\right) \mathfrak{J}_\tau\left(\mathbf{G}_d\right)\left(f\left([\mathbf{x}]_*\right) \frown x\right) - \varepsilon - \varepsilon \left| \mathfrak{J}_\tau\left(\mathbf{E}_n^{N,h,q,\varepsilon}\right)\left(f\left([\mathbf{x}]_*\right)\right) \right|^q - \varepsilon \left| \mathfrak{J}_\tau\left(\mathbf{G}_d\right)(x) \right|^q \right] \\
& \leq \exp\left(\int_a^b f dx\right) \mathbf{u}_d(x) + \varepsilon + \varepsilon \left| \exp\left(\int_a^b f dx\right) \right|^q + \varepsilon |\mathbf{u}_d(x)|^q \\
& - \left[\left(\mathbf{e} + \exp\left(\int_a^b f dx\right)\right) \mathbf{u}_d(x) - \varepsilon - \varepsilon \left| \exp\left(\int_a^b f dx\right) - \mathbf{e} \right|^q - \varepsilon |\mathbf{u}_d(x)|^q \right] \\
& = \cancel{\exp\left(\int_a^b f dx\right) \mathbf{u}_d(x)} + \varepsilon + \varepsilon \left| \exp\left(\int_a^b f dx\right) \right|^q + \varepsilon |\mathbf{u}_d(x)|^q \\
& - \mathbf{e} \mathbf{u}_d(x) - \cancel{\exp\left(\int_a^b f dx\right) \mathbf{u}_d(x)} + \varepsilon + \varepsilon \left| \exp\left(\int_a^b f dx\right) - \mathbf{e} \right|^q + \varepsilon |\mathbf{u}_d(x)|^q \\
& = 2\varepsilon + 2\varepsilon |\mathbf{u}_d(x)|^q + \varepsilon \left| \exp\left(\int_a^b f dx\right) - \mathbf{e} \right|^q + \varepsilon \left| \exp\left(\int_a^b f dx\right) \right|^q - \mathbf{e} \mathbf{u}_d(x) \tag{9.2.12}
\end{aligned}$$

This, together with (9.2.9), then tells us that:

$$\begin{aligned}
& \left| \exp\left(\int_a^b f dx\right) \mathbf{u}_d(x) - \mathfrak{J}_\tau\left(\mathbf{UE}_{n,\mathbf{G}_d}^{N,h,q,\varepsilon}\right)\left(f\left([\mathbf{x}]_*\right) \frown x\right) \right| \\
& \leq \left| \exp\left(\int_a^b f dx\right) \mathbf{u}_d(x) - \mathfrak{J}_\tau\left(\text{Prd}^{q,\varepsilon}\right)\left(\exp\left(\int_a^b f dx\right), \mathbf{u}_d(x)\right) \right| \\
& + \left| \mathfrak{J}_\tau\left(\text{Prd}^{q,\varepsilon}\right)\left(\exp\left(\int_a^b f dx\right), \mathbf{u}_d(x)\right) - \mathfrak{J}_\tau\left(\text{Prd}^{q,\varepsilon}\right)\left(\mathfrak{J}_\tau\left(\mathbf{E}_n^{N,h,q,\varepsilon}\right)\left(f\left([\mathbf{x}]_*\right)\right), \mathfrak{J}_\tau\left(\mathbf{G}_d\right)(x)\right) \right| \\
& \leq \varepsilon + \varepsilon \left| \exp\left(\int_a^b f dx\right) \right|^q + \varepsilon |\mathbf{u}_d(x)|^q \\
& + 2\varepsilon + 2\varepsilon |\mathbf{u}_d(x)|^q + \varepsilon \left| \exp\left(\int_a^b f dx\right) - \mathbf{e} \right|^q + \varepsilon \left| \exp\left(\int_a^b f dx\right) \right|^q - \mathbf{e} \mathbf{u}_d(x) \\
& = 3\varepsilon + 2\varepsilon |\mathbf{u}_d(x)|^q + 2\varepsilon \left| \exp\left(\int_a^b f dx\right) \right|^q + \varepsilon \left| \exp\left(\int_a^b f dx\right) - \mathbf{e} \right|^q - \mathbf{e} \mathbf{u}_d(x)
\end{aligned}$$

□

9.3 The $\text{UEX}_{n,\mathbf{G}_d,\omega_i}^{N,h,q,\varepsilon}$ network

Lemma 9.3.1 (R—,2023). *Let $n, N, h \in \mathbb{N}$. Let $\delta, \varepsilon \in (0, \infty)$, $q \in (2, \infty)$, satisfy that $\delta = \varepsilon(2^{q-1} + 1)^{-1}$. Let $a \in (-\infty, \infty)$, $b \in [a, \infty)$. Let $f : [a, b] \rightarrow \mathbb{R}$ be continuous and have second derivatives almost everywhere in $[a, b]$. Let $a = x_0 \leq x_1 \leq \dots \leq x_{N-1} \leq x_N = b$ such that for all*

$i \in \{0, 1, \dots, N\}$ it is the case that $h = \frac{b-a}{N}$, and $x_i = x_0 + i \cdot h$. Let $x = [x_0 \ x_1 \ \dots \ x_N]$ and as such let $f([x]_{*,*}) = [f(x_0) \ f(x_1) \ \dots \ f(x_N)]$. Let $\mathbf{E}_{n,h,q,\varepsilon}^{\text{exp}} \in \text{NN}$ be the neural network given by:

$$\mathbf{E}_n^{N,h,q,\varepsilon} = \text{Xpr}_n^{q,\varepsilon} \bullet \text{Etr}^{N,h} \quad (9.3.1)$$

Let $\mathbf{G}_d \subsetneq \text{NN}$ be the neural networks which, for $d \in \mathbb{N}$, instantiate as $\mathbf{u}_d = \mathfrak{J}_\tau(\mathbf{G}_d)(x) \in C(\mathbb{R}^d, \mathbb{R})$ for all $x \in \mathbb{R}^d$.

Let $\text{UE}_{n,\mathbf{G}_d}^{N,h,q,\varepsilon} \subsetneq \text{NN}$ be the neural networks given as:

$$\text{UE}_{n,\mathbf{G}_d}^{N,h,q,\varepsilon} = \text{Prd}^{q,\varepsilon} \bullet \left[\mathbf{E}_n^{N,h,q,\varepsilon} \diamond \mathbf{G}_d \right] \quad (9.3.2)$$

Finally let $\text{UEX}_{n,\mathbf{G}_d,\omega_i}^{N,h,q,\varepsilon} \subsetneq \text{NN}$ be given the neural networks given by:

$$\text{UEX}_{n,\mathbf{G}_d,\omega_i}^{N,h,q,\varepsilon} = \text{UE}_{n,\mathbf{G}_d}^{N,h,q,\varepsilon} \bullet \left[\text{Tun}_1^{N+1} \boxplus \text{Aff}_{0,d,\mathcal{X}_{\omega_i}} \right] \quad (9.3.3)$$

It is then the case that for all $\mathbf{x} = \{x_0, x_1, \dots, x_N\} \in \mathbb{R}^{N+1}$ and $x \in \mathbb{R}^d$ that:

(i) $\mathfrak{J}_\tau \left(\text{UEX}_{n,\mathbf{G}_d,\omega_i}^{N,h,q,\varepsilon} \right) \in C(\mathbb{R}^{N+1} \times \mathbb{R}^d, \mathbb{R})$

(ii)

$$\begin{aligned} \text{D} \left(\text{UEX}_{n,\mathbf{G}_d,\omega_i}^{N,h,q,\varepsilon} \right) &= \text{D} \left(\text{UE}_{n,\mathbf{G}_d}^{N,h,q,\varepsilon} \right) \\ &\leq \begin{cases} \frac{q}{q-2} [\log_2(\varepsilon^{-1}) + q] + \text{D}(\mathbf{G}_d) - 1 & : n = 0 \\ \frac{q}{q-2} [\log_2(\varepsilon^{-1}) + q] + \max \left\{ \text{D} \left(\mathbf{E}_{N,n,h,q,\varepsilon}^{\text{exp},f} \right), \text{D}(\mathbf{G}_d) \right\} - 1 & : n \in \mathbb{N} \end{cases} \end{aligned}$$

(iii) It is also the case that:

$$\begin{aligned} \text{P} \left(\text{UEX}_{n,\mathbf{G}_d,\omega_i}^{N,h,q,\varepsilon} \right) &= \text{P} \left(\text{UE}_{n,\mathbf{G}_d}^{N,h,q,\varepsilon} \right) \leq \frac{360q}{q-2} [\log_2(\varepsilon^{-1}) + q + 1] + 324 + 48n \\ &\quad + 24 \text{W}_{\text{H}(\mathbf{G}_d)}(\mathbf{G}_d) + 4 \max \left\{ \text{P} \left(\mathbf{E}_n^{N,h,q,\varepsilon} \right), \text{P}(\mathbf{G}_d) \right\} \quad (9.3.4) \end{aligned}$$

(iv) It is also the case that:

$$\begin{aligned} & \left| \exp \left(\int_t^T f ds \right) \mathbf{u}_d^T(x) - \mathfrak{J}_\tau \left(\text{UEX}_{n, \mathcal{G}_d, \omega_i}^{N, h, q, \varepsilon} \right) (f([\mathbf{x}]_*) \curvearrowright x) \right| \\ & \leq 3\varepsilon + 2\varepsilon \left| \mathbf{u}_d^T(t, x) \right|^q + 2\varepsilon \left| \exp \left(\int_a^b f dx \right) \right|^q + \varepsilon \left| \exp \left(\int_a^b f dx \right) - \mathbf{e} \right|^q - \mathbf{e} \mathbf{u}_d^T(x) \end{aligned}$$

Where, as per Lemma 9.1.1, \mathbf{e} is defined as:

$$\left| \mathbf{E}_n^{N, h, q, \varepsilon} (f([\mathbf{x}]_*)) - \exp \left(\int_a^b f dx \right) \right| \leq \mathbf{e} \quad (9.3.5)$$

Proof. Note that (9.4.8) is an assertion of Feynman-Kac. LetNow notice that for $x \in \mathbb{R}^{N+1} \times \mathbb{R}^d$ it is the case that:

$$\begin{aligned} \mathfrak{J}_\tau \left(\text{UEX}_{n, \mathcal{G}_d, \omega_i}^{N, h, q, \varepsilon} \right) (x) &= \mathfrak{J}_\tau \left(\text{UE}_{n, \mathcal{G}_d}^{N, h, q, \varepsilon} \bullet \left[\text{Tun}_1^{N+1} \boxminus \text{Aff}_{0, d, d, \mathcal{X}_{\omega_i}} \right] \right) (x) \\ &= \mathfrak{J}_\tau \left(\text{UE}_{n, \mathcal{G}_d}^{N, h, q, \varepsilon} \right) \circ \mathfrak{J}_\tau \left(\left[\text{Tun}_1^{N+1} \boxminus \text{Aff}_{0, d, d, \mathcal{X}_{\omega_i}} \right] \right) (x) \end{aligned}$$

Note that by Lemma 9.3.1 it holds that $\mathfrak{J}_\tau \left(\text{UE}_{n, \mathcal{G}_d}^{N, h, q, \varepsilon} \right) \in C(\mathbb{R}^{N+1} \times \mathbb{R}^d, \mathbb{R})$. Note also that by Lemma 6.2.6, Tun_1^{N+1} is continuous and by Lemma 5.5.2, $\text{Aff}_{0, d, d, \mathcal{X}_{\omega_i}}$ is continuous, and whence by Lemma 6.2.6 and Lemma 5.5.5 it is the case that $\mathfrak{J}_\tau \left(\left[\text{Tun}_1^{N+1} \boxminus \text{Aff}_{0, d, d, \mathcal{X}_{\omega_i}} \right] \right) (x) \in C(\mathbb{R}^{N+1} \times \mathbb{R}^d, \mathbb{R}^{N+1} \times \mathbb{R}^d)$. Finally, since the composition of continuous functions is continuous, and since we have functions $(\mathbb{R}^{N+1} \times \mathbb{R}^d) \mapsto (\mathbb{R}^{N+1} \times \mathbb{R}^d) \mapsto \mathbb{R}$ we have that $\mathfrak{J}_\tau \left(\text{UEX}_{n, \mathcal{G}_d, \omega_i}^{N, h, q, \varepsilon} \right) \in C(\mathbb{R}^{N+1} \times \mathbb{R}^d, \mathbb{R})$. This proves Item (i).

Note next that by Lemma 6.2.6, it is the case that $D \left(\text{Tun}_1^{N+1} \right) = D \left(\text{Aff}_{0, d, d, \mathcal{X}_{\omega_i}} \right) = 1$. Thus by Lemma 5.2.5 it is the case that $D \left(\text{UEX}_{n, \mathcal{G}_d, \omega_i}^{N, h, q, \varepsilon} \right) = D \left(\text{UE}_{n, \mathcal{G}_d}^{N, h, q, \varepsilon} \right)$. This proves Item (ii)

Next note that:

$$\mathbf{P} \left(\text{UEX}_{n, \mathcal{G}_d, \omega_i}^{N, h, q, \varepsilon} \right) = \mathbf{P} \left(\text{UE}_{n, \mathcal{G}_d}^{N, h, q, \varepsilon} \bullet \left[\text{Tun}_1^{N+1} \boxminus \text{Aff}_{0, d, d, \mathcal{X}_{\omega_i}} \right] \right) \quad (9.3.6)$$

Note carefully that Definition 6.2.4 tells us that $\text{Tun}_1^{N+1} = \text{Aff}_{\mathbb{I}_{N+1, N+1}, 0_{N+1}}$, and so by Lemma 5.5.6, it must be the case that $\text{Tun}_1^{N+1} \boxminus \text{Aff}_{0, d, d, \mathcal{X}_{\omega_i}}$ is also an affine neural network. Whence, Corollary

5.5.5.1 tells us that:

$$\begin{aligned}
\mathbb{P} \left(\text{UEX}_{n, \mathbf{G}_d, \omega_i}^{N, h, q, \varepsilon} \right) &= \mathbb{P} \left(\text{UE}_{n, \mathbf{G}_d}^{N, h, q, \varepsilon} \bullet \left[\text{Tun}_1^{N+1} \boxminus \text{Aff}_{0, d, \mathcal{X}_{\omega_i}} \right] \right) \\
&\leq \left[\max \left\{ 1, \frac{\mathbb{I} \left(\text{Tun}_1^{N+1} \boxminus \text{Aff}_{0, d, \mathcal{X}_{\omega_i}} \right) + 1}{\mathbb{I} \left(\text{UE}_{n, \mathbf{G}_d}^{N, h, q, \varepsilon} \right) + 1} \right\} \right] \cdot \mathbb{P} \left(\text{UE}_{n, \mathbf{G}_d}^{N, h, q, \varepsilon} \right) \\
&= \mathbb{P} \left(\text{UE}_{n, \mathbf{G}_d}^{N, h, q, \varepsilon} \right) \\
&\leq \frac{360q}{q-2} \left[\log_2 (\varepsilon^{-1}) + q + 1 \right] + 324 + 48n \\
&\quad + 24 \text{W}_H(\mathbf{G}_d) (\mathbf{G}_d) + 4 \max \left\{ \mathbb{P} \left(\text{E}_n^{N, h, q, \varepsilon} \right), \mathbb{P} (\mathbf{G}_d) \right\}
\end{aligned} \tag{9.3.7}$$

Finally, note that both $\text{Aff}_{W, b}$ and Tun_n^d are exact and contribute nothing to the uncertainty. Thus $\text{UEX}_{n, \mathbf{G}_d, \omega_i}^{N, h, q, \varepsilon}$ has the same error bounds as $\text{UE}_{n, \mathbf{G}_d}^{N, h, q, \varepsilon}$. That is to say that:

$$\begin{aligned}
&\left| \exp \left(\int_t^T f ds \right) \mathbf{u}_d^T (x) - \mathfrak{I}_\tau \left(\text{UEX}_{n, \mathbf{G}_d, \omega_i}^{N, h, q, \varepsilon} \right) (f ([\mathbf{x}]_*) \curvearrowright x) \right| \\
&\leq 3\varepsilon + 2\varepsilon \left| \mathbf{u}_d^T (t, x) \right|^q + 2\varepsilon \left| \exp \left(\int_a^b f dx \right) \right|^q + \varepsilon \left| \exp \left(\int_a^b f dx \right) - \mathbf{e} \right|^q - \mathbf{e} \mathbf{u}_d^T (x)
\end{aligned}$$

□

Corollary 9.3.1.1 (R—, 2024, Approximants for Brownian Motion). *Let $t \in (0, \infty)$ and $T \in (t, \infty)$. Let $(\Omega, \mathcal{F}, \mathbb{P})$ be a probability space. Let $n, N \in \mathbb{N}$, and $h \in (0, \infty)$. Let $\delta, \varepsilon \in (0, \infty)$, $q \in (2, \infty)$, satisfy that $\delta = \varepsilon (2^{q-1} + 1)^{-1}$. Let $f : [t, T] \rightarrow \mathbb{R}$ be continuous almost everywhere in $[t, T]$. Let it also be the case that $f = g \circ \mathfrak{h}$, where $\mathfrak{h} : [t, T] \rightarrow \mathbb{R}^d$, and $g : \mathbb{R}^d \rightarrow \mathbb{R}$. Let $t = t_0 \leq t_1 \leq \dots \leq t_{N-1} \leq t_N = T$ such that for all $i \in \{0, 1, \dots, N\}$ it is the case that $h = \frac{T-t}{N}$, and $t_i = t_0 + i \cdot h$. Let $\mathbf{t} = [t_0 \ t_1 \ \dots \ t_N]$ and as such let $f \left([\mathbf{t}]_{*,*} \right) = [f(t_0) \ f(t_1) \ \dots \ f(t_N)]$. Let $\text{E}_n^{N, h, q, \varepsilon} \in \text{NN}$ be the neural network given by:*

$$\text{E}_n^{N, h, q, \varepsilon} = \text{Xpn}_n^{q, \varepsilon} \bullet \text{Etr}^{N, h} \tag{9.3.8}$$

Let $u_d \in C^{1,2} ([0, T] \times \mathbb{R}^d, \mathbb{R})$ satisfy for all $d \in \mathbb{N}$, $t \in [0, T]$, $x \in \mathbb{R}^d$ that:

$$\left(\frac{\partial}{\partial t} u_d \right) (t, x) + (\nabla_x^2 u_d) (t, x) + \alpha_d (x) u_d (t, x) = 0 \tag{9.3.9}$$

Furthermore, let $\mathbf{u}_d^T(x) = u_d(T, x)$. Let $\mathbf{G}_d \subsetneq \mathbf{NN}$ be the neural networks which instantiate as $\mathbf{u}_d^T = \mathfrak{J}_\tau(\mathbf{G}_d) \in C(\mathbb{R}^d, \mathbb{R})$.

Let $\mathcal{W}^d : [0, T] \times \Omega \rightarrow \mathbb{R}^d$, $d \in \mathbb{N}$ be standard Brownian motions, and let $\mathcal{X}^{d,t,x} : [t, T] \times \Omega \rightarrow \mathbb{R}^d$, $d \in \mathbb{N}$, $t \in [0, T]$, $x \in \mathbb{R}^d$ be stochastic processes with continuous sample paths satisfying that for all $d \in \mathbb{N}$, $t \in [0, T]$, $s \in [t, T]$, $x \in \mathbb{R}^d$ we have \mathbb{P} -a.s. that:

$$\mathcal{X}_s^{d,t,x} = x + \int_s^t \sqrt{2d} d\mathcal{W}_r^d \quad (9.3.10)$$

It is then the case that for all $d \in \mathbb{N}$, $t \in [0, T]$, $x \in \mathbb{R}^d$ it holds that:

$$u_d(t, x) = \mathbb{E} \left[\exp \left(\int_t^T (\alpha_d \circ \mathcal{X}_r^{d,t,x}) dr \right) u_d \left(T, \mathcal{X}_T^{d,t,x} \right) \right] \quad (9.3.11)$$

Let $\mathbf{UE}_{n, \mathbf{G}_d}^{N,h,q,\varepsilon}$ be the neural network given as:

$$\mathbf{UE}_{n, \mathbf{G}_d}^{N,h,q,\varepsilon} = \text{Prd}^{q,\varepsilon} \bullet \left[\mathbf{E}_n^{N,h,q,\varepsilon} \diamond \mathbf{G}_d \right] \quad (9.3.12)$$

Finally let $\mathbf{UEX}_{n, \mathbf{G}_d, \omega_i}^{N,h,q,\varepsilon}$ be given by:

$$\mathbf{UEX}_{n, \mathbf{G}_d, \omega_i}^{N,h,q,\varepsilon} = \mathbf{UE}_{n, \mathbf{G}_d}^{N,h,q,\varepsilon} \bullet \left[\mathbf{Tun}_1^{N+1} \boxminus \mathbf{Aff}_{0,d,\mathcal{X}_{\omega_i}} \right] \quad (9.3.13)$$

It is then the case that for all $\mathbf{x} = \{x_0, x_1, \dots, x_N\} \in \mathbb{R}^{N+1}$ and $x \in \mathbb{R}^d$ that:

It is also the case that:

$$\begin{aligned} & \left| \exp \left(\int_t^T f ds \right) \mathbf{u}_d^T(x) - \mathfrak{J}_\tau \left(\mathbf{UEX}_{n, \mathbf{G}_d, \omega_i}^{N,h,q,\varepsilon} \right) (f([\mathbf{x}]_*) \curvearrowright x) \right| \\ & \leq 3\varepsilon + 2\varepsilon |\mathbf{u}_d^T(t, x)|^q + 2\varepsilon \left| \exp \left(\int_a^b f dx \right) \right|^q + \varepsilon \left| \exp \left(\int_a^b f dx \right) - \mathbf{e} \right|^q - \mathbf{e} \mathbf{u}_d^T(x) \end{aligned}$$

Where, as per Lemma 9.1.1, \mathbf{e} is defined as:

$$\left| \mathbf{E}_n^{N,h,q,\varepsilon} (f([\mathbf{x}]_*)) - \exp \left(\int_a^b f dx \right) \right| \leq \mathbf{e} \quad (9.3.14)$$

Proof. Note that for a fixed $T \in (0, \infty)$ it is the case that $u_d(t, x) \in C^{1,2}([0, T] \times \mathbb{R}^d, \mathbb{R})$ projects

down to a function $u_d^T(x) \in C^2(\mathbb{R}^d, \mathbb{R})$. Furthermore given a probability space $(\Omega, \mathcal{F}, \mathbb{P})$ and a stochastic process $\mathcal{X}^{d,t,x} : [t, T] \times \Omega \rightarrow \mathbb{R}^d$, for a fixed outcome space $\omega_i \in \Omega$ it is the case that $\mathcal{X}^{d,t,x}$ projects down to $\mathcal{X}_{\omega_i}^{d,t,x} : [t, T] \rightarrow \mathbb{R}^d$. Thus given $\alpha_d : \mathbb{R}^d \rightarrow \mathbb{R}$ that is infinitely often differentiable, we get that $\alpha_d \circ \mathcal{X}_{\omega_i}^{d,t,x} : [t, T] \rightarrow \mathbb{R}$.

Taken together with Lemma 9.3.1 with $x \curvearrowright \mathcal{X}_{r,\omega}^{d,t,x}$, $f \curvearrowright \alpha_d \circ \mathcal{X}_{\omega_i}^{d,t,x}$, $b \curvearrowright T$, $a \curvearrowright t$, and $u_d^T(x) \curvearrowright u_d(T, \mathcal{X}_{\omega_i}^{d,t,x})$, our error term is rendered as is rendered as:

$$\begin{aligned} & \left| \exp \left(\int_t^T \left(\alpha_d \circ \mathcal{X}_{r,\omega_i}^{d,t,x} ds \right) \right) u_d \left(T, \mathcal{X}_{\omega_i}^{d,t,x} \right) - \mathfrak{J}_r \left(\text{UEX}_{N,\mathbf{G}_d,\omega_i}^{N,h,q,\varepsilon} \right) \right| \\ & \leq 3\varepsilon + 2\varepsilon \left| u_d \left(T, \mathcal{X}_{r,\omega_i}^{d,t,x} \right) \right|^q + 2\varepsilon \left| \exp \left(\int_a^b f dx \right) \right|^q + \varepsilon \left| \exp \left(\int_a^b f dx \right) - e \right|^q - \varepsilon u_d \left(T, \mathcal{X}_{r,\omega_i}^{d,t,x} \right) \end{aligned}$$

This completes the proof of the lemma. □

Remark 9.3.2. *Diagrammatically, this can be represented as:*

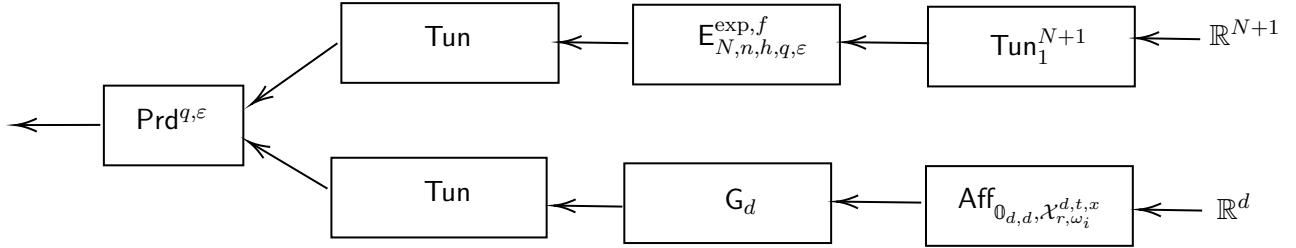

9.4 The UES network

Lemma 9.4.1. *Let $\nu_1, \nu_2, \dots, \nu_n \in \mathbb{N}\mathbb{N}$ such that for all $i \in \{1, 2, \dots, n\}$ it is the case that $\mathbf{O}(\nu_i) = 1$, and it is also the case that $\mathbf{D}(\nu_1) = \mathbf{D}(\nu_2) = \dots = \mathbf{D}(\nu_n)$. Let $x_1 \in \mathbb{R}^{l(\nu_1)}, x_2 \in \mathbb{R}^{l(\nu_2)}, \dots, x_n \in \mathbb{R}^{l(\nu_n)}$ and $\mathfrak{x} \in \mathbb{R}^{\sum_{i=1}^n l(\nu_i)}$. It is then the case that we have that:*

$$\mathfrak{J}_r(\text{Sum}_{n,1} \bullet [\boxplus_{i=1}^n \nu_i])(\mathfrak{x}) = \sum_{i=1}^n \mathfrak{J}_r(\nu_i)(x_i) \quad (9.4.1)$$

Proof. Throughout the proof let $x_1 \in \mathbb{R}^{l(\nu_1)}, x_2 \in \mathbb{R}^{l(\nu_2)}, \dots, x_n \in \mathbb{R}^{l(\nu_n)}$ and $\mathfrak{x} \in \mathbb{R}^{\sum_{i=1}^n l(\nu_i)}$ such

that $\mathfrak{x} = x_1 \frown x_2 \frown \cdots \frown x_n$. Observe that by Lemma 5.2.5 we have that:

$$\mathfrak{J}_{\mathfrak{r}}(\text{Sum}_{n,1} \bullet [\boxplus_{i=1}^n \nu_i])(\mathfrak{x}) = \mathfrak{J}_{\mathfrak{r}}(\text{Sum}_{n,1}) \circ \mathfrak{J}_{\mathfrak{r}}(\boxplus_{i=1}^n \nu_i)(\mathfrak{x}) \quad (9.4.2)$$

Note however that Definition 5.1.4 yields that $\mathfrak{J}_{\mathfrak{r}}(\text{Sum}_{n,1})(x) = [1 \ 1 \ \cdots \ 1] \cdot x + 0$ for $x \in \mathbb{R}^n$. On the other hand $\mathcal{O}(\boxplus_{i=1}^n \nu_i) = n$ and furthermore by Lemma 5.3.3 it is the case for $\mathfrak{x} \in \mathbb{R}^{\sum_{i=1}^n l(\nu_i)}$ that $\mathfrak{J}_{\mathfrak{r}}(\boxplus_{i=1}^n \nu_i)(\mathfrak{x}) = \mathfrak{J}_{\mathfrak{r}}(\nu_1)(x_1) \frown \mathfrak{J}_{\mathfrak{r}}(\nu_2)(x_2) \frown \cdots \frown \mathfrak{J}_{\mathfrak{r}}(\nu_n)(x_n)$. Thus $\mathfrak{J}_{\mathfrak{r}}(\text{Sum}_{n,1} \bullet [\boxplus_{i=1}^n \nu_i])(\mathfrak{x})$ is rendered as:

$$\begin{bmatrix} 1 & 1 & \cdots & 1 \end{bmatrix} \begin{bmatrix} \mathfrak{J}_{\mathfrak{r}}(\nu_1)(x_1) \\ \mathfrak{J}_{\mathfrak{r}}(\nu_2)(x_2) \\ \vdots \\ \mathfrak{J}_{\mathfrak{r}}(\nu_n)(x_n) \end{bmatrix} + 0 = \sum_{i=1}^n \mathfrak{J}_{\mathfrak{r}}(\nu_i)(x_i) \quad (9.4.3)$$

This completes the proof of the lemma. \square

Lemma 9.4.2. *Let $\nu_1, \nu_2, \dots, \nu_n \in \mathbb{NN}$ with $l(\nu_1) = l(\nu_2) = \dots = l(\nu_n)$ and $\mathcal{O}(\nu_1) = \mathcal{O}(\nu_2) = \dots = \mathcal{O}(\nu_n) = 1$ such that for all $i \in \{1, 2, \dots, n\}$ it is the case that there exists $f_i \in C(\mathbb{R}^{l(\nu_i)}, \mathbb{R})$, and $\varepsilon_i \in (0, \infty)$, where for all $x_i \in \mathbb{R}^{l(\nu_i)}$, it is the case that $|\mathfrak{J}_{\mathfrak{r}}(\nu_i)(x_i) - f_i(x_i)| \leq \varepsilon_i$. It is then the case that for all $\mathfrak{x} \in \mathbb{R}^{n \cdot l(\nu_1)}$ and $x_i \in \mathbb{R}^{l(\nu_i)}$ with $\mathfrak{x} = x_1 \frown x_2 \frown \cdots \frown x_n$ that:*

$$\|\mathfrak{J}_{\mathfrak{r}}(\boxplus_i^n \nu_i)(\mathfrak{x}) - [\frown_{i=1}^n f_i](\mathfrak{x})\|_1 \leq \sum_{i=1}^n \varepsilon_i \quad (9.4.4)$$

Proof. We will prove this with induction. This is straight-forward for the case where we have just one neural network where for all $x \in \mathbb{R}^{l(\nu_1)}$ it is the case that $\|\mathfrak{J}_{\mathfrak{r}}(\nu_1)(x) - f(x)\|_1 \leq \varepsilon_1 = \sum_{i=1}^1 \varepsilon_i$. Suppose now, that, $\|\mathfrak{J}_{\mathfrak{r}}(\boxplus_i^n \nu_i)(\mathfrak{x}) - [\frown_{i=1}^n f_i](\mathfrak{x})\|_1 \leq \sum_{i=1}^n \varepsilon_i$ holds true for all cases upto and including n . Consider what happens when we have a triple, a function f_{n+1} , a neural network ν_{n+1} , and $\varepsilon_{n+1} \in (0, \infty)$ with a maximum error over all $x \in \mathbb{R}^{l(\nu_1)}$ of $|f_{n+1}(x) - \mathfrak{J}_{\mathfrak{r}}(\nu_{n+1})(x)| \leq \varepsilon_{n+1}$.

Then Lemma 5.3.3, Corollary 1.2.33.1, and the triangle inequality tells us that:

$$\begin{aligned}
& \|\mathfrak{J}_{\mathbf{r}}(\Theta_i^{n+1}\nu_i)(\mathbf{x}) - [\bigwedge_{i=1}^{n+1} f_i](\mathbf{x})\|_1 \\
& \leq \|\mathfrak{J}_{\mathbf{r}}(\Theta_i^n\nu_i)(\mathbf{x}) - [\bigwedge_{i=1}^n f_i](\mathbf{x})\|_1 + |f_{n+1}(x) - \mathfrak{J}_{\mathbf{r}}(\nu_{n+1})(x)| \\
& \leq \sum_{i=1}^{n+1} \varepsilon_i
\end{aligned} \tag{9.4.5}$$

This proves the inductive case and hence the Lemma. \square

Lemma 9.4.3 (R—, 2024, Approximants for Brownian Motion). *Let $t \in (0, \infty)$ and $T \in (t, \infty)$. Let $(\Omega, \mathcal{F}, \mathbb{P})$ be a probability space. Let $n, N \in \mathbb{N}$, and $h \in (0, \infty)$. Let $\delta, \varepsilon \in (0, \infty)$, $q \in (2, \infty)$, satisfy that $\delta = \varepsilon(2^{q-1} + 1)^{-1}$. Let $f : [t, T] \rightarrow \mathbb{R}$ be continuous almost everywhere in $[t, T]$. Let it also be the case that $f = g \circ \mathfrak{h}$, where $\mathfrak{h} : [t, T] \rightarrow \mathbb{R}^d$, and $g : \mathbb{R}^d \rightarrow \mathbb{R}$. Let $t = t_0 \leq t_1 \leq \dots \leq t_{N-1} \leq t_N = T$ such that for all $i \in \{0, 1, \dots, N\}$ it is the case that $h = \frac{T-t}{N}$, and $t_i = t_0 + i \cdot h$. Let $\mathbf{t} = [t_0 \ t_1 \ \dots \ t_N]$ and as such let $f([\mathbf{t}]_{*,*}) = [f(t_0) \ f(t_1) \ \dots \ f(t_N)]$. Let $u_d \in C(\mathbb{R}^d, \mathbb{R})$ satisfy for all $d \in \mathbb{N}$, $t \in [0, T]$, $x \in \mathbb{R}^d$ that:*

$$\left(\frac{\partial}{\partial t} u_d \right) (t, x) + (\nabla_x^2 u_d) (t, x) + \alpha_d(x) u_d(t, x) = 0 \tag{9.4.6}$$

Furthermore, let $\mathbf{u}_d^T(x) = u_d(T, x)$. Let $\mathbf{G}_d \subsetneq \mathbf{NN}$ be the neural network which instantiates as $\mathbf{u}_d^T = \mathfrak{J}_{\mathbf{r}}(\mathbf{G}_d) \in C(\mathbb{R}^d, \mathbb{R})$.

Let $\mathcal{W}^d : [0, T] \times \Omega \rightarrow \mathbb{R}^d$, $d \in \mathbb{N}$ be standard Brownian motions, and let $\mathcal{X}^{d,t,x} : [t, T] \times \Omega \rightarrow \mathbb{R}^d$, $d \in \mathbb{N}$, $t \in [0, T]$, $x \in \mathbb{R}^d$ be stochastic processes with continuous sample paths satisfying that for all $d \in \mathbb{N}$, $t \in [0, T]$, $s \in [t, T]$, $x \in \mathbb{R}^d$ we have \mathbb{P} -a.s, that:

$$\mathcal{X}_s^{d,t,x} = x + \int_s^t \sqrt{2} d\mathcal{W}_r^d \tag{9.4.7}$$

It is then the case that for all $d \in \mathbb{N}$, $t \in [0, T]$, $x \in \mathbb{R}^d$ it holds that:

$$u_d(t, x) = \mathbb{E} \left[\exp \left(\int_t^T (\alpha_d \circ \mathcal{X}_r^{d,t,x}) dr \right) u_d \left(T, \mathcal{X}_T^{d,t,x} \right) \right] \tag{9.4.8}$$

Let $E_n^{N,h,q,\varepsilon} \subsetneq \text{NN}$ be neural networks given by:

$$E_n^{N,h,q,\varepsilon} = \text{Xpn}_n^{q,\varepsilon} \bullet \text{Etr}^{N,h} \quad (9.4.9)$$

Furthermore, let $G_d \in \text{NN} \subsetneq \text{NN}$ be neural networks which instantiate as $u_d = \mathfrak{J}_\tau(G_d) \in C(\mathbb{R}^d, \mathbb{R})$.

Furthermore, let $\text{UE}_{n,G_d}^{N,h,q,\varepsilon} \subsetneq \text{NN}$ be neural networks given by:

$$\text{UE}_{n,G_d}^{N,h,q,\varepsilon} = \text{Prd}^{q,\varepsilon} \bullet \left[E_{n,h,q,\varepsilon}^{N,h,q,\varepsilon} \diamond G_d \right] \quad (9.4.10)$$

Furthermore, let $\text{UEX}_{n,G_d,\omega_i}^{N,h,q,\varepsilon} \subsetneq \text{NN}$ be neural networks given by:

$$\text{UEX}_{n,G_d,\omega_i}^{N,h,q,\varepsilon} = \text{UE}_{n,G_d}^{N,h,q,\varepsilon} \bullet \left[\text{Tun}_1^{N+1} \boxplus \text{Aff}_{0,d,d,\mathcal{X}_{\omega_i}} \right] \quad (9.4.11)$$

Finally let $\text{UES}_{n,G_d,\Omega,n}^{N,h,q,\varepsilon} \subsetneq \text{NN}$ be neural networks which, for $\omega_i \in \Omega$, is given as:

$$\text{UES}_{n,G_d,\Omega,n}^{N,h,q,\varepsilon} = \frac{1}{\mathbf{n}} \triangleright \left(\text{Sum}_{\mathbf{n},1} \bullet \left[\boxplus_{i=1}^{\mathbf{n}} \text{UEX}_{n,G_d,\omega_i}^{N,h,q,\varepsilon} \right] \right) \quad (9.4.12)$$

It is then the case that for all $\mathfrak{X} \in \mathbb{R}^{n(N+1)} \times \mathbb{R}^{nd}$:

(i) $\mathfrak{J}_\tau \left(\text{UES}_{n,G_d,\Omega,n}^{N,h,q,\varepsilon} \right) \in C \left(\mathbb{R}^{n(N+1)} \times \mathbb{R}^{nd}, \mathbb{R} \right)$

(ii) $D \left(\text{UES}_{n,G_d,\Omega,n}^{N,h,q,\varepsilon} \right) \leq \begin{cases} \frac{q}{q-2} [\log_2(\varepsilon^{-1}) + q] + D(G_d) - 1 & : n = 0 \\ \frac{q}{q-2} [\log_2(\varepsilon^{-1}) + q] + \max \{ D(E_n^{N,h,q,\varepsilon}), D(G_d) \} - 1 & : n \in \mathbb{N} \end{cases}$

(iii) It is also the case that:

$$\begin{aligned} P \left(\text{UES}_{n,G_d,\Omega,n}^{N,h,q,\varepsilon} \right) &\leq P(\text{Prd}^{q,\varepsilon}) + 2 \left(\max \left\{ P \left(E_n^{N,h,q,\varepsilon} \right), P(G_d) \right\} \right)^2 \\ &\quad + 8 \max \{ (1 + 4n), W_{H(G_d)}(G_d) \} \end{aligned}$$

(iv) It is also the case that:

$$\begin{aligned} & \left| \mathbb{E} \left[\exp \left(\int_t^T f \left(\mathcal{X}_r^{d,t,x} \right) ds \right) u_d \left(T, \mathcal{X}_r^{d,t,x} \right) \right] - \mathfrak{J}_\tau \left(\text{UES}_{n, \mathbb{G}_d, \Omega, \mathbf{n}}^{N, h, q, \varepsilon} \right) \right| \\ & \leq 3\varepsilon + 2\varepsilon \left| \mathbf{u}_d^T(x) \right|^q + 2\varepsilon \left| \exp \left(\int_a^b f dx \right) \right|^q + \varepsilon \left| \exp \left(\int_a^b f dx \right) - \mathbf{e} \right|^q - \mathbf{e} \mathbf{u}_d^T(x) \end{aligned} \quad (9.4.13)$$

Where, as per Lemma 9.1.1, \mathbf{e} is defined as:

$$\left| \mathbf{E}_n^{N, h, q, \varepsilon} - \exp \left(\int_a^b f dx \right) \right| \leq \mathbf{e} \quad (9.4.14)$$

Proof. Note that for all $i \in \{1, 2, \dots, \mathbf{n}\}$, Lemma 9.3 tells us that $\mathfrak{J}_\tau \left(\text{UEX}_{n, \mathbb{G}_d, \omega_i}^{N, h, q, \varepsilon} \right) \in C \left(\mathbb{R}^{N+1} \times \mathbb{R}^d, \mathbb{R} \right)$. Lemma 5.6.17 and Lemma 5.6.16, thus tells us that $\mathfrak{J}_\tau \left(\left(\bigoplus_{i=1}^{\mathbf{n}} \left[\text{UEX}_{n, \mathbb{G}_d, \omega_i}^{N, h, q, \varepsilon} \right] \right) \right) = \sum_{i=1}^{\mathbf{n}} \left[\mathfrak{J}_\tau \left(\text{UEX}_{n, \mathbb{G}_d, \omega_i}^{N, h, q, \varepsilon} \right) \right]$. The sum of continuous functions is continuous. Note next that $\frac{1}{\mathbf{n}} \triangleright$ is an affine neural network, and hence, by Lemma 5.5.2, must be continuous.

Then Lemmas 5.2.5, 5.3.8, and the fact that by Lemma 9.3 each of the individual stacked $\text{UEX}_{n, \mathbb{G}_d, \omega_i}^{N, h, q, \varepsilon}$ neural networks is continuous then ensures us that it must therefore be the case that: $\mathfrak{J}_\tau \left(\text{UES}_{n, \mathbb{G}_d, \Omega, \mathbf{n}}^{N, h, q, \varepsilon} \right) \in C \left(\mathbb{R}^{\mathbf{n}(N+1)} \times \mathbb{R}^{\mathbf{n}d}, \mathbb{R} \right)$. This proves Item (i).

Next note that by construction each $\text{UEX}_{n, \mathbb{G}_d, \omega_i}^{N, h, q, \varepsilon}$ has the same depth, indeed for each i the only thing different for each of the $\text{UEX}_{n, \mathbb{G}_d, \omega_i}^{N, h, q, \varepsilon}$ is the parameters themselves and not the count or depth or layer architecture. Note that $D(\text{Sum}_{\mathbf{n}, 1}) = D\left(\frac{1}{\mathbf{n}} \triangleright\right) = D\left(\text{Aff}_{\frac{1}{\mathbf{n}}, 0}\right) = 1$.

Whence by Lemma 5.2.5 it is the case that $D\left(\text{UES}_{n, \mathbb{G}_d, \Omega, \mathbf{n}}^{N, h, q, \varepsilon}\right) = D\left(\text{UEX}_{n, \mathbb{G}_d, \omega_i}^{N, h, q, \varepsilon}\right)$. This then proves Item (ii).

Next, observe that each of the UEX networks has the same architecture by construction. Corollary 5.3.5.1 then yields that:

$$\mathbb{P} \left(\bigoplus_{i=1}^{\mathbf{n}} \text{UEX}_{n, \mathbb{G}_d, \omega_i}^{N, h, q, \varepsilon} \right) \leq \mathbf{n}^2 \cdot \mathbb{P} \left(\text{UEX}_{n, \mathbb{G}_d, \omega_i}^{N, h, q, \varepsilon} \right) \quad (9.4.15)$$

Note for instance also that by Remark 5.5.3, it is the case that $\mathbb{P}(\text{Sum}_{\mathbf{n}, 1}) = \mathbf{n} + 1$. Furthermore, since the output of the Sum neural network has length one, by Definition 5.7.1 it is the case that

$P\left(\frac{1}{n} \triangleright\right) = 2$. Then Corollary 5.5.5.1 leads us to conclude that:

$$\begin{aligned}
& P\left(\text{Sum}_{n,1} \bullet \left[\Xi_{i=1}^n \text{UEX}_{n, G_d, \omega_i}^{N, h, q, \varepsilon}\right]\right) \leq P\left(\Xi_{i=1}^n \text{UEX}_{n, G_d, \omega_i}^{N, h, q, \varepsilon}\right) \\
& \leq n^2 \cdot P\left(\text{UEX}_{n, G_d, \omega_i}^{N, h, q, \varepsilon}\right) \\
& \leq n^2 \cdot \left[\frac{360q}{q-2} [\log_2(\varepsilon^{-1}) + q + 1] + 324 + 48n\right. \\
& \quad \left.+ 24 W_{H(G_d)}(G_d) + 4 \max\left\{P\left(E_n^{N, h, q, \varepsilon}\right), P(G_d)\right\}\right]
\end{aligned} \tag{9.4.16}$$

and therefore that:

$$\begin{aligned}
& P\left(\frac{1}{n} \triangleright \left(\text{Sum}_{n,1} \bullet \left[\Xi_{i=1}^n \text{UEX}_{n, G_d, \omega_i}^{N, h, q, \varepsilon}\right]\right)\right) \\
& \leq P\left(\text{Sum}_{n,1} \bullet \left[\Xi_{i=1}^n \text{UEX}_{n, G_d, \omega_i}^{N, h, q, \varepsilon}\right]\right) \\
& \leq P\left(\Xi_{i=1}^n \text{UEX}_{n, G_d, \omega_i}^{N, h, q, \varepsilon}\right) \\
& \leq n^2 \cdot P\left(\text{UEX}_{n, G_d, \omega_i}^{N, h, q, \varepsilon}\right) \\
& \leq n^2 \cdot \left[\frac{360q}{q-2} [\log_2(\varepsilon^{-1}) + q + 1] + 324 + 48n\right. \\
& \quad \left.+ 24 W_{H(G_d)}(G_d) + 4 \max\left\{P\left(E_n^{N, h, q, \varepsilon}\right), P(G_d)\right\}\right]
\end{aligned} \tag{9.4.17}$$

Now observe that by the triangle inequality, we have that:

$$\begin{aligned}
& \left| \mathbb{E} \left[\exp \left(\int_t^T f \left(\mathcal{X}_{r, \Omega}^{d, t, x} \right) ds \right) u_d^T \left(\mathcal{X}_{r, \Omega}^{d, t, x} \right) \right] - \mathfrak{J}_\tau \left(\text{UES}_{n, G_d, \Omega, n}^{N, h, q, \varepsilon} \right) \right| \\
& = \left| \mathbb{E} \left[\exp \left(\int_t^T f \left(\mathcal{X}_{r, \omega_i}^{d, t, x} \right) ds \right) u_d^T \left(\mathcal{X}_{r, \omega_i}^{d, t, x} \right) \right] - \mathfrak{J}_\tau \left[\frac{1}{n} \triangleright \left(\text{Sum}_{n,1} \bullet \left[\Xi_{i=1}^n \text{UEX}_{n, G_d, \omega_i}^{N, h, q, \varepsilon} \right] \right) \right] \right| \\
& \leq \left| \mathbb{E} \left[\exp \left(\int_t^T f \left(\mathcal{X}_{r, \omega_i}^{d, t, x} \right) ds \right) u_d^T \left(\mathcal{X}_{r, \omega_i}^{d, t, x} \right) \right] - \frac{1}{n} \left[\sum_{i=1}^n \left[\exp \left(\int_t^T f \left(\mathcal{X}_{r, \omega_i}^{d, t, x} \right) ds \right) \cdot u_d^T \left(\mathcal{X}_{r, \omega_i}^{d, t, x} \right) \right] \right] \right| \\
& + \left| \frac{1}{n} \left[\sum_{i=1}^n \left[\exp \left(\int_t^T f \left(\mathcal{X}_{r, \omega_i}^{d, t, x} \right) ds \right) \cdot u_d^T \left(\mathcal{X}_{r, \omega_i}^{d, t, x} \right) \right] \right] - \mathfrak{J}_\tau \left[\frac{1}{n} \triangleright \left(\text{Sum}_{n,1} \bullet \left[\Xi_{i=1}^n \text{UEX}_{n, G_d, \omega_i}^{N, h, q, \varepsilon} \right] \right) \right] \right|
\end{aligned} \tag{9.4.18}$$

Observe that by the triangle inequality, the absolute homogeneity condition for norms, the fact that the Brownian motions are independent of each other, Lemma 9.4.1, the fact that $n \in \mathbb{N}$, the

fact that the upper limit of error remains bounded by the same bound for all $\omega_i \in \Omega$, and Lemma 9.4.2, then renders the second summand as:

$$\begin{aligned}
& \left| \frac{1}{n} \left[\sum_{i=1}^n \left[\exp \left(\int_t^T f \left(\mathcal{X}_{r,\omega_i}^{d,t,x} \right) ds \cdot u_d^T \left(\mathcal{X}_{r,\omega_i}^{d,t,x} \right) \right) \right] - \mathfrak{J}_\tau \left[\frac{1}{n} \triangleright \left(\text{Sum}_{n,1} \bullet \left[\boxplus_{i=1}^n \text{UEX}_{n,\mathbb{G}_d,\omega_i}^{N,h,q,\varepsilon} \right] \right) \right] \right| \\
& \leq \left| \frac{1}{n} \left[\sum_{i=1}^n \exp \left(\int_t^T f \left(\mathcal{X}_{r,\omega_i}^{d,t,x} \right) ds \cdot u_d^T \left(\mathcal{X}_{r,\omega_i}^{d,t,x} \right) \right) \right] - \frac{1}{n} \left[\sum_{i=1}^n \left(\mathfrak{J}_\tau \left[\text{UEX}_{n,\mathbb{G}_d,\omega_i}^{N,h,q,\varepsilon} \right] \right) \right] \right| \\
& \leq \frac{1}{n} \sum_{i=1}^n \left| \exp \left(\int_t^T f \left(\mathcal{X}_{r,\omega_i}^{d,t,x} \right) ds \cdot u_d^T \left(\mathcal{X}_{r,\omega_i}^{d,t,x} \right) \right) - \text{UEX}_{n,\mathbb{G}_d,\omega_i}^{N,h,q,\varepsilon} \right| \\
& \leq \left| \exp \left(\int_t^T f \left(\mathcal{X}_{r,\omega_i}^{d,t,x} \right) ds \cdot u_d^T \left(\mathcal{X}_{r,\omega_i}^{d,t,x} \right) \right) - \text{UEX}_{n,\mathbb{G}_d,\omega_i}^{N,h,q,\varepsilon} \right|
\end{aligned} \tag{9.4.19}$$

Note for the first summand that it is in $\mathcal{O} \left(\frac{1}{\sqrt{n}} \right)$. Notice that both f and u_d^T are continuous functions for $d \in \mathbb{N}$. Note also that $F : [t, T] \rightarrow \mathbb{R}$ defined as:

$$F(x) := \int_t^x f(x) dx \tag{9.4.20}$$

is continuous on $[t, T]$. Thus, notice that (Rio, 2009, Theorem 2.1) with k

□

Remark 9.4.4. *Note that diagrammatically, this can be represented as in figure below.*

Remark 9.4.5. *It may be helpful to think of this as a very crude form of ensembling.*

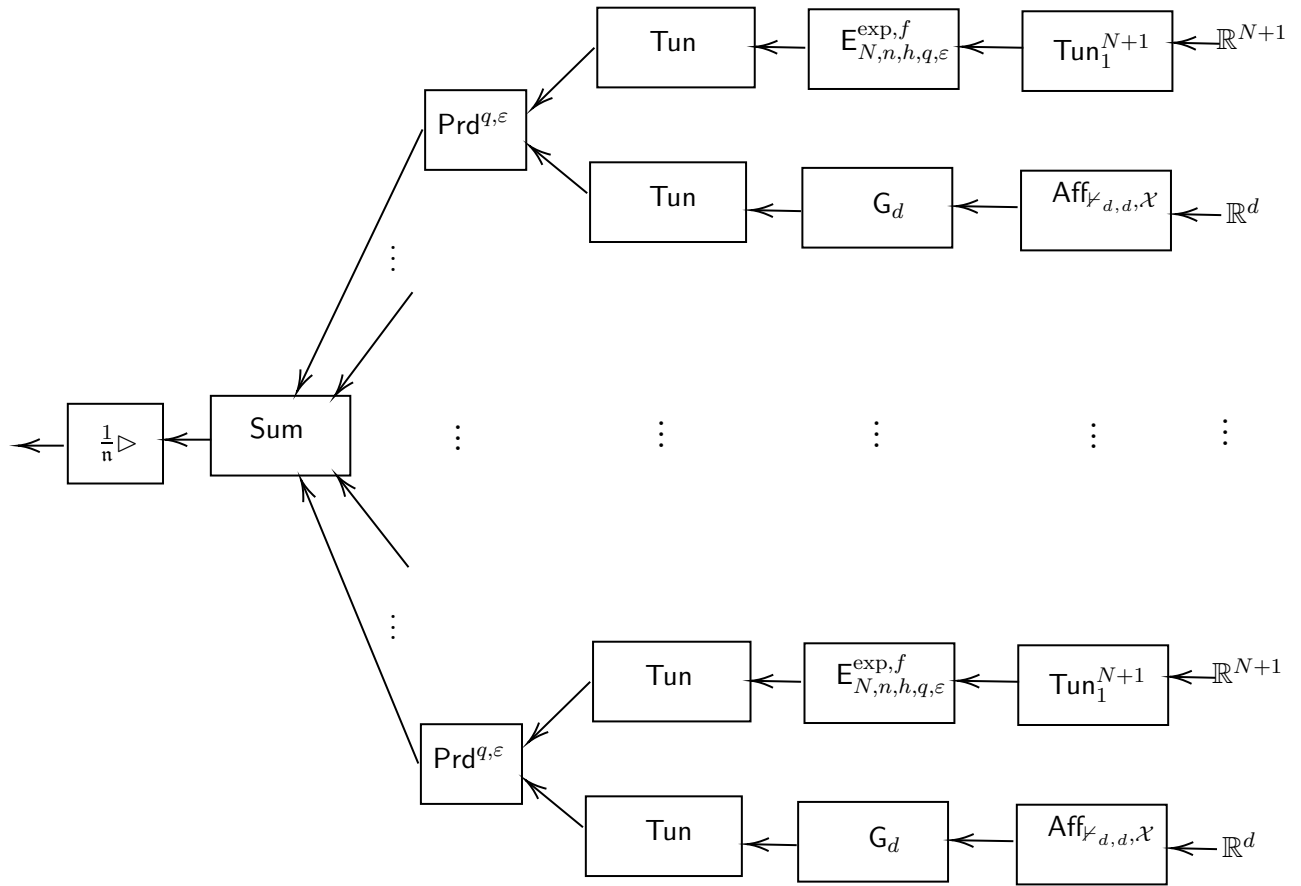

Figure 9.2: Neural network diagram for the UES network.

Chapter 10

Conclusions and Further Research

We will present three avenues of further research and related work on parameter estimates here.

10.1 Further operations and further kinds of neural networks

Note, for instance, that several classical operations are done on neural networks that have yet to be accounted for in this framework and talked about in the literature. We will discuss two of them *dropout* and *dilation* and provide lemmas that may be useful to future research.

10.1.1 Mergers and Dropout

Definition 10.1.1 (Hadamard Product). *Let $m, n \in \mathbb{N}$. Let $A, B \in \mathbb{R}^{m \times n}$. For all $i \in \{1, 2, \dots, m\}$ and $j \in \{1, 2, \dots, n\}$ define the Hadamard product $\odot : \mathbb{R}^{m \times n} \times \mathbb{R}^{m \times n} \rightarrow \mathbb{R}^{m \times n}$ as:*

$$A \odot B := [A \odot B]_{i,j} = [A]_{i,j} \times [B]_{i,j} \quad \forall i, j \quad (10.1.1)$$

Definition 10.1.2 (Scalar product of weights). *Let $\nu \in \mathbb{NN}$, $L \in \mathbb{N}$, $i, j, k \in \mathbb{N}$, and $c \in \mathbb{R}$. Assume also that $\mathbb{L}(\nu) = (l_0, l_1, l_2, \dots, l_L)$. Assume then that the neural network is given by $\nu = ((W_1, b_1), (W_2, b_2), \dots, (W_L, b_L))$. We will denote by $c^{\otimes i,j} \nu$ as the neural network which, for $i \in \mathbb{N} \cap [1, L-1]$, $j \in \mathbb{N} \cap [1, l_i]$, is given by $c^{\otimes i,j} \nu = ((W_1, b_1), (W_2, b_2), \dots, (\tilde{W}_i, b_i), (\tilde{W}_{i+1}, b_{i+1}), \dots, (W_L, b_L))$*

where it is the case that:

$$\tilde{W}_i = \left(\mathbb{1}_{l_i, l_i}^{j, j, c^{-1}} + \mathbb{I}_{l_i} \right) W_i \quad (10.1.2)$$

Definition 10.1.3 (The Dropout Operator). *Let $\nu \in \text{NN}$, $L \in \mathbb{N}$, $i_1, i_2, \dots, i_k, j, k \in \mathbb{N}$, and $c_1, c_2, \dots, c_k \in \mathbb{R}$. Assume also that $\mathbf{L}(\nu) = (l_0, l_1, l_2, \dots, l_L)$. Assume then that the neural network is given by $\nu = ((W_1, b_1), (W_2, b_2), \dots, (W_L, b_L))$. We will denote by $\text{Dropout}_n^{\text{Unif}}(\nu)$ the neural network that is given by:*

$$0 \otimes^{i_1, j_1} \left(0 \otimes^{i_2, j_2} \left(\dots 0 \otimes^{i_n, j_n} \nu \dots \right) \right) \quad (10.1.3)$$

Where for each $k \in \{1, 2, \dots, n\}$ it is the case that $i \sim \text{Unif}\{1, L-1\}$ and $j \sim \text{Unif}\{1, l_j\}$

We will also define the dropout operator introduced in [Srivastava et al. \(2014\)](#).

Definition 10.1.4 (Realization with dropout). *Let $\nu \in \text{NN}$, $L, n \in \mathbb{N}$, $p \in (0, 1)$, $\mathbf{L}(\nu) = (l_0, l_1, \dots, B_L)$, and that $\text{NN} = ((W_1, b_1), (W_2, b_2), \dots, (W_L, b_L))$. Let it be the case that for each $n \in \mathbb{N}$, $\rho_n = \{x_1, x_2, \dots, x_n\} \in \mathbb{R}^n$ where for each $i \in \{1, 2, \dots, n\}$ it is the case that $x_i \sim \text{Bern}(p)$. We will then denote $\mathfrak{J}_\tau^D(\nu) \in C(\mathbb{R}^{\mathbf{l}(\nu)}, \mathbb{R}^{\mathbf{O}(\nu)})$, the continuous function given by:*

$$\mathfrak{J}_\tau^D(\nu) = \rho_{l_L} \odot \tau(W_L(\rho_{l_{L-1}} \odot \tau(W_{L-1}(\dots) + b_{L-1})) + b_L) \quad (10.1.4)$$

Bibliography

- Arik, S. O. and Pfister, T. (2021a). TabNet: Attentive Interpretable Tabular Learning. *Proceedings of the AAAI Conference on Artificial Intelligence*, 35(8):6679–6687. Number: 8.
- Arik, S. n and Pfister, T. (2021b). TabNet: Attentive Interpretable Tabular Learning. *Proceedings of the AAAI Conference on Artificial Intelligence*, 35(8):6679–6687. Number: 8.
- Bass, R. F. (2011). *Brownian Motion*, page 6–12. Cambridge Series in Statistical and Probabilistic Mathematics. Cambridge University Press.
- Beck, C., Gonon, L., Hutzenthaler, M., and Jentzen, A. (2021a). On existence and uniqueness properties for solutions of stochastic fixed point equations. *Discrete & Continuous Dynamical Systems - B*, 26(9):4927.
- Beck, C., Hutzenthaler, M., and Jentzen, A. (2021b). On nonlinear Feynman–Kac formulas for viscosity solutions of semilinear parabolic partial differential equations. *Stochastics and Dynamics*, 21(08).
- Beck, C., Hutzenthaler, M., and Jentzen, A. (2021c). On nonlinear feynman–kac formulas for viscosity solutions of semilinear parabolic partial differential equations. *Stochastics and Dynamics*, 21(08):2150048.
- Carlsson, G. and Brüel Gabriëlsson, R. (2018). Topological Approaches to Deep Learning. *arXiv e-prints*, page arXiv:1811.01122.
- Chollet, F. (2017). Xception: Deep learning with depthwise separable convolutions. In *2017 IEEE Conference on Computer Vision and Pattern Recognition (CVPR)*, pages 1800–1807, Los Alamitos, CA, USA. IEEE Computer Society.
- Crandall, M. G., Ishii, H., and Lions, P.-L. (1992). User’s guide to viscosity solutions of second order partial differential equations. *Bull. Amer. Math. Soc.*, 27(1):1–67.
- Cybenko, G. (1989). Approximation by superpositions of a sigmoidal function. *Mathematics of Control, Signals and Systems*, 2(4):303–314.
- Da Prato, G. and Zabczyk, J. (2002). *Second Order Partial Differential Equations in Hilbert Spaces*. London Mathematical Society Lecture Note Series. Cambridge University Press.
- Davies, A., Juh'asz, A., Lackenby, M., and Tomasev, N. (2021). The signature and cusp geometry of hyperbolic knots. *ArXiv*, abs/2111.15323.
- Durrett, R. (2019). *Probability: Theory and Examples*. Cambridge Series in Statistical and Probabilistic Mathematics. Cambridge University Press.

- E, W., Hutzenthaler, M., Jentzen, A., and Kruse, T. (2019). On Multilevel Picard Numerical Approximations for High-Dimensional Nonlinear Parabolic Partial Differential Equations and High-Dimensional Nonlinear Backward Stochastic Differential Equations. *J Sci Comput*, 79(3):1534--1571.
- E, W., Hutzenthaler, M., Jentzen, A., and Kruse, T. (2021). Multilevel Picard iterations for solving smooth semilinear parabolic heat equations. *Partial Differ. Equ. Appl.*, 2(6):80.
- Golub, G. and Van Loan, C. (2013). *Matrix Computations*. Johns Hopkins Studies in the Mathematical Sciences. Johns Hopkins University Press.
- Grohs, P., Hornung, F., Jentzen, A., and von Wurstemberger, P. (2018). A proof that artificial neural networks overcome the curse of dimensionality in the numerical approximation of Black-Scholes partial differential equations. Papers 1809.02362, arXiv.org.
- Grohs, P., Hornung, F., Jentzen, A., and Zimmermann, P. (2023). Space-time error estimates for deep neural network approximations for differential equations. *Advances in Computational Mathematics*, 49(1):4.
- Grohs, P., Jentzen, A., and Salimova, D. (2022). Deep neural network approximations for solutions of PDEs based on monte carlo algorithms. *Partial Differential Equations and Applications*, 3(4).
- Gyöngy, I. and Krylov, N. V. (1996). Existence of strong solutions for Itô's stochastic equations via approximations. *Probability Theory and Related Fields*, 105:143--158.
- Hornik, K. (1991). Approximation capabilities of multilayer feedforward networks. *Neural Networks*, 4:251--257.
- Hutzenthaler, M., Jentzen, A., Kruse, T., Anh Nguyen, T., and von Wurstemberger, P. (2020a). Overcoming the curse of dimensionality in the numerical approximation of semilinear parabolic partial differential equations. *Proceedings of the Royal Society A: Mathematical, Physical and Engineering Sciences*, 476(2244):20190630.
- Hutzenthaler, M., Jentzen, A., Kuckuck, B., and Padgett, J. L. (2021). Strong L^p -error analysis of nonlinear Monte Carlo approximations for high-dimensional semilinear partial differential equations. Technical Report arXiv:2110.08297, arXiv. arXiv:2110.08297 [cs, math] type: article.
- Hutzenthaler, M., Jentzen, A., and von Wurstemberger Wurstemberger (2020b). Overcoming the curse of dimensionality in the approximative pricing of financial derivatives with default risks. *Electronic Journal of Probability*, 25(none):1 -- 73.
- Itô, K. (1942a). Differential equations determining Markov processes (original in Japanese). *Zenkoku Shijo Sugaku Danwakai*, 244(1077):1352--1400.
- Itô, K. (1942b). On a stochastic integral equation. *Proc. Imperial Acad. Tokyo*, 244(1077):1352--1400.
- Jentzen, A., Kuckuck, B., and von Wurstemberger, P. (2023). Mathematical introduction to deep learning: Methods, implementations, and theory.
- Karatzas, I. and Shreve, S. (1991). *Brownian Motion and Stochastic Calculus*. Graduate Texts in Mathematics (113) (Book 113). Springer New York.

- Knoke, T. and Wick, T. (2021). Solving differential equations via artificial neural networks: Findings and failures in a model problem. *Examples and Counterexamples*, 1:100035.
- Lagaris, I., Likas, A., and Fotiadis, D. (1998). Artificial neural networks for solving ordinary and partial differential equations. *IEEE Transactions on Neural Networks*, 9(5):987–1000.
- McCulloch, W. S. and Pitts, W. (1943). A logical calculus of the ideas immanent in nervous activity. *The bulletin of mathematical biophysics*, 5(4):115–133.
- Petersen, P. and Voigtlaender, F. (2018). Optimal approximation of piecewise smooth functions using deep ReLU neural networks. *Neural Netw*, 108:296–330.
- Plotly Technologies Inc (2015). Collaborative data science.
- Rafi, S. (2024). nnR.
- Rafi, S. and Padgett, J. L. (2024). *nnR: Neural Networks Made Algebraic*. R package version 0.1.0.
- Rafi, S., Padgett, J. L., and Nakarmi, U. (2024). Towards an Algebraic Framework For Approximating Functions Using Neural Network Polynomials.
- Rio, E. (2009). Moment Inequalities for Sums of Dependent Random Variables under Projective Conditions. *J Theor Probab*, 22(1):146–163.
- Shiebler, D., Gavranović, B., and Wilson, P. (2021). Category theory in machine learning.
- Srivastava, N., Hinton, G., Krizhevsky, A., Sutskever, I., and Salakhutdinov, R. (2014). Dropout: a simple way to prevent neural networks from overfitting. *J. Mach. Learn. Res.*, 15(1):1929–1958.
- Strubell, E., Ganesh, A., and McCallum, A. (2019). Energy and policy considerations for deep learning in nlp.
- Tsaban, T., Varga, J. K., Avraham, O., Ben-Aharon, Z., Khramushin, A., and Schueler-Furman, O. (2022). Harnessing protein folding neural networks for peptide–protein docking. *Nat Commun*, 13(1):176. Number: 1 Publisher: Nature Publishing Group.
- Vaswani, A., Shazeer, N., Parmar, N., Uszkoreit, J., Jones, L., Gomez, A. N., Kaiser, L. u., and Polosukhin, I. (2017b). Attention is all you need. In Guyon, I., Luxburg, U. V., Bengio, S., Wallach, H., Fergus, R., Vishwanathan, S., and Garnett, R., editors, *Advances in Neural Information Processing Systems*, volume 30. Curran Associates, Inc.
- Vaswani, A., Shazeer, N., Parmar, N., Uszkoreit, J., Jones, L., Gomez, A. N., Kaiser, î, and Polosukhin, I. (2017a). Attention is All you Need. In *Advances in Neural Information Processing Systems*, volume 30. Curran Associates, Inc.
- Wickham, H. (2016). *ggplot2: Elegant Graphics for Data Analysis*. Springer-Verlag New York.
- Wickham, H., François, R., Henry, L., Müller, K., and Vaughan, D. (2023). *dplyr: A Grammar of Data Manipulation*. R package version 1.1.4, <https://github.com/tidyverse/dplyr>.
- Wu, C.-J., Raghavendra, R., Gupta, U., Acun, B., Ardalani, N., Maeng, K., Chang, G., Behram, F. A., Huang, J., Bai, C., Gschwind, M., Gupta, A., Ott, M., Melnikov, A., Candido, S., Brooks, D., Chauhan, G., Lee, B., Lee, H.-H. S., Akyildiz, B., Balandat, M., Spisak, J., Jain, R., Rabbat, M., and Hazelwood, K. (2022). Sustainable ai: Environmental implications, challenges and opportunities.

Zhao, T., Lyu, R., Wang, H., Cao, Z., and Ren, Z. (2023). Space-based gravitational wave signal detection and extraction with deep neural network. *Commun Phys*, 6(1):1--12. Number: 1
Publisher: Nature Publishing Group.

10.2 Code Listings

Parts of this code have been released on CRAN under the package name `nnR`, and can be found in Rafi and Padgett (2024), with the corresponding repository being found at Rafi (2024):

Listing 10.1: R code for neural network generation

```
1 #' Function to generate a random matrix with specified dimensions.
2 #'
3 #' @param rows number of rows.
4 #' @param cols number of columns.
5 #'
6 #' @return a random matrix of dimension rows times columns with elements from
7 #' a standard normal distribution
8
9 generate_random_matrix <- function(rows, cols) {
10   (rows * cols) |>
11     rnorm() |>
12     matrix(rows, cols) -> result
13   return(result)
14 }
15
16 #' @title create_neural_network
17 #' @description Function to create a list of lists for neural network layers
18 #'
19 #' @param layer_architecture a list specifying the width of each layer
20 #'
21 #' @return An ordered list of ordered pairs of  $\{W, b\}$ . Where  $W$  is the
22 #' matrix
23 #' representing the weight matrix at that layer and  $b$  the bias vector. Entries
24 #' on the matrix come from a standard normal distribution. Neural networks
25 #' are defined to be elements belonging to the following set:
26 #'
27 #' 
$$\mathbb{NN} = \bigcup_{L \in \mathbb{N}} \bigcup_{l_0, l_1, \dots, l_L \in \mathbb{N}} \left( \times_{k=1}^L \left[ \mathbb{R}^{l_k \times l_{k-1}} \times \mathbb{R}^{l_k} \right] \right)$$

28 #'
29 #'
30 #'
31 #' }
32 #'
33 #'
34 #'
35 #'
36 #' We will use the definition of neural networks as found in:
37 #'
38 #' @references Grohs, P., Hornung, F., Jentzen, A. et al.
39 #' Space-time error estimates for deep neural network approximations
40 #' for differential equations. Adv Comput Math 49, 4 (2023).
41 #' \url{https://doi.org/10.1007/s10444-022-09970-2}.
42 #' @export
43
44 create_neural_network <- function(layer_architecture) {
45   if (all(sapply(layer_architecture, function(x) is.numeric(x) && x %% 1 == 0 && x >
46     0)) == FALSE) {
47     stop("Non_integer_or_negative_neural_network_width_specified.")
48   } else if (length(layer_architecture) < 2) {
49     stop("Neural_network_must_have_atleast_two_layers.")
50   } else {
```

```

50 layer_architecture |> length() -> L
51
52 # Initialize the list of lists
53 neural_network <- list()
54
55 # Generate matrices W and vectors b for each layer
56 for (i in 1:(L - 1)) {
57   # Set dimensions for W and b
58   layer_architecture[i] -> input_size
59   layer_architecture[i + 1] -> output_size
60
61   # Create matrix W
62   generate_random_matrix(output_size, input_size) -> W
63
64   # Create vector b
65   output_size |>
66   rnorm() |>
67   matrix(output_size, 1) -> b
68
69   # Add W and b to the list
70   list(W = W, b = b) -> neural_network[[i]]
71 }
72
73 return(neural_network)
74 }
75 }

```

Listing 10.2: R code for auxilliary functions

```

1 source("R/is_nn.R")
2 #' @title hid
3 #'
4 #' @description The function that returns the number of hidden layers of a
5 #' neural network. Denoted  $\mathsf{H}$ 
6 #'
7 #' @param nu a neural network of the type generated by create_neural_network()
8 #'
9 #' By definition  $\mathsf{H}(\mathsf{nu}) = \mathsf{D}(\mathsf{nu}) - 1$ 
10 #'
11 #' @references Definition 1.3.1. Jentzen, A., Kuckuck, B., and von Wurstemberger, P.
12 #' (2023).
13 #' Mathematical introduction to deep learning: Methods, implementations,
14 #' and theory. \url{https://arxiv.org/abs/2310.20360}.
15 #'
16 #' @return Integer representing the number of hidden layers.
17 #' @export
18
19 hid <- function(nu) {
20   if (nu |> is_nn() == TRUE) {
21     return(length(nu) - 1)
22   } else {
23     stop("Only_neural_networks_can_have_hidden_layers")
24   }
25 }
26
27 #' @title dep
28 #' @description The function that returns the depth of a neural network. Denoted
29 #'  $\mathsf{D}$ .
30 #'

```

```

30 #' @param nu a neural network of the type generated by
31 #' create_neural_network(). Very straightforwardly it is the
32 #' length of the list where neural networks are defined as an ordered list of
33 #' lists.
34 #' @references Definition 1.3.1. Jentzen, A., Kuckuck, B., and von Wurstemberger, P.
35 #' (2023).
36 #' Mathematical introduction to deep learning: Methods, implementations,
37 #' and theory. \url{https://arxiv.org/abs/2310.20360}.
38 #'
39 #' @return Integer representing the depth of the neural network.
40 #' @export
41
42 dep <- function(nu) {
43   if (nu |> is_nn() == TRUE) {
44     return(length(nu))
45   } else {
46     stop("Only_neural_networks_can_have_depth")
47   }
48 }
49
50 #' @title inn
51 #' @description The function that returns the input layer size of a neural
52 #' network. Denoted  $\mathsf{I}$ 
53 #'
54 #' @param nu A neural network of the type generated by
55 #' create_neural_network().
56 #'
57 #' @references Definition 1.3.1. Jentzen, A., Kuckuck, B., and von Wurstemberger, P.
58 #' (2023).
59 #' Mathematical introduction to deep learning: Methods, implementations,
60 #' and theory. \url{https://arxiv.org/abs/2310.20360}.
61 #'
62 #' @return An integer representing the input width of the neural network.
63 #' @export
64
65 inn <- function(nu) {
66   if (nu |> is_nn() == TRUE) {
67     return(dim(nu[[1]]$W)[2])
68   } else {
69     stop("Only_neural_networks_can_have_size_of_input_layers")
70   }
71 }
72
73 #' @title out
74 #' @description The function that returns the output layer size of a neural
75 #' network. Denoted  $\mathsf{O}$ .
76 #'
77 #' @param nu A neural network of the type generated by create_neural_network().
78 #'
79 #' @references Definition 1.3.1. Jentzen, A., Kuckuck, B., and von Wurstemberger, P.
80 #' (2023).
81 #' Mathematical introduction to deep learning: Methods, implementations,
82 #' and theory. \url{https://arxiv.org/abs/2310.20360}.
83 #'
84 #' @return An integer representing the output width of the neural network.
85 #' @export
86
87 out <- function(nu) {

```

```

86   if (nu |> is_nn() == TRUE) {
87     return(dim(nu[[length(nu)]]$W)[1])
88   } else {
89     stop("Only_neural_networks_can_have_size_of_output_layers")
90   }
91 }
92
93
94 #' @title lay
95 #' @description The function that returns the layer architecture of a neural
96 #' network.
97 #'
98 #' @param nu A neural network of the type generated by
99 #' create_neural_network(). Denoted  $\{L\}$ .
100 #'
101 #' @references Definition 1.3.1. Jentzen, A., Kuckuck, B., and von Wurstemberger, P.
102 #' (2023).
103 #' Mathematical introduction to deep learning: Methods, implementations,
104 #' and theory. \url{https://arxiv.org/abs/2310.20360}.
105 #'
106 #' @return A tuple representing the layer architecture of our neural network.
107 #' @export
108
109 lay <- function(nu) {
110   if (nu |> is_nn() == TRUE) {
111     layer_architecture <- list()
112     for (i in 1:length(nu)) {
113       layer_architecture |> append(dim(nu[[i]]$W)[1]) -> layer_architecture
114     }
115     inn(nu) |> append(layer_architecture) -> layer_architecture
116     return(layer_architecture)
117   } else {
118     stop("Only_neural_networks_can_have_layer_architectures")
119   }
120 }
121
122 #' @title param
123 #' @description The function that returns the numbe of parameters of a neural
124 #' network.
125 #'
126 #' @param nu A neural network of the type generated by
127 #' create_neural_network(). Denoted  $\{P\}$ .
128 #'
129 #' @references Definition 1.3.1. Jentzen, A., Kuckuck, B., and von Wurstemberger, P.
130 #' (2023).
131 #' Mathematical introduction to deep learning: Methods, implementations,
132 #' and theory. \url{https://arxiv.org/abs/2310.20360}.
133 #'
134 #' @return An integer representing the parameter count of our neural network.
135 #' @export
136
137 param <- function(nu) {
138   if (nu |> is_nn() == TRUE) {
139     0 -> param_count
140     for (i in 1:length(nu)) {
141       param_count + length(nu[[i]]$W) + length(nu[[i]]$b) -> param_count
142     }
143   }
144   return(param_count)

```

```

143 } else {
144   stop("Only_neural_networks_can_have_parameters")
145 }
146 }

```

Listing 10.3: R code for activation functions ReLU and Sigmoid

```

1 #' @title: ReLU
2 #' @description: The ReLU activation function
3 #'
4 #' @param x A real number that is the input to our ReLU function.
5 #'
6 #' @return The output of the standard ReLU function, i.e.  $\max\{0, x\}$ . See also
7 #' \code{\link{Sigmoid}}.
8 #' and \code{\link{Tanh}}.
9 #' @export
10
11 ReLU <- function(x) {
12   if (x > is.numeric() && x > length() == 1 && x > is.finite()) {
13     return(x > max(0))
14   } else {
15     stop("x_must_be_a_real_number")
16   }
17 }
18
19 #' @title: Sigmoid
20 #' @description The Sigmoid activation function.
21 #'
22 #' @param x a real number that is the input to our Sigmoid function
23 #'
24 #' @return The output of a standard Sigmoid function,
25 #' i.e.  $\frac{1}{1 + \exp(-x)}$ .
26 #' See also \code{\link{Tanh}}.and \code{\link{ReLU}}.
27 #' @export
28
29 Sigmoid <- function(x) {
30   if (x > is.numeric() && x > length() == 1 && x > is.finite()) {
31     return(1 / (1 + exp(-x)))
32   } else {
33     stop("x_must_be_a_real_number")
34   }
35 }
36
37 #' @title Tanh
38 #' @description The tanh activation function
39 #'
40 #' @param x a real number
41 #'
42 #' @return the  $\tanh$  of x. See also \code{\link{Sigmoid}} and
43 #' \code{\link{ReLU}}.
44 #' @export
45
46 Tanh <- function(x) {
47   if (x > is.numeric() && x > length() == 1 && x > is.finite()) {
48     return(x > tanh())
49   } else {
50     stop("x_must_be_a_real_number")
51   }
52 }

```

Listing 10.4: R code for realizations

```

1 source("R/aux_fun.R")
2 source("R/is_nn.R")
3
4 #' @title inst
5 #' @description The function that instantiates a neural network as created
6 #' by create_neural_network().
7 #'
8 #'
9 #' @param neural_network An ordered list of lists, of the type generated by
10 #' create_neural_network() where each element in the
11 #' list of lists is a pair  $\{W, b\}$  representing the weights and biases of
12 #' that layer.
13 #'
14 #' \emph{NOTE:} We will call instantiation what Grohs et. al. call "realization".
15 #'
16 #' @references Grohs, P., Hornung, F., Jentzen, A. et al. Space-time error estimates
17 #' for deep
18 #' neural network approximations for differential equations. Adv Comput Math 49, 4
19 #' (2023).
20 #' https://doi.org/10.1007/s10444-022-09970-2.
21 #'
22 #' Definition 1.3.4. Jentzen, A., Kuckuck, B., and von Wurstemberger, P. (2023).
23 #' Mathematical introduction to deep learning: Methods, implementations,
24 #' and theory. \url{https://arxiv.org/abs/2310.20360}
25 #'
26 #' @param activation_function A continuous function applied to the output of each
27 #' layer
28 #' @param x our input to the continuous function formed from activation. Our input
29 #' will
30 #' be an element in  $\mathbb{R}^d$  for some appropriate  $d$ .
31 #'
32 #' @return The output of the function that is the instantiation of the given
33 #' neural network with the given activation function at the given  $x$ .
34 #'
35 #' @export
36 #'
37
38 inst <- function(neural_network, activation_function, x) {
39   if (neural_network |> is_nn() == FALSE) {
40     stop("Only_neural_networks_can_be_instantiated")
41   } else if (neural_network |> inn() != x |>
42     matrix() |>
43     nrow()) {
44     stop("x_does_not_match_input_size_required_by_neural_network")
45   } else {
46     if (dep(neural_network) == 1) {
47       neural_network[[1]]$W %*% x + neural_network[[1]]$b -> output
48       return(output)
49     }
50     x |> matrix() -> output
51     for (i in 1:(length(neural_network) - 1)) {
52       neural_network[[i]]$W %*% output + neural_network[[i]]$b -> linear_transform

```

```

52     apply(linear_transform,
53           MARGIN = 1,
54           FUN = activation_function
55           ) -> output
56   }
57   neural_network[[length(neural_network)]]$W %*% output +
58   neural_network[[length(neural_network)]]$b -> output
59   return(output)
60 }
61 }

```

Listing 10.5: R code for parallelizing two neural networks

```

1 source("R/aux_fun.R")
2 source("R/Tun.R")
3 source("R/is_nn.R")
4
5
6 #' Function for creating a block diagonal given two matrices.
7 #'
8 #' @param matrix1 A matrix.
9 #' @param matrix2 A matrix
10 #'
11 #' @return A block diagonal matrix with matrix1 on top left
12 #' and matrix2 on bottom right.
13
14 create_block_diagonal <- function(matrix1, matrix2) {
15   nrow(matrix1) -> m1
16   nrow(matrix2) -> m2
17   ncol(matrix1) -> n1
18   ncol(matrix2) -> n2
19
20   # Create a block diagonal matrix
21   0 |> matrix(m1 + m2, n1 + n2) -> block_diagonal_matrix
22   block_diagonal_matrix[1:m1, 1:n1] <- matrix1
23   block_diagonal_matrix[(m1 + 1):(m1 + m2), (n1 + 1):(n1 + n2)] <-
24     matrix2
25
26   return(block_diagonal_matrix)
27 }
28
29 #' @title stk
30 #' @description A function that stacks neural networks.
31 #'
32 #' @param nu neural network.
33 #' @param mu neural network.
34 #'
35 #' @return A stacked neural network of  $\nu$  and  $\mu$ , i.e.  $\nu \boxminus \mu$ 
36 #'
37 #'
38 #' \strong{NOTE:} This is different than the one given in Grohs, et. al. 2023.
39 #' While we use padding to equalize neural networks being parallelized our
40 #' padding is via the Tun network whereas Grohs et. al. uses repetitive
41 #' composition of the i network. We use repetitive composition of the  $\mathsf{Id}_1$ 
42 #' network. See \link{Id} \link{comp}
43 #'
44 #' \strong{NOTE:} The terminology is also different from Grohs et. al. 2023.

```



```

45 #' We call stacking what they call parallelization. This terminology change was
46 #' inspired by the fact that parallelization implies commutativity but this
47 #' operation is not quite commutative. It is commutative up to transposition
48 #' of our input x under instantiation with a continuous activation function.
49 #'
50 #' Also the work parallelization has a lot of baggage when it comes to
51 #' artificial neural networks in that it often means many different CPUs working
52 #' together.
53 #'
54 #' \emph{Remark:} We will use only one symbol for stacking equal and unequal depth
55 #' neural networks, namely "stk". This is for usability but also that
56 #' for all practical purposes only the general stacking of neural networks
57 #' of different sizes is what is needed.
58 #'
59 #' \emph{Remark:} We have two versions, a prefix and an infix version.
60 #'
61 #' This operation on neural networks, called "parallelization" is found in:
62 #' @references Grohs, P., Hornung, F., Jentzen, A. et al. Space-time error estimates
63 #' for deep
64 #' neural network approximations for differential equations. Adv Comput Math 49, 4
65 #' (2023).
66 #' https://doi.org/10.1007/s10444-022-09970-2
67 #'
68 #' @export
69
70 stk <- function(nu, mu) {
71   if (nu |> is_nn() && mu |> is_nn()) {
72     if (dep(nu) == dep(mu)) {
73       list() -> parallelized_network
74       for (i in 1:length(nu)) {
75         create_block_diagonal(nu[[i]]$W, mu[[i]]$W) -> parallelized_W
76         rbind(nu[[i]]$b, mu[[i]]$b) -> parallelized_b
77         list(W = parallelized_W, b = parallelized_b) -> parallelized_network[[i]]
78       }
79       return(parallelized_network)
80     }
81     if (dep(nu) > dep(mu)) {
82       (dep(nu) - dep(mu) + 1) |> Tun(d = out(mu)) -> padding
83       padding |> comp(mu) -> padded_network
84       nu |> stk(padded_network) -> parallelized_network
85       return(parallelized_network)
86     }
87     if (dep(nu) < dep(mu)) {
88       (dep(mu) - dep(nu) + 1) |> Tun(d = out(nu)) -> padding
89       padding |> comp(nu) -> padded_network
90       padded_network |> stk(mu) -> parallelized_network
91       return(parallelized_network)
92     }
93   } else {
94     stop("Please_try_stacking_neural_networks")
95   }
96 }
97
98 #' The stk function.
99 #'
100 #' @param nu neural network.
101 #' @param mu neural network.

```

```

102 #'
103 #' @return A stacked neural network of nu and mu.
104 #' @export
105
106
107 `%stk%` <- function(nu, mu) {
108   if (nu |> is_nn() && mu |> is_nn()) {
109     if (dep(nu) == dep(mu)) {
110       list() -> parallelized_network
111       for (i in 1:length(nu)) {
112         create_block_diagonal(nu[[i]]$W, mu[[i]]$W) -> parallelized_W
113         rbind(nu[[i]]$b, mu[[i]]$b) -> parallelized_b
114         list(W = parallelized_W, b = parallelized_b) -> parallelized_network[[i]]
115       }
116       return(parallelized_network)
117     }
118
119     if (dep(nu) > dep(mu)) {
120       (dep(nu) - dep(mu) + 1) |> Tun(d = out(mu)) -> padding
121       padding |> comp(mu) -> padded_network
122       nu |> stk(padded_network) -> parallelized_network
123       return(parallelized_network)
124     }
125
126     if (dep(nu) < dep(mu)) {
127       (dep(mu) - dep(nu) + 1) |> Tun(d = out(nu)) -> padding
128       padding |> comp(nu) -> padded_network
129       padded_network |> stk(mu) -> parallelized_network
130       return(parallelized_network)
131     }
132   } else {
133     stop("Please_try_stacking_neural_networks")
134   }
135 }

```

Listing 10.6: R code for affine neural networks

```

1 #' @title Aff
2 #' @description The function that returns  $\text{Aff}$  neural networks.
3 #'
4 #' @param W An  $m \times n$  matrix representing the weight of the affine
5 #' neural network
6 #' @param b An  $m \times 1$  vector representing the bias of the affine
7 #' neural network
8 #'
9 #' @references Grohs, P., Hornung, F., Jentzen, A. et al. Space-time error estimates
10 #' for deep
11 #' neural network approximations for differential equations. Adv Comput Math 49, 4
12 #' (2023).
13 #' https://doi.org/10.1007/s10444-022-09970-2
14 #'
15 #' Definition 2.3.1. Jentzen, A., Kuckuck, B., and von Wursterberger, P. (2023).
16 #' Mathematical introduction to deep learning: Methods, implementations,
17 #' and theory. url{https://arxiv.org/abs/2310.20360}
18 #'
19 #' @return Returns the network  $((W,b))$  representing an affine neural network.
20 #' Also
21 #' denoted as  $\text{Aff}_{W,b}$ 
22 #' See also \link{Cpy} and \link{Sum}.

```

```

20 #' @export
21
22 Aff <- function(W, b) {
23   if (W |> is.matrix()) == FALSE (W |> matrix() -> W)
24   if (b |> is.matrix()) == FALSE (b |> matrix() -> b)
25   list(list(W = W, b = b)) -> return_network
26   return(return_network)
27 }
28
29 #' @title Cpy
30 #' @description The function that returns  $\text{eqn}\{\mathsf{Cpy}\}$  neural networks.
31 #' These are neural networks defined as such
32 #' \deqn{
33 #' \mathsf{Aff}_{\left[ \mathbb{I}_k \ : \ \mathbb{I}_k \ : \ \cdots \ : \ \mathbb{I}_k \right]^T, 0_{k}}
34 #' }
35 #'
36 #' @param n number of copies to make.
37 #' @param k the size of the input vector.
38 #'
39 #' @return Returns an affine network that makes a concatenated vector that is  $\text{eqn}\{n\}$ 
40 #' copies of the input vector of size  $\text{eqn}\{k\}$ . See \link{Aff} and \link{Sum}.
41 #'
42 #' @references Definition 2.4.6. Jentzen, A., Kuckuck, B., and von Wurstemberger, P.
43 #' (2023).
44 #' Mathematical introduction to deep learning: Methods, implementations,
45 #' and theory. \url{https://arxiv.org/abs/2310.20360}
46 #'
47 #' @export
48
49 Cpy <- function(n, k) {
50   if (n %% 1 != 0 ||
51       n < 1 ||
52       k %% 1 != 0 ||
53       k < 1) {
54     stop("n_and_k_must_be_natural_numbers")
55   } else {
56     k |> diag() -> W
57     for (i in 2:n) {
58       W |> rbind(k |> diag()) -> W
59     }
60     0 |> matrix(n * k) -> b
61     list(list(W = W, b = b)) -> return_network
62     return(return_network)
63   }
64 }
65
66 #' @title Sum
67 #' @description The function that returns  $\text{eqn}\{\mathsf{Sum}\}$  neural networks.
68 #'
69 #' These are neural networks defined as such
70 #' \deqn{
71 #' \mathsf{Aff}_{\left[ \mathbb{I}_k \ : \ \mathbb{I}_k \ : \ \cdots \ : \ \mathbb{I}_k \right], 0_{k}}
72 #' }
73 #'
74 #' @param n number of copies of a certain vector to be summed.

```

```

75 #' @param k the size of the summation vector.
76 #'
77 #' @return An affine neural network that will take a vector of size
78 #'  $\{n \times k\}$  and return the summation vector that is of length
79 #'  $\{k\}$ . See also \link{Aff} and \link{Cpy}.
80 #'
81 #' @references Definition 2.4.1. Jentzen, A., Kuckuck, B., and von Wurstemberger, P.
82 #' (2023).
83 #' Mathematical introduction to deep learning: Methods, implementations,
84 #' and theory. \url{https://arxiv.org/abs/2310.20360}
85 #'
86 #' @export
87 #'
88
89
90 Sum <- function(n, k) {
91   if (n %% 1 != 0 ||
92       n < 1 ||
93       k %% 1 != 0 ||
94       k < 1) {
95     stop("n_and_k_must_be_natural_numbers")
96   } else {
97     k |> diag() -> W
98     for (i in 2:n) {
99       W |> cbind(k |> diag()) -> W
100    }
101    0 |> matrix(k) -> b
102    list(list(W = W, b = b)) -> return_network
103
104    return(return_network)
105  }
106 }

```

Listing 10.7: R code for composition of two neural networks

```

1 source("R/aux_fun.R")
2 source("R/is_nn.R")
3
4
5 #' @title comp
6 #' @description The function that takes the composition of two neural
7 #' networks assuming they are compatible, i.e., given
8 #'  $\{\nu_1, \nu_2 \in \mathsf{NN}\}$ , it must be the case that
9 #'  $\{\mathsf{I}(\nu)_1 = \mathsf{0}(\nu_2)\}$ .
10 #'
11 #' @param phi_1 first neural network to be composed, goes on the left
12 #' @param phi_2 second neural network to be composed, goes on right
13 #'
14 #' @return The composed neural network. See also \link{dep}.
15 #' Composition of neural networks is the operation defined for  $\{\nu_1 \in \mathsf{NN}\}$ 
16 #' and  $\{\nu_2 \in \mathsf{NN}\}$  as:
17 #'
18 #' \deqn{
19 #'  $\nu_1 \bullet \nu_2 = \begin{cases} (W'_1, b'_1), \\
20 #' (W'_2, b'_2), \dots, (W'_{M-1}, b'_{M-1}), (W'_1 W'_M, W'_1 b'_M + b_1), (W_2, b_2) \\$ 

```

```

21 #' ( W_L,b_L )) & :( L > 1 ) \land ( M > 1 ) \\\((W_1W'_1,W_1b'_1+b_1),(W_2,b_2), (W_3,b
22 #' (W_Lb_L)) & :(L>1) \land (M=1) \\\((W'_1, b'_1),(W'_2,b'_2), ...,
23 #' (W'_{M-1}, b'_{M-1})(W_1, b'_M + b_1)) &:(L=1) \land (M>1) \\\ ((W_1W'_1, W_1b'_1+b_
24 #' \land (M=1)\end{cases}
25 #'
26
27 #' }
28 #'
29 #'
30 #' @references Grohs, P., Hornung, F., Jentzen, A. et al.
31 #' Space-time error estimates for deep neural network approximations
32 #' for differential equations. Adv Comput Math 49, 4 (2023).
33 #' \url{https://doi.org/10.1007/s10444-022-09970-2}.
34 #'
35 #' @references Definition 2.1.1. Jentzen, A., Kuckuck, B., and von Wurstemberger, P.
36 #' (2023).
37 #' Mathematical introduction to deep learning: Methods, implementations,
38 #' and theory. \url{https://arxiv.org/abs/2310.20360}
39 #'
40 #' \emph{Remark:} We have two versions of this function, an
41 #' infix version for close resemblance to mathematical notation and
42 #' prefix version.
43
44 #' @encoding utf8
45 #' @export
46 #'
47
48 comp <- function(phi_1, phi_2) {
49   if (phi_1 |> is_nn() && phi_2 |> is_nn()) {
50     dep(phi_1) -> L
51     dep(phi_2) -> L_
52
53     if (L > 1 & L_ > 1) {
54       phi_2[-L_] -> beginning
55       phi_1[-1] -> end
56       phi_1[[1]]$W %*% phi_2[[L_]]$W -> mid_W
57       phi_1[[1]]$W %*% phi_2[[L_]]$b + phi_1[[1]]$b -> mid_b
58       list(W = mid_W, b = mid_b) -> mid
59       c(
60         beginning,
61         list(mid),
62         end
63       ) -> composed_network
64       return(composed_network)
65     } else if (L > 1 & L_ == 1) {
66       phi_1[[1]]$W %*% phi_2[[1]]$W -> beginning_W
67       phi_1[[1]]$W %*% phi_2[[1]]$b + phi_1[[1]]$b -> beginning_b
68       list(
69         W = beginning_W,
70         b = beginning_b
71       ) -> beginning
72       phi_1[-1] -> end
73       c(
74         list(beginning),
75         end

```

```

76     ) -> composed_network
77     return(composed_network)
78   } else if (L == 1 & L_ > 1) {
79     phi_2[-L_] -> beginning
80     phi_1[[1]]$W %*% phi_2[[L_]]$W -> end_W
81     phi_1[[1]]$W %*% phi_2[[L_]]$b + phi_1[[1]]$b -> end_b
82     list(
83       W = end_W,
84       b = end_b
85     ) -> end
86     c(
87       beginning,
88       list(end)
89     ) -> composed_network
90     return(composed_network)
91   } else if (L == 1 & L_ == 1) {
92     list() -> composed_network
93     phi_1[[1]]$W %*% phi_2[[1]]$W -> W
94     phi_1[[1]]$W %*% phi_2[[1]]$b + phi_1[[1]]$b -> b
95     list(
96       W = W,
97       b = b
98     ) -> composed_network[[1]]
99     return(composed_network)
100  } else {
101    stop("Dimensionality_mismatch")
102  }
103 } else {
104   stop("Only_neural_networks_can_be_composed.")
105 }
106 }
107
108 #' The `infix version of comp function
109 #'
110 #' @param phi_1 first neural network to be composed, goes on the left
111 #' @param phi_2 second neural network to be composed, goes on right
112 #'
113 #' @rdname comp
114 #' @export
115
116
117 `%comp%` <- function(phi_1, phi_2) {
118   if (phi_1 |> is_nn() && phi_2 |> is_nn()) {
119     dep(phi_1) -> L
120     dep(phi_2) -> L_
121
122     if (L > 1 & L_ > 1) {
123       phi_2[-L_] -> beginning
124       phi_1[-1] -> end
125       phi_1[[1]]$W %*% phi_2[[L_]]$W -> mid_W
126       phi_1[[1]]$W %*% phi_2[[L_]]$b + phi_1[[1]]$b -> mid_b
127       list(W = mid_W, b = mid_b) -> mid
128       c(
129         beginning,
130         list(mid),
131         end
132       ) -> composed_network
133       return(composed_network)

```

```

134 } else if (L > 1 & L_ == 1) {
135   phi_1[[1]]$W %*% phi_2[[1]]$W -> beginning_W
136   phi_1[[1]]$W %*% phi_2[[1]]$b + phi_1[[1]]$b -> beginning_b
137   list(
138     W = beginning_W,
139     b = beginning_b
140   ) -> beginning
141   phi_1[-1] -> end
142   c(
143     list(beginning),
144     end
145   ) -> composed_network
146   return(composed_network)
147 } else if (L == 1 & L_ > 1) {
148   phi_2[-L_] -> beginning
149   phi_1[[1]]$W %*% phi_2[[L_]]$W -> end_W
150   phi_1[[1]]$W %*% phi_2[[L_]]$b + phi_1[[1]]$b -> end_b
151   list(
152     W = end_W,
153     b = end_b
154   ) -> end
155   c(
156     beginning,
157     list(end)
158   ) -> composed_network
159   return(composed_network)
160 } else if (L == 1 & L_ == 1) {
161   list() -> composed_network
162   phi_1[[1]]$W %*% phi_2[[1]]$W -> W
163   phi_1[[1]]$W %*% phi_2[[1]]$b + phi_1[[1]]$b -> b
164   list(
165     W = W,
166     b = b
167   ) -> composed_network[[1]]
168   return(composed_network)
169 } else {
170   stop("Dimensionality_mismatch")
171 }
172 } else {
173   stop("Only_neural_networks_can_be_composed.")
174 }
175 }

```

Listing 10.8: R code for scalar multiplication

```

1 source("R/comp.R")
2 source("R/aux_fun.R")
3 source("R/is_nn.R")
4
5 #' @title slm
6 #'
7 #' @description The function that returns the left scalar multiplication
8 #' neural network
9 #'
10 #' @param a A real number.
11 #' @param nu A neural network of the kind created by create_neural_network.
12 #'
13 #' @return Returns a neural network that is  $\text{eqn}\{a \text{ \texttrianglerightright \nu}\}$ . This

```

```

14 #' instantiates as  $f(a \cdot x)$  under continuous function activation. More
    #' specifically
15 #' we define operation as:
16 #'
17 #' Let  $\lambda \in \mathbb{R}$ . We will denote by  $(\cdot) \triangleright$ 
    #'  $(\cdot)$ :
18 #'  $\mathbb{R} \times \mathbb{N} \rightarrow \mathbb{N}$  the function satisfying for
    #' all
19 #'  $\nu \in \mathbb{N}$  and  $\lambda \in \mathbb{R}$  that  $\lambda \triangleright \nu =$ 
    #'  $\text{Aff}_{\{\lambda \mathbb{I}_{\mathbb{N}}\}, 0}$ .
20 #'
21
22 #' @references Definition 2.3.4. Jentzen, A., Kuckuck, B., and von Wurstemberger, P.
    #' (2023).
23 #' Mathematical introduction to deep learning: Methods, implementations,
24 #' and theory. url{https://arxiv.org/abs/2310.20360}.
25 #'
26 #' \emph{Note:} We will have two versions of this operation, a prefix and an
27 #' infix version.
28 #' @export
29
30
31 slm <- function(a, nu) {
32   if (a |> is.numeric() &&
33       length(a) == 1 &&
34       a |> is.finite() &&
35       nu |> is_nn()) {
36     nu |> out() -> constant_matrix_size
37     list() -> multiplier_network
38     a |> diag(constant_matrix_size) -> W
39     0 |> matrix(constant_matrix_size) -> b
40     list(W = W, b = b) -> multiplier_network[[1]]
41     multiplier_network |> comp(nu) -> return_network
42     return(return_network)
43   } else {
44     stop("a_must_be_a_real_number_and_nu_must_be_a_neural_network")
45   }
46 }
47
48 #' @title srm
49 #' @description The function that returns the right scalar multiplication
50 #' neural network
51 #'
52 #' @param nu A neural network of the type generated by create_neural_network().
53 #' @param a A real number.
54 #'
55 #' @return Returns a neural network that is  $\nu \triangleleft a$ . This
56 #' instantiates as  $f(a \cdot x)$  under continuous function activation. More
57 #' specifically we will define this operation as:
58 #'
59 #' Let  $\lambda \in \mathbb{R}$ . We will denote by  $(\cdot) \triangleleft$ 
    #'  $(\cdot)$ :
60 #'  $\mathbb{N} \times \mathbb{R} \rightarrow \mathbb{N}$  the function satisfying for
    #' all
61 #'  $\nu \in \mathbb{N}$  and  $\lambda \in \mathbb{R}$  that  $\nu \triangleleft \lambda =$ 
    #'  $\text{Aff}_{\{\lambda \mathbb{I}_{\mathbb{N}}\}, 0}$ .
62 #'
63 #'
64 #' @references Definition 2.3.4. Jentzen, A., Kuckuck, B., and von Wurstemberger, P.

```



```

(2023).
65 #' Mathematical introduction to deep learning: Methods, implementations,
66 #' and theory. \url{https://arxiv.org/abs/2310.20360}.
67 #'
68 #' \emph{Note:} We will have two versions of this operation, a prefix
69 #' and an infix version.
70 #' @export
71
72 srm <- function(nu, a) {
73   if (a |> is.numeric() &&
74       length(a) == 1 &&
75       a |> is.finite() &&
76       nu |> is_nn()) {
77     nu |> inn() -> constant_matrix_size
78     list() -> multiplier_network
79     a |> diag(constant_matrix_size) -> W
80     0 |> matrix(constant_matrix_size) -> b
81     list(W = W, b = b) -> multiplier_network[[1]]
82     nu |> comp(multiplier_network) -> return_network
83     return(return_network)
84   } else {
85     stop("a_must_be_a_real_number_and_nu_must_be_a_neural_network")
86   }
87 }
88
89
90 #'
91 #' @param a A real number.
92 #' @param nu A neural network of the type generated by create_neural_network().
93 #'
94 #' @rdname slm
95 #' @export
96
97 `%slm%` <- function(a, nu) {
98   if (a |> is.numeric() &&
99       length(a) == 1 &&
100      a |> is.finite() &&
101      nu |> is_nn()) {
102     nu |> out() -> constant_matrix_size
103     list() -> multiplier_network
104     a |> diag(constant_matrix_size) -> W
105     0 |> matrix(constant_matrix_size) -> b
106     list(W = W, b = b) -> multiplier_network[[1]]
107     multiplier_network |> comp(nu) -> return_network
108     return(return_network)
109   } else {
110     stop("a_must_be_a_real_number_and_nu_must_be_a_neural_network")
111   }
112 }
113
114 #' @param nu A neural network
115 #' @param a A real number.
116 #'
117 #' @rdname srm
118 #' @export
119
120 `%srm%` <- function(nu, a) {
121   if (a |> is.numeric() &&

```

```

122     length(a) == 1 &&
123     a |> is.finite() &&
124     nu |> is_nn()) {
125     nu |> inn() -> constant_matrix_size
126     list() -> multiplier_network
127     a |> diag(constant_matrix_size) -> W
128     0 |> matrix(constant_matrix_size) -> b
129     list(W = W, b = b) -> multiplier_network[[1]]
130     nu |> comp(multiplier_network) -> return_network
131     return(return_network)
132   } else {
133     stop("a_must_be_a_real_number_and_nu_must_be_a_neural_network")
134   }
135 }

```

Listing 10.9: R code for sum of two neural networks

```

1 source("R/comp.R")
2 source("R/stacking.R")
3 source("R/aux_fun.R")
4 source("R/Aff.R")
5 source("R/is_nn.R")
6
7 #' @title nn_sum
8 #' @description A function that performs the neural network sum for two
9 #' neural networks of the type generated by
10 #' create_neural_network(). Neural network sums are defined for
11 #'  $\nu_1 \in \mathbb{NN}$  and  $\nu_2 \in \mathbb{NN}$  as:
12 #' 
$$\nu_1 \oplus \nu_2 = \left( \sum_{v=u+1}^{\nu_2} 0 \right) \bullet \left[ \boxminus_{i=u}^{\nu_1} \right] \bullet \text{Cpy}_{(v-u+1), I}(\nu_1)$$

13 #' }
14 #'
15 #'
16 #' @references Grohs, P., Hornung, F., Jentzen, A. et al.
17 #' Space-time error estimates for deep neural network approximations
18 #' for differential equations. Adv Comput Math 49, 4 (2023).
19 #' \url{https://doi.org/10.1007/s10444-022-09970-2}.
20 #'
21 #' @param nu_1 A neural network.
22 #' @param nu_2 A neural network.
23 #'
24 #' @return A neural network that is the neural network sum of  $\nu_1$  and  $\nu_2$ 
25 #' i.e.  $\nu_1 \oplus \nu_2$ .
26 #'
27 #' Note: We have two versions, an infix version and a prefix version.
28 #' @export
29
30 nn_sum <- function(nu_1, nu_2) {
31   if (nu_1 |> is_nn() &&
32       nu_2 |> is_nn() &&
33       inn(nu_1) == inn(nu_2) &&
34       out(nu_1) == out(nu_2)) {
35     Cpy(2, inn(nu_1)) -> first_third
36     nu_1 |> stk(nu_2) -> mid_third
37     Sum(2, out(nu_1)) -> last_third
38
39     last_third |>

```

```

40     comp(mid_third) |>
41     comp(first_third) -> return_network
42     return(return_network)
43 } else {
44     stop("Only_neural_networks_with_same_end-widths_may_be_summed")
45 }
46 }
47
48 #' Function for calculating neural network sums
49 #'
50 #' @param nu_1 A neural network.
51 #' @param nu_2 A neural network.
52 #'
53 #' @rdname nn_sum
54 #' @export
55 #'
56 `~%nn_sum%` <- function(nu_1, nu_2) {
57     if (nu_1 |> is_nn() &&
58         nu_2 |> is_nn() &&
59         inn(nu_1) == inn(nu_2) &&
60         out(nu_1) == out(nu_2)) {
61         Cpy(2, inn(nu_1)) -> first_third
62         nu_1 |> stk(nu_2) -> mid_third
63         Sum(2, out(nu_1)) -> last_third
64
65         last_third |>
66             comp(mid_third) |>
67             comp(first_third) -> return_network
68         return(return_network)
69     } else {
70         stop("Only_neural_networks_of_same_end_widths_may_be_summed")
71     }
72 }

```

Listing 10.10: R code for i

```

1 #' @title: i
2 #' @description The function that returns the  $\mathbb{i}$  network.
3 #'
4 #' @param d the size of the  $\mathsf{i}$  network
5 #'
6 #' @return returns the  $i_d$  network
7
8 i <- function(d) {
9     list() -> return_network
10    d |> diag() -> W
11    0 |> matrix(d, 1) -> b
12    list(W = W, b = b) -> return_network[[1]]
13    list(W = W, b = b) -> return_network[[2]]
14    return(return_network)
15 }

```

Listing 10.11: R code for Id neural networks

```

1 #' @title: Id
2 #' @description The function that returns the  $\mathsf{Id}_1$  networks.
3 #' @param d the dimension of the  $\mathsf{Id}$  network, by default it is  $\mathsf{1}$ .
4 #'

```

```

5 #' @return Returns the  $\text{Id}_1$  network.
6 #' @export
7
8 Id <- function(d = 1) {
9   if (d %% 1 != 0 ||
10      d < 1
11   ) {
12     stop("d_must_be_natural_numbers")
13   } else if (d == 1) {
14     W_1 <- c(1, -1) |> matrix()
15     b_1 <- c(0, 0) |> matrix()
16     layer_1 <- list(W = W_1, b = b_1)
17     W_2 <- c(1, -1) |> matrix(1, 2)
18     b_2 <- 0 |> matrix()
19     layer_2 <- list(W = W_2, b = b_2)
20     result <- list(layer_1, layer_2)
21     return(result)
22   } else if (d > 1) {
23     Id() -> return_network
24     for (j in 2:d) {
25       return_network |> stk(Id()) -> return_network
26     }
27     return(return_network)
28   } else {
29     stop("Unknown_error")
30   }
31 }

```

Listing 10.12: R code for Tun

```

1 source("R/comp.R")
2 source("R/Id.R")
3
4 #' Tun: The function that returns tunneling neural networks
5 #'
6 #' @param n The depth of the tunnel network where  $n \in \mathbb{N} \cap [1, \infty)$ .
7 #' @param d The dimension of the tunneling network. By default it is assumed to be  $\mathbb{1}$ .
8 #'
9 #' @return A tunnel neural network of depth n. A tunneling neural
10 #' network is defined as the neural network  $\text{Aff}_{1,0}$  for  $n=1$ ,
11 #' the neural network  $\text{Id}_1$  for  $n=1$  and the neural network
12 #'  $\text{Id}_1^{\bullet^{n-2}}$  for  $n > 2$ . For this to work we
13 #' must provide an appropriate  $n$  and instantiate with ReLU at some
14 #' real number  $x$ .
15 #' @export
16 #'
17 Tun <- function(n, d = 1) {
18   if (n %% 1 != 0 ||
19      n < 1 ||
20      d %% 1 != 0 ||
21      d < 1
22   ) {
23     stop("n_and_d_must_be_natural_numbers")
24   }
25   if (d == 1) {
26     if (n == 1) {
27       return(Aff(1, 0))

```

```

28 } else if (n == 2) {
29   return(Id())
30 } else if (n > 2) {
31   Id() -> return_network
32   for (i in 3:n) {
33     return_network |> comp(Id()) -> return_network
34   }
35   return(return_network)
36 }
37 } else if (d > 1) {
38   if (n == 1) {
39     return(Aff(diag(d), 0 |> matrix()))
40   } else if (n == 1) {
41     return(Id(d))
42   } else if (n == 2) {
43     return(Id(d))
44   } else if (n > 2) {
45     Id(d) -> return_network
46     for (i in 3:n) {
47       return_network |> comp(Id(d)) -> return_network
48     }
49     return(return_network)
50   }
51 } else {
52   stop("Unknown_error")
53 }
54 }

```

Listing 10.13: R code for Φ_k

```

1 source("R/comp.R")
2 source("R/Aff.R")
3 source("R/i.R")
4 source("R/aux_fun.R")
5 source("R/activations.R")
6
7 #' The c_k function
8 #'
9 #' @param k an integer in  $\{1, \infty\}$ 
10 #'
11 #' @return the real number  $2^{1-2k}$ 
12 #' @references Grohs, P., Hornung, F., Jentzen, A. et al.
13 #' Space-time error estimates for deep neural network approximations
14 #' for differential equations. Adv Comput Math 49, 4 (2023).
15 #' https://doi.org/10.1007/s10444-022-09970-2
16 #'
17 #' @references Definition 2.3.4. Jentzen, A., Kuckuck, B., and von Wurstemberger, P.
18 #' (2023).
19 #' Mathematical introduction to deep learning: Methods, implementations,
20 #' and theory. \url{https://arxiv.org/abs/2310.20360}.
21
22 c_k <- function(k) {
23   2^{
24     1 - 2 * k
25   } -> result
26   return(result)
27 }
28
29 #' This is an intermediate variable, see reference.

```

```

29 c(0, -1 / 2, -1, 0) |> matrix() -> B
30
31
32 #' C_k: The function that returns the C_k matrix
33 #'
34 #' @param k Natural number, the precision with which to approximate squares
35 #' within \eqn{[0,1]}
36 #'
37 #' @return A neural network that approximates the square of any real within
38 #' \eqn{[0,1]}
39
40 C_k <- function(k) {
41   c(-c_k(k), 2 * c_k(k), -c_k(k), 1) |> matrix(1, 4) -> result
42   return(result)
43 }
44
45
46 #' A_k: The function that returns the matrix A_k
47 #'
48 #' @param k Natural number, the precision with which to approximate squares
49 #' within \eqn{[0,1]}
50 #'
51 #' @return A neural network that approximates the square of any real within
52 #' \eqn{[0,1]}
53 #'
54 A_k <- function(k) {
55   c(2, 2, 2, -c_k(k)) |>
56   c(-4, -4, -4, 2 * c_k(k)) |>
57   c(2, 2, 2, -c_k(k)) |>
58   c(0, 0, 0, 1) |>
59   matrix(4, 4) -> result
60   return(result)
61 }
62
63 #' This is an intermediate variable. See the reference
64 #'
65 c(1, 1, 1, 1) |> matrix(4, 1) -> A
66
67
68 #' The Phi_k function
69 #'
70 #' @param k an integer \eqn{k \in (2, \infty)}
71 #'
72 #' @return The Phi_k neural network
73 #' @references Grohs, P., Hornung, F., Jentzen, A. et al.
74 #' Space-time error estimates for deep neural network approximations
75 #' for differential equations. Adv Comput Math 49, 4 (2023).
76 #' https://doi.org/10.1007/s10444-022-09970-2
77 #'
78 Phi_k <- function(k) {
79   if (k |> is.numeric()) &&
80     k |> length() == 1 &&
81     k >= 1 &&
82     k |> is.finite() &&
83     k %% 1 == 0) {
84     if (k == 1) {
85       C_k(1) |>
86       Aff(0) |>
87       comp(i(4)) |>

```

```

88     comp(Aff(A, B)) -> return_network
89     return(return_network)
90 }
91 if (k >= 2) {
92     C_k(k) |>
93     Aff(0) |>
94     comp(i(4)) -> return_network
95     for (j in (k - 1):1) {
96         A_k(j) |>
97         Aff(B) |>
98         comp(i(4)) -> intermediate_network
99         return_network |> comp(intermediate_network) -> return_network
100     }
101     return_network |> comp(A |> Aff(B)) -> return_network
102     return(return_network)
103 }
104 } else {
105     stop("k_must_a_natural_number")
106 }
107 }

```

Listing 10.14: R code for simulations involving Φ_k

```

1 source("Phi_k.R")
2 source("aux_fun")

```

```

3 source("realization.R")
4 source("activations.R")
5
6 library(ggplot2)
7
8 #' The Phi_k_diff function
9 #'
10 #' @param x the number to be squared in [0,1]
11 #' @param k a parameter for Phi_k in [0, \infty)
12 #'
13 #' @return the 1-norm error between x^2 and Phi_k approximation
14
15 Phi_k_diff <- function(x, k) {
16   return <- (k |> Phi_k() |> rlz(ReLU, x) - x^2) |>
17     abs() -> result
18   return(result)
19 }
20
21 k_values <- c(1, 2, 5, 10, 15, 20)
22 x_values <- seq(-2, 2, length.out = 200)
23 Phi_k_diff_v <- Vectorize(Phi_k_diff)
24
25 Phi_k_diff_data <- expand.grid(k = k_values, x = x_values)
26 Phi_k_diff_data$diff <- Phi_k_diff_v(Phi_k_diff_data$x, Phi_k_diff_data$k)
27
28 library(ggplot2)
29 ggplot(Phi_k_diff_data, aes(x = x, y = diff, color = factor(k))) +
30   scale_y_log10() +
31   geom_line() +
32   geom_line(aes(y = 2^(-2 * k - 2))) +
33   labs(
34     x = "x",
35     y = "log10_of_the_1-norm_error_over_domain_[0,1]"
36   ) -> Phi_k_diff_plot
37 ggsave("Phi_k_properties/diff.png", plot = Phi_k_diff_plot, width = 6, height = 5,
38   units = "in")
39
40 vectorized_Phi_k <- Vectorize(Phi_k)
41 vectorized_param <- Vectorize(param)
42
43 param_data <- data.frame(x = 1:100, y = vectorized_param(vectorized_Phi_k(1:100)))
44
45 ggplot(param_data, aes(x = x, y = y)) +
46   geom_line() +
47   theme_minimal() +
48   xlab("Size_of_k") +
49   ylab("Number_of_parameters") +
50   ggtitle("Plot_of_the_number_of_parameters_of_phi(k)_against_k") +
51   geom_smooth(method = "lm", se = FALSE, color = "blue")
52
53 vectorized_dep <- Vectorize(dep)
54
55 dep_data <- data.frame(x = 1:100, y = vectorized_dep(vectorized_Phi_k(1:100)))
56
57 ggplot(dep_data, aes(x = x, y = y)) +
58   geom_line() +
59   theme_minimal() +
60   xlab("Size_of_k") +

```



```

60 ylab("Depth_of_network") +
61 ggtitle("Plot_of_the_depth_of_φ(k)_against_k") +
62 geom_smooth(method = "lm", se = FALSE, color = "blue")

```

Listing 10.15: R code for Φ

```

1 source("R/Phi_k.R")
2 source("R/i.R")
3 source("R/Aff.R")
4
5
6 #' The Phi function
7 #'
8 #' @param eps parameter for Phi
9 #' @references Grohs, P., Hornung, F., Jentzen, A. et al.
10 #' Space-time error estimates for deep neural network approximations
11 #' for differential equations. Adv Comput Math 49, 4 (2023).
12 #' https://doi.org/10.1007/s10444-022-09970-2
13 #'
14 #' @return neural network Phi that approximately squares a number between
15 #' 0 and 1.
16
17 Phi <- function(eps) {
18   if (eps |> is.numeric() &&
19       eps |> length() == 1 &&
20       eps |> is.finite() &&
21       eps > 0) {
22     (0.5 * log2(1 / eps) - 1) |> ceiling() -> M
23
24     if (M <= 0) 1 -> M
25
26     if (M == 1) {
27       C_k(1) |>
28       Aff(0) |>
29       comp(i(4)) |>
30       comp(Aff(A, B)) -> return_network
31       return(return_network)
32     }
33
34     if (M >= 2) {
35       C_k(M) |>
36       Aff(0) |>
37       comp(i(4)) -> return_network
38       for (j in (M - 1):1) {
39         A_k(j) |>
40         Aff(B) |>
41         comp(i(4)) -> intermediate_network
42         return_network |> comp(intermediate_network) -> return_network
43       }
44       return_network |> comp(A |> Aff(B)) -> return_network
45       return(return_network)
46     }
47   } else {
48     stop("eps_must_be_a_positive_real_number")
49   }
50 }

```

Listing 10.16: R code for simulations involving Φ

```
1 source("Phi.R")
2 source("aux_fun.R")
3 source("realization.R")
4 source("activations.R")
5
6 #' The Phi diff function
7 #'
8 #' @param eps parameter for Phi
9 #' @param x number to be squared
10 #'
11 #' @return the 1-norm error between the result
12 #' and x^2
13
14 diff <- function(eps, x) {
15   (x^2 - eps |> Phi() |> rLz(ReLU, x)) |>
16   abs() -> result
17   return(result)
18 }
19
20 eps_values <- c(1, 0.5, 0.1, 0.01, 0.001, 0.0001)
21 x_values <- seq(0, 1, length.out = 100)
22 vectorized_diff <- Vectorize(diff)
23
24 diff_data <- expand.grid(eps = eps_values, x = x_values)
```

```

25 diff_data$Phi_diff <- vectorized_diff(diff_data$eps, diff_data$x)
26
27 library(ggplot2)
28
29 ggplot(diff_data, aes(x = x, y = eps, z = Phi_diff)) +
30   geom_contour_filled() +
31   ggtitle("Contour_plot_of_the_1-norm_difference_for_values_of_x_and_eps") +
32   theme_minimal() -> Phi_diff_contour_plot
33
34 ggsave("Phi_properties/Phi_diff_contour.png", plot = Phi_diff_contour_plot, width = 6,
35        height = 5, units = "in")
36
37 vectorized_Phi_k <- Vectorize(Phi_k)
38 vectorized_param <- Vectorize(param)
39
40 param_data <- data.frame(x = 1:100, y = vectorized_param(vectorized_Phi_k(1:100)))
41
42 ggplot(param_data, aes(x, y)) +
43   geom_line() +
44   theme_minimal()
45
46
47 vectorized_dep <- Vectorize(dep)
48
49 dep_data <- data.frame(x = 1:100, y = vectorized_dep(vectorized_Phi_k(1:100)))
50
51 ggplot(dep_data, aes(x = x, y = y)) +
52   geom_line() +
53   theme_minimal() +
54   xlab("Size_of_k") +
55   ylab("Depth_of_network") +
56   ggtitle("Plot_of_the_depth_of_φ(k)_against_k") +
57   geom_smooth(method = "lm", se = FALSE, color = "blue")

```

Listing 10.17: R code for Sqr

```

1 source("R/comp.R")
2 source("R/Aff.R")
3 source("R/nn_sum.R")
4 source("R/Phi.R")
5 source("R/aux_fun.R")
6
7 #' @title Sqr
8 #' @description A function that returns the  $\text{Sqr}$  neural networks.
9 #'
10 #' @param q parameter for the Sqr network.  $2 \leq q < \infty$ 
11 #' @param eps parameter for the Sqr network.  $\text{eps} \in (0, 1]$ . You may
12 #' choose epsilon to be greater than 1 but that leads to large errors
13 #'
14 #' @return A neural network that approximates the square of a real number when
15 #' provided appropriate  $\{q, \text{epsilon}\}$  and upon instantiation with ReLU,
16 #' and a real number  $x$ 
17 #' @references Grohs, P., Hornung, F., Jentzen, A. et al. Space-time error estimates
18 #' for deep
19 #' neural network approximations for differential equations. Adv Comput Math 49, 4
20 #' (2023).
21 #' https://doi.org/10.1007/s10444-022-09970-2
22 #'

```

```

21 #'
22 #' @export
23
24
25 Sqr <- function(q, eps) {
26   if (q <= 2 || eps <= 0) {
27     stop("q_must_be_>_2_and_eps_must_be_>_0")
28   } else {
29     2^(-2 / (q - 2)) * eps^(q / (q - 2)) -> delta
30     (eps / 2)^(1 / (q - 2)) -> alpha
31
32     (0.5 * log2(1 / eps) - 1) |> ceiling() -> M
33
34     if (M <= 0) 1 else M -> M
35
36     (Aff(alpha^(-2), 0) |> comp(Phi(delta))) |>
37     comp(Aff(alpha, 0)) -> first_summand
38
39     (Aff(alpha^(-2), 0) |> comp(Phi(delta))) |>
40     comp(Aff(-alpha, 0)) -> second_summand
41
42     first_summand |>
43     nn_sum(second_summand) -> return_network
44
45     return(return_network)
46   }
47 }

```

Listing 10.18: R code simulations involving Sqr

```

1 source("aux_fun.R")
2 source("Sqr.R")
3 source("instantiation.R")
4 source("activations.R")
5 library("tidyverse")
6
7 #' Sqr_diff function
8 #'
9 #' @param q parameter for the Sqr network
10 #' @param eps parameter for the Sqr network
11 #' @param x the number to be squared
12 #'
13 #' @return a neural network that approximately squares x.
14
15 Sqr_diff <- function(q, eps, x) {
16   return <- (Sqr(q, eps) |> rlz(ReLU, x) - x^2) |> abs()
17   return(return)
18 }
19
20 Sqr_diff_v <- Vectorize(Sqr_diff)
21
22 Sqr_data <- expand.grid(
23   q = seq(2.1, 4, length.out = 50),
24   eps = seq(0.01, 2, length.out = 50),
25   x = seq(-5, 5, length.out = 50)
26 )
27
28
29

```

```

30 Sqr_data$diff <- Sqr_diff_v(Sqr_data$q, Sqr_data$eps, Sqr_data$x)
31
32 #' Function to calculate the theoretical upper bounds of the 1-norm error
33 #' over  $\mathbb{R}$ 
34 #'
35 #' @param q parameter for the Sqr network
36 #' @param eps parameter for the Sqr network
37 #' @param x the number to be squared
38 #'
39 #' @return the maximum 1-norm error over  $\mathbb{R}$ 
40
41 diff_upper_limit <- function(q, eps, x) {
42   eps * max(1, abs(x)^q)
43 }
44
45 diff_upper_limit_v <- Vectorize(diff_upper_limit)
46
47 Sqr_data$diff_upper_limit <- diff_upper_limit_v(Sqr_data$q, Sqr_data$eps, Sqr_data$x)
48
49 write_csv(Sqr_data, "Sqr_properties/Sqr_data.csv")
50
51 library(plotly)
52
53 fig <- plot_ly(
54   type = "isosurface",
55   x = Sqr_data$x,
56   y = Sqr_data$q,
57   z = Sqr_data$eps,
58   value = Sqr_data$diff,
59   isomin = 0.0001,
60   isomax = 5,
61   colorscale = "RdBu"
62 ) |>
63   layout(scene = list(
64     xaxis = list(title = "x"),
65     yaxis = list(title = "q"),
66     zaxis = list(title = "eps")
67   )) |>
68   layout(scene = list(legend = list(title = "Diff_from_x^2")))
69
70 fig
71
72 library(ggplot2)
73
74 Sqr_data_aux <- expand.grid(
75   q = seq(2.1, 10, length.out = 100),
76   eps = seq(0.01, 4, length.out = 100)
77 )
78
79 Sqr_data_aux$param <- 0
80
81 for (k in 1:10000) {
82   Sqr_data_aux$param[k] <- Sqr(Sqr_data_aux$q[k], Sqr_data_aux$eps[k]) |> param()
83 }
84
85 experimental_params <- ggplot(Sqr_data_aux, aes(x = q, y = eps, z = log10(param))) +
86   geom_contour_filled() +
87   theme_minimal() +

```

```

88   labs(fill = "Log10_number_of_parameters")
89
90   Sqr_data_aux$dep <- 0
91
92   for (k in 1:10000) {
93     Sqr_data_aux$dep[k] <- Sqr(Sqr_data_aux[k, ]$q, Sqr_data_aux[k, ]$eps) |> dep()
94   }
95
96   experimental_deps <- ggplot(Sqr_data_aux, aes(x = q, y = eps, z = log10(dep))) +
97     geom_contour_filled(alpha = 0.8) +
98     # scale_fill_continuous(breaks = seq(0, max(Sqr_data_aux$dep), by = 1)) +
99     theme_minimal() +
100    labs(fill = "log10_experimental_depths")
101
102
103   param_upper_limit <- function(q, eps) {
104     (((40 * q) / (q - 2)) * ((1 / eps) |> log(2)) + 80 / (q - 2) - 28) |> max(52)
105   }
106
107   dep_upper_limit <- function(q, eps) {
108     ((q / (2 * q - 4)) * log2(1 / eps) + 1 / (q - 2) + 1 / (q - 2) + 1) |> max(2)
109   }
110
111   Sqr_data_aux$param_upper_limit <- 0
112
113   for (k in 1:10000) {
114     Sqr_data_aux$param_upper_limit[k] <- param_upper_limit(Sqr_data_aux[k, ]$q, Sqr_data
115       _aux[k, ]$eps) |>
116       ceiling()
117   }
118
119   param_theoretical_upper_limits <- ggplot(Sqr_data_aux, aes(x = q, y = eps, z = log10(
120     param_upper_limit))) +
121     geom_contour_filled() +
122     theme_minimal() +
123     labs(fill = "Log10_upper_limits_of_parameters")
124
125   Sqr_data_aux$dep_upper_limit <- 0
126
127   for (k in 1:10000) {
128     Sqr_data_aux$dep_upper_limit[k] <- dep_upper_limit(Sqr_data_aux[k, ]$q, Sqr_data_aux
129       [k, ]$eps) |>
130       ceiling()
131   }
132
133   dep_theoretical_upper_limits <- ggplot(Sqr_data_aux, aes(x = q, y = eps, z = log10(dep
134     _upper_limit))) +
135     geom_contour_filled() +
136     theme_minimal() +
137     labs(fill = "Log10_upper_limits_of_depth")
138
139   ggsave("Sqr_properties/param_theoretical_upper_limits.png", plot = param_theoretical_
140     upper_limits, width = 6, height = 5, units = "in")
141
142   ggsave("Sqr_properties/dep_theoretical_upper_limits.png", plot = dep_theoretical_upper
143     _limits, width = 6, height = 5, units = "in")
144
145   ggsave("Sqr_properties/experimental_deps.png", plot = experimental_deps, width = 6,

```

```

140     height = 5, units = "in")
141 ggsave("Sqr_properties/experimental_params.png", plot = experimental_params, width =
      6, height = 5, units = "in")

```

Listing 10.19: R code simulations involving Sqr

```

1 source("R/Prd.R")
2 source("R/Aff.R")
3 source("R/stacking.R")
4 source("R/Tun.R")
5 source("R/aux_fun.R")
6
7 #' @title Pwr
8 #' @description
9 #' A function that returns the  $\{Pwr\}$  neural networks.
10 #'
11 #'
12 #' @param q inside  $\{2, \infty\}$ .
13 #' @param eps inside  $\{0, \infty\}$ .
14 #' @param exponent the exponent which the Pwr network will approximate. Must be
15 #' a non-negative integer.
16 #'
17 #' @return A neural network that approximates raising a number to exponent, when
18 #' given appropriate  $\{q, \epsilon\}$  and exponent when instantiated
19 #' under ReLU activation at  $\{x\}$ .
20 #' @export
21
22
23 Pwr <- function(q, eps, exponent) {
24   if (q <= 2) {
25     stop("Too_small_q,_q_must_be_>=2")
26   } else if (eps <= 0) {
27     stop("Too_small_eps,_eps_must_be_>=0")
28   } else if (exponent %% 1 != 0 || exponent < 0) {
29     stop("Exponent_must_be_a_non-negative_integer")
30   } else {
31     if (exponent == 0) {
32       Aff(0, 1) -> return_network
33       return(return_network)
34     } else if (exponent >= 1) {
35       Cpy(2, 1) -> first_third
36       Pwr(q, eps, exponent - 1) |> stk(Pwr(q, eps, exponent - 1) |> dep() |> Tun()) ->
37         mid_third
38       Prd(q, eps) -> last_third
39       last_third |>
40         comp(mid_third) |>
41         comp(first_third) -> return_network
42     } else {
43       return("Invalid_exponent,_must_be_non-negative_integer")
44     }
45   }
46 }

```

Listing 10.20: R code simulations involving Sqr

```

1 source("Pwr.R")

```

```

2 library(tidyverse)
3
4 #' Pwr_3_diff function
5 #'
6 #' @param q parameter for Pwr_3
7 #' @param eps parameter for Pwr_3
8 #' @param x the number to be cubed
9 #' @param exponent = 3, i.e. cubing a number
10
11 Pwr_3_diff <- function(q, eps, x, exponent = 3) {
12   return <- (Pwr(q, eps, exponent = 3) |> rLz(ReLU, x) - x^3) |> abs()
13   return(return)
14 }
15
16 Pwr_3_diff_v <- Vectorize(Pwr_3_diff)
17
18 Pwr_3_data <- expand.grid(
19   q = seq(2.1, 4, length.out = 50),
20   eps = seq(0.01, 2, length.out = 50),
21   x = seq(-5, 5, length.out = 50)
22 )
23
24 Pwr_3_data$diff <- Pwr_3_diff_v(Pwr_3_data$q, Pwr_3_data$eps, Pwr_3_data$x)
25
26 library(ggplot2)
27
28 ggplot(Pwr_3_data, aes(diff)) +
29   scale_x_log10() +
30   geom_density() +
31   theme_minimal()
32
33 library(plotly)
34
35 fig <- plot_ly(
36   type = "isosurface",
37   x = Pwr_3_data$x,
38   y = Pwr_3_data$q,
39   z = Pwr_3_data$eps,
40   value = Pwr_3_data$diff,
41   isomin = 0.0001,
42   isomax = 5,
43   colorscale = "RdBu"
44 ) |>
45   layout(scene = list(
46     xaxis = list(title = "x"),
47     yaxis = list(title = "q"),
48     zaxis = list(title = "eps")
49   )) |>
50   layout(scene = list(legend = list(title = "Diff_from_x^2")))
51
52 fig
53
54 Pwr_3_data_aux <- expand.grid(
55   q = seq(2.1, 10, length.out = 100),
56   eps = seq(0.01, 4, length.out = 100)
57 )
58
59 Pwr_3_data_aux$param <- 0

```



```

60
61 for (k in 1:10000) {
62   Pwr_3_data_aux$param[k] <- Pwr(Pwr_3_data_aux$q[k], Pwr_3_data_aux$eps[k], exponent
    = 3) |> param()
63 }
64
65 experimental_params <- ggplot(Pwr_3_data_aux, aes(x = q, y = eps, z = log10(param))) +
66   geom_contour_filled() +
67   theme_minimal() +
68   labs(fill = "log10_#_of_parameters")
69
70 Pwr_3_data_aux$dep <- 0
71
72 for (k in 1:10000) {
73   Pwr_3_data_aux$dep[k] <- Pwr(Pwr_3_data_aux[k, ]$q, Pwr_3_data_aux[k, ]$eps,
    exponent = 3) |> dep()
74 }
75
76 experimental_deps <- ggplot(Pwr_3_data_aux, aes(x = q, y = eps, z = log10(dep))) +
77   geom_contour_filled(alpha = 0.8, breaks = seq(0, 10, 1)) +
78   # scale_fill_continuous(breaks = seq(0, max(Pwr_3_data_aux$dep), by = 1)) +
79   theme_minimal() +
80   labs(fill = "log10_depths")
81
82 #' The param_upper_limit function
83 #'
84 #' @param q parameter for the Pwr network
85 #' @param eps parameter for the Pwr network
86 #'
87 #' @return the theoretical upper limit for the number of parameters
88
89 param_upper_limit <- function(q, eps) {
90   4^(4.5) -> first_summand
91   (4^4-1)/3 -> second_summand_a
92   ((360*q)/(q-2))*(log2(1/eps)+q+1)+372 -> second_summand_b
93   first_summand + (second_summand_a * second_summand_b) -> result
94   return(result)
95 }
96
97
98 #' The dep_upper_limit function
99 #'
100 #' @param q parameter for the Pwr_3 network
101 #' @param eps parameter for the Pwr_3 network
102 #'
103 #' @return the theoretical upper limit for the depth
104
105 dep_upper_limit <- function(q, eps) {
106   ((q / (q - 2)) * (log2(1 / eps) + q) - 1) * 3 + 1
107 }
108
109 Pwr_3_data_aux$param_upper_limit <- 0
110
111 for (k in 1:10000) {
112   Pwr_3_data_aux$param_upper_limit[k] <- param_upper_limit(Pwr_3_data_aux[k, ]$q, Pwr_
    3_data_aux[k, ]$eps) |>
113     ceiling()
114 }

```

```

115
116 param_theoretical_upper_limits <- ggplot(Pwr_3_data_aux, aes(x = q, y = eps, z = log10
    (param_upper_limit))) +
117   geom_contour_filled() +
118   theme_minimal() +
119   labs(fill = "Log10_upper_limits_of_parameters")
120
121 Pwr_3_data_aux$dep_upper_limit <- 0
122
123 for (k in 1:10000) {
124   Pwr_3_data_aux$dep_upper_limit[k] <- dep_upper_limit(Pwr_3_data_aux[k, ]$q, Pwr_3_
    data_aux[k, ]$eps)
125 }
126
127 dep_theoretical_upper_limits <- ggplot(Pwr_3_data_aux, aes(x = q, y = eps, z = log10(
    dep_upper_limit))) +
128   geom_contour_filled() +
129   theme_minimal() +
130   labs(fill = "Log10_upper_limits_of_depth")
131
132 ggsave("Pwr_3_properties/param_theoretical_upper_limits.png", plot = param_theoretical
    _upper_limits, width = 6, height = 5, units = "in")
133 ggsave("Pwr_3_properties/dep_theoretical_upper_limits.png", plot = dep_theoretical_
    upper_limits, width = 6, height = 5, units = "in")
134 ggsave("Pwr_3_properties/experimental_deps.png", plot = experimental_deps, width = 6,
    height = 5, units = "in")
135 ggsave("Pwr_3_properties/experimental_params.png", plot = experimental_params, width =
    6, height = 5, units = "in")

```

Listing 10.21: R code simulations involving Sqr

```

1 source("R/Aff.R")
2 source("R/stacking.R")
3 source("R/comp.R")
4 source("R/nn_sum.R")
5
6 #' @title Nrm
7 #'
8 #' @description
9 #' A function that creates the  $\{\mathsf{Nrm}\}$  neural networks that take
10 #' the 1- norm of a  $\{d\}$ -dimensional vector when instantiated with ReLU
11 #' activation.
12 #'
13 #'
14 #' @param d the dimensions of the vector being normed.
15 #'
16 #' @return a neural network that takes the 1-norm of a vector of
17 #' size  $d$  under ReLU activation. This is the neural network that is:
18 #'  $\{d\}$ 
19 #'  $\mathsf{Nrm}^1_1 = \left( \left( \begin{bmatrix} 1 \\ -1 \end{bmatrix}, \right. \right.$ 
20 #'  $\left. \begin{bmatrix} 0 \\ 0 \end{bmatrix} \right), \left( \begin{bmatrix} 1 \\ 1 \end{bmatrix} \right)$ 
21 #'  $\left. \right) \in \left( \mathbb{R}^{2 \times 1} \times \right.$ 
22 #'  $\left. \mathbb{R}^2 \right) \times \left( \mathbb{R}^1 \times 2 \right) \times \mathbb{R}^1$ 
23 #'  $\mathsf{Nrm}^1_d = \mathsf{Sum}_{\{d,1\}} \bullet \left[ \boxminus_{i=1}^d \mathsf{Nrm} \right.$ 
24 #'  $\left. \right]$ 

```

```

25 #' }
26 #'
27 #'
28 #'
29 #' \emph{Note:} This function is split into two cases
30 #' much like the definition itself.
31 #'
32 #' @references Lemma 4.2.1. Jentzen, A., Kuckuck, B., and von Wurstemberger, P. (2023)
33 #' .
34 #' Mathematical introduction to deep learning: Methods, implementations,
35 #' and theory. \url{https://arxiv.org/abs/2310.20360}
36 #' @export
37 #'
38 Nrm <- function(d) {
39   if (d %% 1 != 0 || d < 1) {
40     stop("d_must_be_a_natural_number")
41   } else {
42     if (d == 1) {
43       c(1, -1) |> matrix() -> W_1
44       c(0, 0) |> matrix() -> b_1
45       c(1, 1) |> matrix(1, 2) -> W_2
46       0 |> matrix() -> b_2
47
48       list(W = W_1, b = b_1) -> layer_1
49       list(W = W_2, b = b_2) -> layer_2
50
51       list(layer_1, layer_2) -> return_network
52
53       return(return_network)
54     } else if (d > 1) {
55       1 |> Nrm() -> first_compose
56       for (i in 1:(d - 1)) {
57         first_compose |> stk(Nrm(1)) -> first_compose
58       }
59       Sum(d, 1) |> comp(first_compose) -> return_network
60       return(return_network)
61     } else {
62       stop("Possibly_taking_the_norm_of_an_invalid_sized_array")
63     }
64   }
65 }

```

Listing 10.22: R code simulations involving Sqr

```

1 source("R/Aff.R")
2 source("R/stacking.R")
3 source("R/comp.R")
4 source("R/nn_sum.R")
5 source("R/Id.R")
6
7 #' @title Mxm
8 #' @description The function that returns the  $\text{neural networks}$ .
9 #' These are neural networks of the type:
10 #' \deqn{
11 #' \mathsf{Mxm}^1 = \mathsf{Aff}_{1,0} \quad d = 1 \quad \backslash\backslash
12 #' \backslash\backslash
13 #' \mathsf{Mxm}^2 = \left( \left( \begin{bmatrix} 1 & -1 \\ 0 & 1 \\ 0 & -1 \end{bmatrix} \right. \right.

```

```

14 #' \begin{bmatrix} 0 \\ 0 \end{bmatrix} \right), \left( \begin{bmatrix} 1 & 1 \\ 1 & -1 \end{bmatrix} \right.
15 #' \begin{bmatrix} 0 \end{bmatrix} \right) \right) \quad d = 2 \\
16 #' \\
17 #' \mathsf{Mxm}^{2d} = \mathsf{Mxm}^d \bullet \left[ \boxminus_{i=1}^d \mathsf{Mxm}^2 \right] \quad d > 2 \\
18 #' \mathsf{Mxm}^{2d-1} = \mathsf{Mxm}^d \bullet \left[ \left( \boxminus_{i=1}^d \mathsf{Mxm}^2 \right) \right.
19 #' \boxminus \mathsf{Id}_1 \right] \quad d > 2
20 #'
21 #' }
22 #'
23
24 #' \emph{Note:} Because of certain quirks of R we will have split
25 #' into five cases. We add an extra case for  $d = 3$ . Unlike the paper
26 #' we will simply reverse engineer the appropriate  $\emph{d}$ .
27 #'
28 #' @param d The dimension of the input vector on instantiation.
29 #'
30 #' @return The neural network that will output the maximum of a vector of
31 #' size  $d$  when activated with the ReLU function.
32 #'
33 #' @references Lemma 4.2.4. Jentzen, A., Kuckuck, B., and von Wurstemberger, P. (2023)
34 #' Mathematical introduction to deep learning: Methods, implementations,
35 #' and theory. \url{https://arxiv.org/abs/2310.20360}
36
37
38 #' @export
39
40 Mxm <- function(d) {
41   if (d %% 1 != 0 || d < 1) {
42     stop("d_must_be_a_natural_number")
43   }
44   if (d == 1) {
45     return(Aff(1, 0))
46   } else if (d == 2) {
47     c(1, 0, 0, -1, 1, -1) |> matrix(3, 2) -> W_1
48     c(0, 0, 0) |> matrix() -> b_1
49     c(1, 1, -1) |> matrix(1, 3) -> W_2
50     0 |> matrix() -> b_2
51     list(W = W_1, b = b_1) -> layer_1
52     list(W = W_2, b = b_2) -> layer_2
53     list(layer_1, layer_2) -> return_network
54     return(return_network)
55   } else if (d == 3) {
56     Mxm(2) |> stk(Id()) -> first_compose
57     Mxm(2) |> comp(first_compose) -> return_network
58     return(return_network)
59   } else if ((d %% 2 == 0) & (d > 3)) {
60     d / 2 -> d
61     Mxm(2) -> first_compose
62     for (i in 1:(d - 1)) {
63       first_compose |> stk(Mxm(2)) -> first_compose
64     }
65     Mxm(d) |> comp(first_compose) -> return_network
66     return(return_network)
67   } else if ((d %% 2 != 0) & (d > 3)) {

```

```

68 (d - 1) / 2 -> d
69
70 Mxm(2) -> first_compose
71 for (i in 1:(d - 1)) {
72   first_compose |> stk(Mxm(2)) -> first_compose
73 }
74 first_compose |> stk(Id()) -> first_compose
75 Mxm(d + 1) |> comp(first_compose) -> return_network
76 return(return_network)
77 } else {
78   stop("Possibly_taking_max_of_vector_of_length_0")
79 }
80 }

```

Listing 10.23: R code simulations involving Tay

```

1 source("R/Pwr.R")
2 source("R/nn_sum.R")
3 source("R/scalar_mult.R")
4 source("R/Aff.R")
5
6 #' The Tay function
7 #'
8 #' @param f the function to be Taylor approximated, for now "exp", "sin"
9 #' and "cos". NOTE use the quotation marks when using this arguments
10 #' @param n the extent of Taylor approximations, a natural number
11 #' @param q argument for the Pwr networks  $\in (2, \infty)$ 
12 #' @param eps argument for the Pwr networks  $\in (0, \infty)$ 
13 #'
14 #' @return a neural network that approximates the function f
15
16 Tay <- function(f, n, q, eps) {
17   if (n % 1 != 0 || n < 0) {
18     stop("Number_of_Taylor_iteration_must_be_a_non_negative_integer")
19   } else if (q < 2 || eps < 0) {
20     stop("q_must_be_>_2_and_eps_must_be_>_0")
21   } else if (f != "exp" && f != "sin" && f != "cos") {
22     stop("For_now,_only_Taylor_approximations_for_exp,_sin,_and_cos_is_available")
23   } else {
24     if (f == "exp") {
25       (1 / factorial(0)) |> slm(Pwr(q, eps, 0)) -> return_network
26       if (n == 0) {
27         return(return_network)
28       }
29       for (i in 1:n) {
30         return_network |> nn_sum((1 / factorial(i)) |> slm(Pwr(q, eps, i))) -> return_
31           network
32       }
33       return(return_network)
34     }
35     if (f == "cos") {
36       1 |> slm(Pwr(q, eps, 0)) -> return_network
37       if (n == 0) {
38         return(return_network)
39       }
40     }
41     for (i in 1:n) {
42       ((-1)^i) / factorial(2 * i) -> coeff

```

```

43     return_network |> nn_sum(coeff |> slm(Pwr(q, eps, 2 * i))) -> return_network
44   }
45   return(return_network)
46 }
47
48 if (f == "sin") {
49   Tay("cos", n, q, eps) -> return_network
50   return_network |> comp(Aff(1, -pi / 2)) -> return_network
51   return(return_network)
52 }
53 }
54 }

```

Listing 10.24: R code simulations involving Etr

```

1 #' @title Trp
2 #' @description The function that returns the  $\text{Trp}$  networks.
3 #'
4 #' @param h the horizontal distance between two mesh points
5 #'
6 #' @return The  $\text{Trp}$  network that gives the area
7 #' when activated with ReLU and two meshpoint values  $x_1$  and  $x_2$ .
8 #' @export
9
10 Trp <- function(h) {
11   if (h |> is.numeric() &&
12       h |> length() == 1 &&
13       h |> is.finite() &&
14       h > 0) {
15     c(h / 2, h / 2) |> matrix(1, 2) -> W
16     0 |> matrix() -> b
17     list(list(W = W, b = b)) -> return_network
18     return(return_network)
19   } else {
20     stop("h_must_be_a_positive_real_number")
21   }
22 }
23
24 #' @title Etr
25 #' @description The function that returns the  $\text{Etr}$  networks.
26 #'
27 #' @param n number of trapezoids to make. Note this will result in a set of
28 #' trapezoids.
29 #' Note that this will result in n+1 meshpoints including the starting a and
30 #' ending b
31 #'
32 #' \emph{Note: } Upon instantiation with any continuous function this neural
33 #' network must be fed with  $n+1$  real numbers representing the values
34 #' of the function being approximated at the  $n+1$  meshpoints which are
35 #' the legs of the  $n$  triangles as stipulated in the input parameters.
36 #'
37 #' @param h width of trapezoids
38 #'
39 #' @return an approximation for area of the integral
40 #' @export
41
42 Etr <- function(n, h) {
43   if (h |> is.numeric() &&
44       h |> length() == 1 &&

```

```
45 h |> is.finite() &&
46 h > 0 &&
47 n %% 1 == 0 &&
48 n > 1) {
49   c(h / 2, rep(h, n - 1), h / 2) |>
50     matrix() |>
51       t() -> W
52   0 |> matrix() -> b
53   list(list(W = W, b = b)) -> return_network
54   return(return_network)
55 } else {
56   stop("n_must_be_a_natural_number_and_h_must_be_a_positive_real_number.")
57 }
58 }
```